

NORTEK MANUALS

The Comprehensive Manual for ADCPs



AWAC | Aquadopp | Aquadopp deepwater | Aquadopp Profiler | Aquadopp Profiler Z-cell | 2D Horizontal Profiler

Table of Contents

Ch. 1	Introduction	8
Ch. 2	Principles of Operation	11
2.1	Currents	13
	The Doppler Effect	13
	Narrowband Profilers	14
	Pulse Coherent Profilers (AquaPro HR)	15
	Doppler Beams	16
	Sensors	16
	Pressure	16
	Temperature	16
	Magnetometer and Tilt	16
	Sensor Calibration	17
	Measurement Area	18
	Current Meters	18
	Current Profilers	19
	Summary	20
	Orientation	21
	Pitch, Roll and Heading	21
	Coordinate System	22
	Operational Considerations	24
	Sampling Strategies	24
	Modes of Operation	25
	Velocity Uncertainty	25
	Maximum Range and Signal Strength	27
	Ocean Scattering	28
	Sidelobe Interference	29
	Speed of Sound	30
	Practical Considerations for HR AquaPro	31
	Data	34
	Mechanical and Processing Methods to Ensure Quality Profiles	37
	Configuration	37
	Deployment	39
	Data Processing	40
2.2	Waves	42
	Background	42
	Sampling	44
	Midlife Wave Sampling	45

	Signature Wave Sampling	47
	Statistical Approach	48
	Time Series	49
	Spectral Analysis	49
	Processing Methods	50
	PUV	50
	MLM	51
	Acoustic Surface Tracking (AST)	54
	MLMST	55
	SUV	56
	Wave Parameters	57
	Non-Directional	57
	Directional	58
	Wave Parameters (Processed)	59
	Measurement Errors, Uncertainties and Corrections	61
	Additional Reading	62
Ch. 3	Service Manual	64
3.1	Function Testing	66
	Initial Test Setup	66
	Power	66
	Converter	67
	Connect cables	67
	Start the appropriate software	68
	Sensor Checks	69
	Temperature	70
	Tilt	70
	Compass	71
	Pressure	71
	Noise floor and Pinging Checks	72
	Beam Amplitude and Velocity Checks	72
	Amplitude	73
	Velocity	73
	Range Check (Aquadopp and Aquadopp DW)	74
	Test Recorder Function	74
	Battery degaussing	75
3.2	Customer Calibration	75
	Compass Calibration	76
	Pressure Offset	77
3.3	Changing a Battery Pack	78
	Aquadopp and AquaPro	79
	AWAC and Continental	79
3.4	Upgrade Firmware	80

	AquaPro HR to AquaPro	80
3.5	Erase Recorder	81
3.6	Mechanical Aspects and Maintenance	81
	Instrument Care	81
	Connector Care	82
	Cable Care	82
	Replace Desiccant Bag	82
	O-ring Care	83
	Securing Screws	83
	Biofouling	84
3.7	Cables and Wires	85
	Using Long Cables	87
	Harness (internal wiring)	88
3.8	Advanced Servicing	89
	Changing a Transducer Head	90
	Replacing Heads/Boards	90
	Update Headfile	90
	Accessing the Circuit Board	91
	Installing a Memory Board	92
	Midlife - Aquadopp, AquaPro and AWAC	92
	Pre-midlife - Aquadopp and AquaPro	94
	Older Paradopps	95
	Continental and Pre-midlife AWAC	95
	Installing a DC/DC	96
	Changing the Wiring Harness	97
	Changing the Output Power for Auxiliary Sensors	98
	Midlife Electronics	98
	Pre-midlife Electronics	98
Ch. 4	Mounting Guideline	99
4.1	Forces Acting on a Deployment	101
	Buoyancy	101
	Tension	101
	Drag	101
4.2	Mounting Alternatives	102
	Stand-Alone	103
	In-line Mooring	103
	Subsurface Buoy	105
	Bottom Mount	106
	Online	106
	Offshore Cable	106
	Inductive Modem	109
	Acoustic Modem	110

4.3	Equipment	111
	Standard Equipment	111
	Surface Buoy	111
	Subsurface Buoy	111
	Mooring Line	112
	Anchor	113
	Connecting Hardware	114
	Bottom Frame	114
	Ancillary Equipment	115
	Pop-up Buoy	115
	Acoustic Release	115
	Gimbal	115
	Mounting Device	116
	AquaFin	116
	AquaClamp	116
4.4	Special Considerations	116
	Measuring Waves	116
	Natural Frequency of Subsurface Buoys	117
	Damping Factor	118
	Mooring Vibrations	119
	Corrosion	119
4.5	Check lists	120
Ch. 5	System Integrator - Light	123
5.1	Analog Inputs	124
	Example of Calculation of Energy Consumption	125
5.2	Analog Outputs	126
	Aquadopp Current Meters	126
Ch. 6	Troubleshooting Guide	128
6.1	Communication Problems	130
	Test with Battery and Power Supply	130
	Cable test	131
	Serial-to-USB Converter	131
	Baud Rate	131
	Serial COM port	131
	Break Response	132
	Loop Back Test	132
	Test with both RS422 and RS232 communication	133
	Check Current Drain	133
	Check Fuse	134
	Check LED Indications	134
	Check Interface Box	134
	Checksum Error	135

	Flash Corrupt	135
6.2	Instrument Stopped During Data Collection	135
	Power	135
	Full Recorder	136
6.3	Suspicious Data	136
	Signal Strength	136
	Boundaries	137
	Grounding Problems	138
	AquaPro HR: Phase Wrapping	138
	Error and Status Codes	138
	Vessel Mounted Current Profiler Data	140
	Unrealistic Values	140
	No or Intermittent Data	140
	Calibration Sanity Check	141
6.4	Returning Instruments for Repair	142
Ch. 7	Appendices	144
7.1	Appendix A - Final Test Checklist	145
7.2	Appendix B - Trouble Report - VMCP	146
7.3	Appendix C - Example of Proforma Invoice	147

Introduction

SECTION



1

1 Introduction

With every instrument comes a Quick Guide that provides you with the basic information you need to get your instrument up and running as quickly as possible. The document you are reading at this moment is a collection of manuals, covering Principles of Operation, a Service Manual, Mounting Guidelines, a Troubleshooting Guide, and a Light System Integrator Manual. The idea is that the Quick Guide contains the basic information needed to get going, and only that. If you are interested in learning more about the instruments, how they can be deployed, how to work inside them, or what to do when encountering a problem, you will find a lot of information in this document. Inevitably, these manuals will overlap on certain points.

The [Principles of Operation](#) is divided into two parts. The first part covers the underlying principles for obtaining current measurements. The Doppler Effect is described, and the individuality and special features of the instruments are highlighted. Some limitations and special considerations for measurements are presented at the end. The second part focuses on waves and wave processing methods. Special wave properties are described to explain how it is possible to measure and obtain wave parameters, and what limitations that exist. The wave parameters of interest, both directional and non-directional, are described, and the different processing methods for obtaining these parameters are presented.

The [Service Manual](#) describes tests and verification procedures that should be done ahead of a deployment, tips and general recommendations for getting the highest quality data, and general practical considerations regarding deployment planning. The purpose of the Service Manual is also to aid in re-configuration tasks, and is meant to supplement the existing Troubleshooting Guide and Principles of Operation manuals.

The [Mounting Guideline](#) covers mounting alternatives and considerations that should be made, equipment, and general tips.

The [Troubleshooting Guide](#) contains our years-long experience in where to start looking when an instrument is not behaving as intended.

The [System Integrator - Light](#) covers how to use Nortek instruments together with other instruments. For a more comprehensive integration, check out the [System Integrator Manual](#). This manual provides the information needed to control a Nortek product with a non-PC controller. It is aimed at system integrators and engineers with interfacing experience. Code examples are provided in C. The document's scope is limited to interfacing.

Instrument software help

The instrument software has been designed to aid you in the planning, execution and recovery of your instrument deployment. The software also contains a test section, including all functions required to operate the instrument. An on-line help system is integrated in the software, containing answers to questions you may have on how to use the software. Click **Help > Help Topics**.

Nortek online

At our website, www.nortekgroup.com, you will find technical support, user manuals, and the latest software and firmware. General information, technical notes, and user experience can also be found here.

Nortek FAQ

Our old forum where users from all over the world met to discuss and shared their experience with Nortek instruments has been converted to an FAQ section. If you have comments, questions, application tips, suggestions for improvements, or simply want to learn from others or share your own experience, we encourage you to [comment on the relevant FAQ](#) or [start a topic in our new forum](#).

Your feedback is appreciated

If you find errors, omissions or sections poorly explained, please do not hesitate to contact us. We appreciate your comments and your fellow users will as well.

Contact Information

We recommend first contacting your local sales representative before the Nortek main office. If you need more information, support or other assistance, you are always welcome to contact us or any of our subsidiaries by email, phone or fax.

Email: inquiry@nortekgroup.com for general inquiries or support@nortekgroup.com for technical support

Phone: +47 67 17 45 00

Fax: +47 67 13 67 70

You can also write us at:

Nortek AS
Vangkroken 2
1351 RUD
Norway

Version/revision	Date	Comments
Version 2017.1	10.2017	New design, updates for IMU, orientation, etc.
Version 2018.1	29.11.2018	ADCP only update
Version 2021.1	09.02.2021	Major/minor changes and additions
Version 2021.2	23.03.2021	Minor corrections
Version 2021.3	13.09.2021	Minor corrections
Version 2022.1	18.03.2022	Minor corrections and layout changes
Version 2022.2	22.09.2022	Minor corrections

Principles of Operation

SECTION

2

2 Principles of Operation

This section covers

- ✓ Basic Doppler principles
- ✓ Difference between our instruments with focus on measurement method and area
- ✓ Coordinate systems and tilt
- ✓ How wave measurements are made
- ✓ Different processing methods

Our products are based on the acoustic Doppler principle and span from single point turbulence sensors to long range current profilers. The instruments can be divided into three main groups:

Current Meters: The Aquadopp Current Meter and Deep Water Aquadopp Current Meter (DW) measure water currents at one level. The Aquadopp Current Meter, henceforth called the Aquadopp, has three acoustic transducers that can be arranged in a variety of head configurations. Current meters are simple to use and appropriate when only one measurement point is required, or when measurements at great depths are of interest. The Aquadopp and Aquadopp DW are available as 2 MHz systems. The deepwater Aquadopp is designed for deployments down to 3000/6000 m. The current meters are equipped with temperature, compass, tilt and pressure sensors, and an internal battery pack that enables autonomous deployments for very long periods of time.

Current Profilers: The Aquadopp Profiler (AquaPro) and the Acoustic Wave and Current Profiler (AWAC) measure current and direction in multiple layers through the water column. Nortek makes current profilers with ranges from a few cm (High Resolution [HR] mode) to several hundred meters, available in frequencies of 2, 1, 0.6, or 0.4 MHz (for the AquaPro, the latter three frequencies for the AWAC) and 2/1 and 2/0.6 MHz (Z-cell profiler). The AWAC may also be used as an operational Vessel Mounted (VM) system. The Aquadopp Z-cell is an extension of the AquaPro; it has the same specifications, but with the added capability of measuring the current at the level of the instrument ("Cell Zero"). The Current Profilers are equipped with temperature, compass, tilt and pressure sensors, and can also have an internal battery pack.

Wave Sensors: Some of the instruments can be used as wave gauges in addition to current meters. Wave systems measure both wave height and direction. The AWAC is perhaps the most respected, sophisticated and frequently used acoustic Doppler profiler and directional wave gauge in the world. The AWAC is able use a combination of the Acoustic Surface Tracking (AST), velocity data and pressure data to make high quality wave measurements, and may be deployed up to 100 m below the surface. The AquaPro is also able to burst sample the pressure sensor and one cell of current velocity. The Aquadopp may be regarded as a more cost effective directional wave gauge. The AquaPro and Aquadopp are PUV wave measurement instruments.

2.1 Currents

The average current profile gives measurements of current speed and direction in multiple layers throughout the water column. Different bodies of water will have different phenomena governing the majority of water movement, but the most typical force is the tidal cycle. In most areas the currents vary little in the horizontal plane, but may differ more in vertical layers, hence the idea of cells. Depending on the weather conditions, currents may have greater velocities near the surface due to wind drag. In the following section, the concept of current measurements are divided into relevant topics.

2.1.1 The Doppler Effect

Nortek instruments measure the velocity of water by utilizing a physical principle called the Doppler Effect, illustrated below. The Doppler Effect is the change in frequency of a wave when a wave source moves with respect to an observer, or when the observer itself moves relative to the wave source. For example, if a train whistle is heard when standing still, the sound waves will travel with the same speed in every direction, and an observer (not moving) will hear a uniform sound. When the train starts to move towards the observer, each sound wave originates from a position that is one step closer to the observer for every second. The time it takes for the sound wave to reach the observer declines steadily, i.e. the waves arrive with decreasing time intervals, and this can be construed as a frequency shift in the sound wave. Based on this perceived frequency shift, the speed of the train can be measured. When the observer moves and the source of the waves is still, the Doppler frequency shift still appears because the velocity of the sound wave relative to the observer is changed.

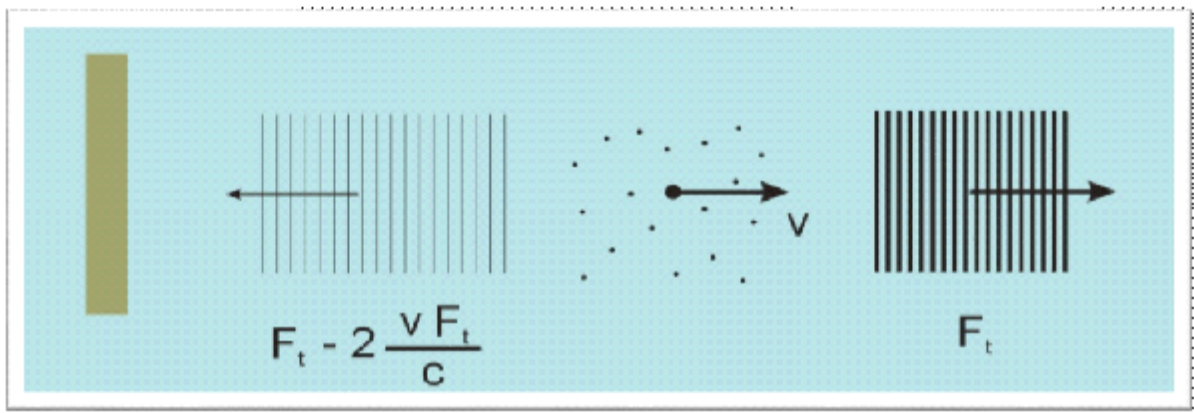

Figure: An acoustic echo reflected from moving particles is shifted in frequency (Doppler shifted) in proportion to the particle velocity. F_t is the frequency of the transmitted pulse

There are many ways to measure the Doppler Effect, each with its own advantages and drawbacks. In earlier days, Nortek implemented a narrowband auto-covariance method because it has been established as robust, reliable and accurate. Auto-covariance is a statistical method similar to the covariance method, which calculates how much two variables change together. The auto-covariance covers the covariance of time series; a variable is compared to the time-shifted version of itself. The Signature Series covers broadband processing, and this topic is covered in other manuals (check the web).

2.1.2 Narrowband Profilers

Narrowband acoustic Doppler instruments transmit a short pulse of sound (“ping”) of constant frequency into the water, listen to its echo and measure the change in pitch or frequency of the echo. The difference in frequency between the transmitted and the received pulses is proportional to the velocity of the water.

The emitted sound pulse does not reflect from the water itself, but from small suspended particles. These particles are typically phyto- or zooplankton, suspended sediment, or small air bubbles. The scattering materials float passively in the water and it is assumed that they move with the same speed as the water - the measured velocity of the particles is the velocity of the water surrounding the particle. This is a key assumption for the Doppler approach to measure water velocity.

The sound pulse scatters in all directions when it hits the particles. Most of the sound continues forward, but a small amount is reflected back to the source. The figure below describes the Doppler Effect; the illustrated pulse is shifted/compressed to a higher frequency upon return. This shift indicates that the reflecting particle moves toward the instrument. In the opposite case, when the target moves away, the received signal pulse is stretched compared to the transmitted pulse, i.e. has a lower frequency. When the target is stationary, the received signal will have the same frequency as the transmitted pulse. Only changes in the distance between the beam and the scattering particle can be measured since this is the only motion that affects the Doppler Shift. It does not sense the velocity perpendicular to the beam at all since there is no change in distance between the scattering particle and the beam. The Doppler Shift is thus used to calculate the velocity of the water along the path of the acoustic pulse. The following equation expresses this:

$$V = \frac{F_{Doppler}}{F_{source}} \times \frac{C}{2}$$

Here, V is the current velocity, $F_{Doppler}$ is the change in received frequency (the Doppler Shift), F_{source} is the frequency of the transmitted wave, and C is the speed of sound in water. The first term on the right hand side of the equation tells us the same as the figure below illustrates; if the distance between the transducer and the scattering target increases (decreases), the frequency of the reflected pulse decreases (increases). The rightmost term includes the speed of sound, so that the actual velocity is calculated.

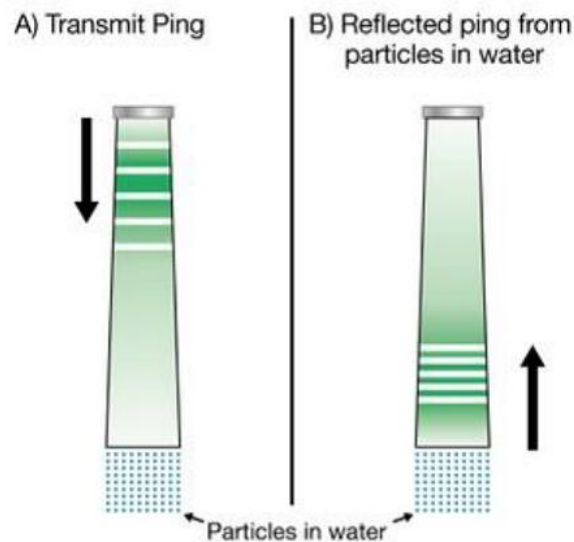

Figure: Illustration of a pulse transmitted (a) and reflected by particles in the water (b)

2.1.3 Pulse Coherent Profilers (AquaPro HR)

A pulse coherent profiler must transmit at least two pulses in order to obtain a measure of the current velocity, as opposed to the method described above, where a measurement of radial speed along the acoustic beams is obtained through the calculated Doppler shift from one emitted pulse. The Aquadopp HR Profiler, the Vector, the Vectrino and the Vectrino Profiler are Pulse coherent instruments. Information about the velocimeters can be found in the [Comprehensive Velocimeter Manual](#). The backscattered signal is range-gated (separated into different segments for independent processing) for each pulse. After the second pulse is range-gated, the phase difference between the backscattered signals is calculated for each range cell. The phase difference is a direct measure of the velocity, expressed as

$$V = \frac{\Delta\phi C}{4\pi F_{source}\Delta t}$$

Here, V is the current velocity, $\Delta\phi$ is the phase difference, F_{source} is the transmitted frequency, and Δt is the time difference between two consecutive pulses.

The Doppler phase shift is computed using the covariance method. By computing the complex covariance of the two return signals, the Doppler phase shift can be calculated by taking the four quadrant arctangent (atan2 in most programming languages) of the real and imaginary parts of the covariance function. This restricts solving the phase difference within the range of $[-\pi, \pi]$. The calculation of ϕ is beyond the scope of this manual, but the impacts of using this method is important. It introduces the problem of ambiguous determination of the phase shift; if the phase difference goes outside the range of $\pm\pi$, the measurement uniqueness is lost, something known as velocity ambiguity. For example, a sine wave with phase $-\pi$ looks the same as a sine wave with phase π .

Pulse coherent systems are typically used for difficult measurement situations such as turbulence measurements, very slow or low energy flows, and rapidly varying flows requiring high single ping accuracy. They can work well in areas with high shear, near boundaries, under breaking waves, and

many other situations. Pulse coherent data from single or small ensemble average measurements are useful because of the individual measurement accuracy and low noise. Pulse coherent profilers can measure in far smaller cell sizes (on the order of 1 cm) providing more details of the flow than standard Doppler systems.

The [Pulse Coherent Primer](#) document that discusses the basic theory and operations of the instrument using pulse coherent methods is highly recommended reading for users of pulse coherent profilers. It provides explanations and examples of common issues such as ambiguity velocity, correlation and coordinates transforms.

2.1.4 Doppler Beams

The Doppler current sensors covered in this manual use large transducers (relative to the wavelength of the sound) to obtain narrow acoustic beams. Narrow beams are essential for obtaining good data. The beamwidth of each frequency instrument can be found in the technical specifications available online. The newer Signature series of instruments use broadband pulses, described in detail in [Principles of Operation - Signature](#).

One beam is required for each velocity component, so to obtain data for three velocity components (e.g. east, north and up), three beams are required. The beams measure the velocity of particles in three different places. The instrument combines the three along-beam velocities and uses the relative orientation of the transducers and basic trigonometry to calculate the 3D water velocity.

Mono-static vs bi-static systems

Mono-static systems (covered in this document) use the same transducer to both transmit and receive signals. Bi-static systems (covered in [Comprehensive Velocimeter Manual](#)) use one center transducer to emit the pulse(s) and 3 or 4 outer transducers to receive the echo.

2.1.5 Sensors

2.1.5.1 Pressure

The pressure sensor measures the hydrostatic pressure and reports in units of dBar. Information about the pressure is of particular importance when measuring waves. Aquadopps, Aquadop Profilers and AWACs sample pressure once each second. The instrument does not set the pressure offset automatically, so this must be done using the relevant instrument software just before deployment to correct for local atmospheric pressure. For more about this, look at the section [Set Pressure Offset](#). Note that a Nortek pressure sensor cannot measure less than 0 dBar.

2.1.5.2 Temperature

The instruments use the speed of sound to convert time to distance, and since speed of sound depends on temperature, this information is of vital importance. The temperature is measured by a thermistor embedded in the head and reported in degrees Celsius. The instruments sample temperature every second. The time response is about 10 minutes.

2.1.5.3 Magnetometer and Tilt

Nortek's compass is a system including a 3-axis magnetoresistive magnetometer, a liquid tilt sensor, algorithms to convert data from these sensors into heading and instrument tilt, and a calibration algorithm. The magnetometer measures the magnitude of three components of the earth's magnetic field,

and the tilt sensor measures two components of tilt and detects up/down orientation. All Nortek products (with compass) combine this information to compute the instrument's tilt and heading, then uses the tilt and heading to correct measured velocities to [earth \(ENU\) coordinates](#).

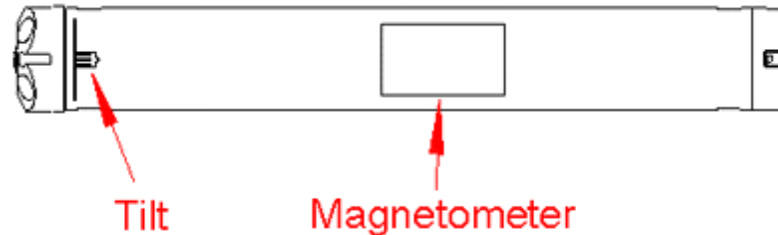

Figure: Magnetometer and tilt

Tilt sensor

The tilt sensor measures the orientation of the instrument and comes in two versions; vertical orientation and horizontal orientation. The tilt sensor in the instruments are good to $\pm 30^\circ$, but the accuracy is significantly better for smaller tilt angles because of the technology used to measure tilts.

If an instrument with vertical orientated tilt sensor is to be mounted horizontally, the tilt sensor data will be unusable and the data would need to be collected in [XYZ or BEAM coordinates](#). It is possible to change the orientation of the sensor, but the instrument would need to be returned to Nortek. In addition to the physical replacement of the tilt sensor, the instrument would need to go through calibration.

The tilt sensors measure tilt relative to earth gravity. If the instrument is moving (e.g. when mounted on a buoy), the tilt sensor cannot differentiate the acceleration from the buoy from the acceleration of gravity.

Magnetometer

Magneto-resistive (MR) magnetometers sense magnetic fields with thin strips of a metal alloy whose electrical resistance varies with a change in applied magnetic field. These sensors have a well-defined axis of sensitivity and are mass-produced in integrated circuits. Nortek's compass includes three MR sensors, one each for X, Y and Z components.

Each compass system is calibrated in the factory to quantify the characteristic response of the individual components and of the system as a whole. When it leaves the factory, each system can measure its tilt and the direction of its magnetic field vector accurately, anywhere in the world.

Users disturb the magnetic field near the instrument when they deploy. Adding a battery pack and mounting the instrument with deployment hardware adds magnetic materials that change the earth's field at the instrument. The user's [compass calibration procedure](#) quantifies this magnetic disturbance, and the instrument's compass algorithm then corrects for it to obtain accurate heading.

2.1.5.4 Sensor Calibration

Calibration is a verification that a sensor or instrument is operating within the specified uncertainty at the time of calibration. The calibration requirements for a sensor or instrument are not decided by Nortek, but rather by the user. If you need to state that your system or measurements have a known uncertainty for quality assurance, then you may choose to send your instrument(s) back to Nortek for re-calibration at whatever interval your quality assurance requirements dictate. You may also wish to use an external

temperature or pressure sensor if you need a lower uncertainty than that to which the instrument's integrated sensors are calibrated.

Please [contact Nortek Support](#) if you wish to send your instrument for re-calibration.

2.1.6 Measurement Area

The instruments measure the velocity in three dimensions. Each transducer generates a sound pulse and measures the Doppler shift of the returned signal. The Doppler shifts from all the three beams are combined to calculate the 3D velocity in a specified depth layer, a sampling volume or in a profile covering a defined depth. The measurement area varies according to the transducer geometry, the frequency used, blanking distance, deployment method etc. In this section, the difference between the current meters and the current profilers regarding measurement area is in focus.

2.1.6.1 Current Meters

Current meters measure the water current at one defined sampling area. The volume of the body of water covered by the three beams is dependent on the distance from the instrument, the blanking, the cell size and the beam geometry. In the figure below, you can see the measurement cell location of an Aquadopp DW. The same configuration defines the measurement location for the Aquadopp.

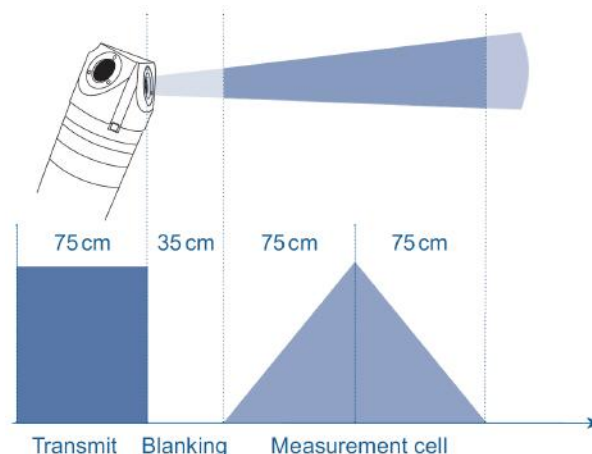

Figure: Blanking distance and weighted return signal within the measurement volume for an Aquadopp DW

Remember that in this mono-static system the transducer works as both a transmitter and receiver. The transducer vibrates to produce a sound wave. It does not stop vibrating immediately after the supplied energy has stopped; the vibrations are damped with time. This is called ringing. The distance the sound travels during the attenuation of the ringing is the minimum blanking distance. Thus, blanking is the time during which no measurements take place, essentially to give the transducers time to settle before the echo returns to the receiver. The size of the blanking area is user-selectable in the software, but will always have a minimum value depending on the instrument frequency..

One measurement cell represents the average of the return signal for a given period. The cell size and the transmit pulse are of equal size, which means that the response from the transmit pulse will extend over 150 cm. Internal processing will weight the return echo, and the measurement (or the return signal) will be shaped like a triangle due to convolution. The weighting of the measurement is shown in the figure above.

The beam geometry is determined by the orientation of the acoustic beams. A variety of sensor heads are available for the Aquadopp; please ask Nortek for more information on the options. The flexible transducer design is the key to the wide range of Aquadopp applications. The Aquadopp beam geometry is one of its innovative features; it gives you more flexibility with mounting options. For example it allows you to design your mooring to minimize disturbance caused by the mooring itself (more on this in the [Mounting Guideline](#)).

2.1.6.2 Current Profilers

Current profilers measure current speed and direction in multiple distances (multiple depth cells) from the transducers. The figure below shows the profiling range divided into a few regions. The current profilers have three beams oriented at 25° off the vertical axis, and equally spaced at 120° azimuth angles.

Closest to the transducers is a region called the blanking, with the already described purpose of minimizing the interference from ringing in the data. The size of the blanking varies with acoustic frequency; lower frequency instruments typically have longer blanking distance (see Summary table below). The software sets a default blanking distance, but you can adjust the range out further. The Aquadopp Z-Cell solves the possible problem of losing near-instrument measurements. This is accomplished by including three horizontally oriented transducers that measure a 2D current velocity at the level of the instrument.

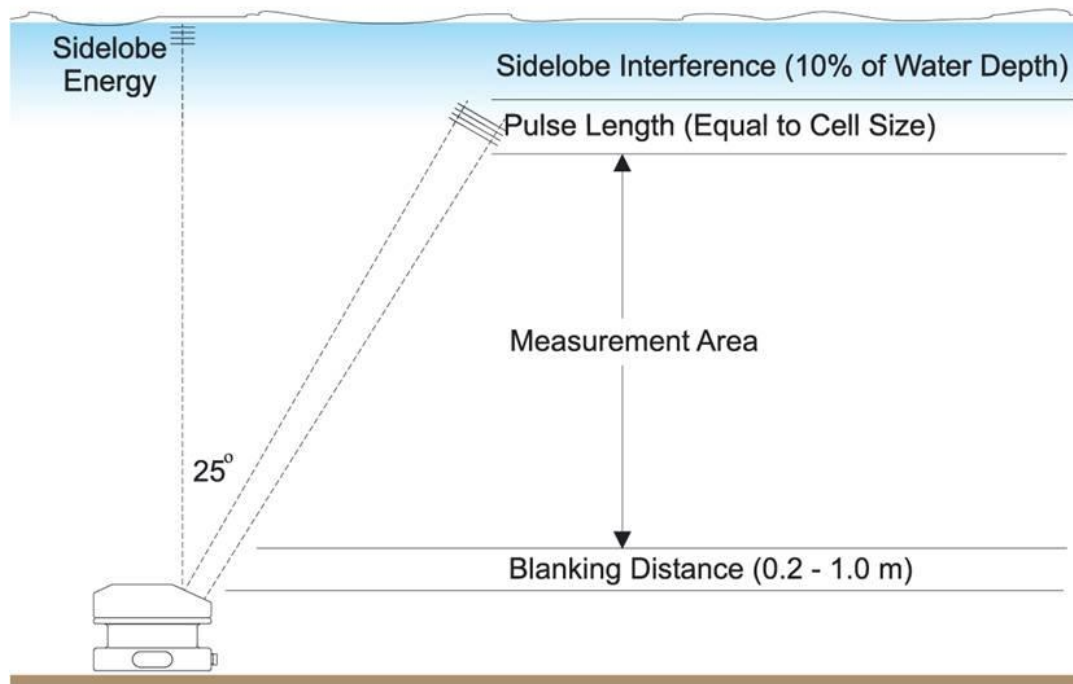

Figure: The AWAC profiling range broken down into different regions.

The current profiler will make velocity measurements in the Measurement Area (see figure above). The measurement location is a function of the time at which the sound pulse hits particles and is reflected back to the source. The continuous return signal from the transmitted sound wave is received and amplified before it is sectioned up into smaller segments in the instrument, where each segment corresponds to a depth cell. Each cell represents the average of the return signal for a given period,

according to the user-specified cell size. The velocities from the three beams are combined at each cell so that the 3D velocity is calculated, making a velocity profile of the measurement area.

When trying to determine the exact position of the depth cells, consider the following:

- The size and location of the depth cell are determined both by the transmit pulse length and the size of the received echo segment (the "receive windows" – how long the instrument listens).
- Mathematically, the size of the depth cell is the convolution of the transmit pulse length and the receive window.
- The depth cell does not give equal weight to all points within the cell but is weighted towards the middle. When the transmit pulse and the receive pulse are matched, the weighting function has a triangular shape.
- Nortek instruments use a transmit pulse that is equal to the user specified cell size, with the consequence that the return signal in adjacent cells overlap.

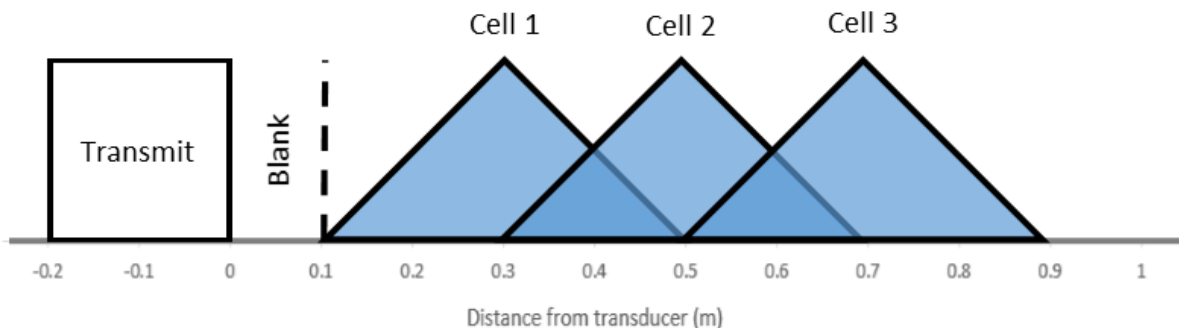

Figure: A series of return signals where the separation between adjacent cells is equal to the length of the transmit pulse. Thi figure shows the triangular weighting given to measurements within each cell, and how these measurement areas overlap due to the transmit pulse length.

The n^{th} cell is centered at a distance equal to:

$$\text{center of } n^{\text{th}} \text{ cell} = \text{blanking} + (n \times \text{cell size})$$

Taking the figures above as an example, the blanking distance here is 0.1 m and the cell size is 0.2 m. The center of the first cell ($n=1$) is located at $0.1 \text{ m} + 1 * 0.2 \text{ m} = 0.3 \text{ m}$ from the instrument. The measurement areas extend to twice the configured cell size and overlap; greater weighting is given to measurements from the center of the cells and they are consequently reported as discrete cells. Therefore, the full extent of the first cell is from 0.1 to 0.5 m. Correspondingly, the center of the second cell is $0.1 \text{ m} + 2 * 0.2 \text{ m} = 0.5 \text{ m}$ and the full extent of the cell is from 0.3 to 0.7 m. In the data, these will be reported as 0.2 to 0.4 m and 0.4 to 0.6 m respectively.

Note that these numbers are projections along the vertical axis; the numbers along the beam axis are larger by a factor of $1/\cos(25)$ due to the transducer geometry. The total range of the measurement area is determined by the acoustic frequency and the [scattering](#) return from the water.

2.1.6.3 Summary

Instrument	Frequency	Min. Blanking	Max. # Cells	Cell size	Profiling Range
Aquadopp	2 MHz	0.35 m	1	0.75 m	-

Aquadopp DW	2 MHz	0.5 m	1	0.75 m	-
AquaPro	400 kHz	1 m	96	1-8 m	60-90 m
	600 kHz	0.5 m	96	1-4 m	30-40 m
	1 MHz	0.20 m	96	0.3-4 m	12-20 m
	2 MHz	0.05 m	96	0.1-2 m	4-10 m
AWAC	400 kHz	1 m	128	1-8 m	100 m
	600 kHz	0.5 m	128	0.5-8 m	50 m
	1 MHz	0.4 m	128	0.25-4 m	30 m
Continental	190 kHz	2 m	128	2-20 m	200 m
	470 kHz	1 m	128	1-10 m	100 m

Table: Overview of the instrument's default blanking distances, maximum number of cells, cell sizes and ranges. Note that these limits can be found in the instrument specific brochures too, and they are added in the software.

2.1.7 Orientation

2.1.7.1 Pitch, Roll and Heading

In their raw format, currents are measured along each of the three beams. In order to get the information referenced to earth coordinates (ENU) it is therefore necessary to detect the instrument's orientation in space. Attitude sensors, such as pitch, roll and compass heading are therefore used to aid in the transformation needed to correct for the instrument's attitude and motion.

When the instrument is tilted during deployment, the measurement cell from e.g. beam 1 does not correspond to the same measurement cell of e.g. beam 2, as illustrated below. In this example, depth cell 6 from the first beam corresponds to depth cell 7 of the second beam when the instrument is tilted 15°. In all current profilers, the velocity is measured in fixed cells along each acoustic beam. The length of each cell ("cell size") is defined as a time interval multiplied by the speed of sound, which is then projected onto the vertical axis. However, since the beam axis is not vertical (but 25°), the size of the cell will not be the same in beam 1 as beam 2 when tilted.

Note that the transforms from beam or XYZ to ENU (see [Coordinate System](#)) correct for tilt (and compass) in the sense that the final coordinate system is aligned with the gravitational axis (and the magnetic north pole). However, the data are not automatically corrected for the vertical mapping of the cells (use cells at the same level) and for this reason, there will be residual errors in the current profile. The residual error can be characterized by:

- Smearing of shear: the shear layer will look thicker than it really is, since the measurements are retrieved at different depths.
- Apparent vertical velocities: in areas of shear, there will appear to be a vertical velocity that is in fact an artifact of the processing.

It is possible to remap the velocity cells for each beam and thereby minimize the residual error. This is not done in the instruments for the simple reason that the mapping is non-linear. Remapping is included as processing options in the Storm and Surge software packages. Depth cell mapping matches the cells at equal depth by using the information from the tilt sensor when computing the velocity, to maintain the assumption of horizontal homogeneity of the current velocity. Reprocessing with the software will also ensure that the shear data are as accurate as possible. The best solution, however, is to make sure the instrument is level during deployment. Tilt degrades data in ways that are not always recoverable, such

as increasing the thickness of the surface sidelobe layer and in some case reducing the effective range of your instrument.

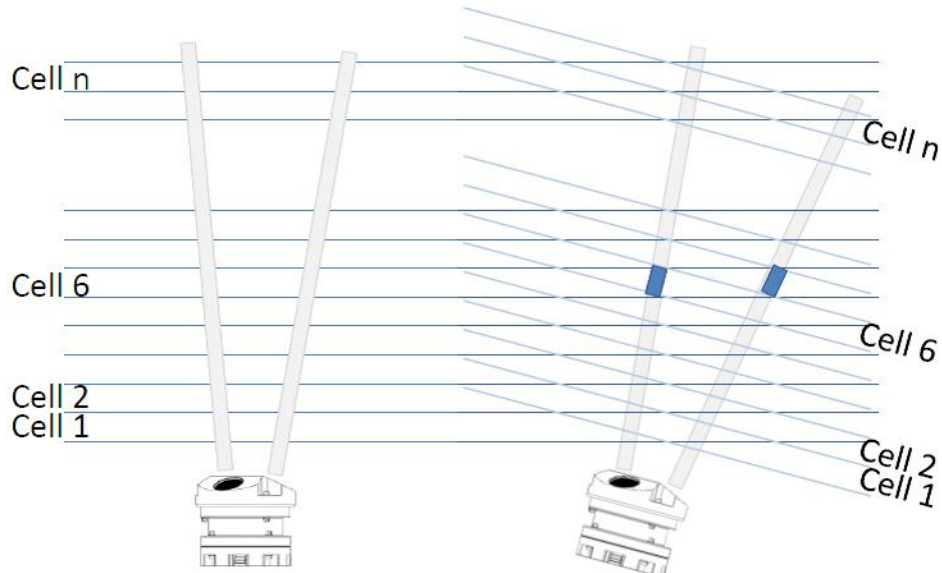

Tilting of the instrument (here 15°) result in measurements from different cells at the same depth.

Sometimes deployment frames tilt excessively or even fall over. If the instrument's tilt reading is 20° or less, your data should be within the specifications. Tilt readings between 20° and 30° affect the data accuracy in a way that is likely to make the data fail to meet the specifications. Data acquired during tilts exceeding 30° are in general not reliable and should be discarded. Using an AWAC with the AST option, a maximum tilt of 5° within the vertical should be targeted, although tilts up to 10° may yield acceptable if less accurate data.

2.1.7.2 Coordinate System

You may specify the preferred coordinate system in the Deployment Planning menu. The velocity measurement is a vector in the direction of the transducer beam, which we refer to as beam coordinates. Beam coordinates can be converted to a Cartesian coordinate system (XYZ) by knowing the beam orientation. Furthermore, the flow can be presented in Earth normal coordinates (ENU: East, North and Up) if the instrument is equipped with a compass and tilt sensor. ENU and XYZ coordinates are the most practical when handling data. Beam coordinates are primarily useful for higher-level turbulence calculations and for dealing with phase ping issues.

The coordinate systems are defined as follows:

- In Beam coordinates, a positive velocity is directed in the same direction as the beam points. Beam 1 is marked with an "X" on the head.
- In XYZ coordinates, a positive velocity in the X-direction goes in the direction of the X-axis arrow. The X-axis points in the same direction as beam 1. Use the right-hand-rule to remember the notation conventions for vectors. Use the first (index) finger to point in the direction of positive X-axis and the second (middle) finger to point in the direction of positive Y. The positive Z-axis will then be in the direction that the thumb points. Remember that XYZ coordinates are relative to the probe/instrument head and independent of whether the instrument points up or down. When you collect data in XYZ

coordinates Y is reported as a direction of 0° and X is reported as 90°; this is based on the instrument's coordinate system, and is not related to the magnetic heading.

- In ENU coordinates, a positive east velocity goes toward east. This is also a right-handed orthogonal system. When you collect data in ENU coordinates N is reported as 0° and E is reported as 90°. North is Magnetic North.

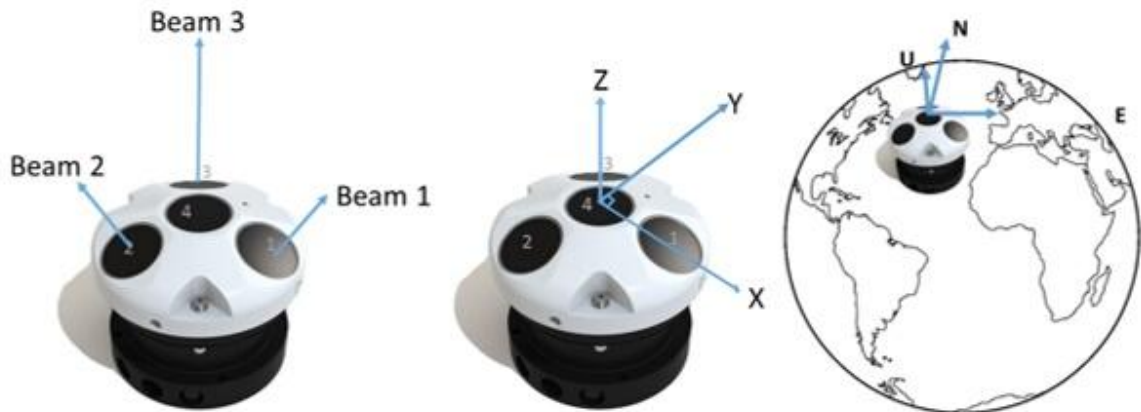

Figure: Coordinate systems. From left: Beam coordinates, XYZ coordinates and ENU coordinates

The figure below shows how the XYZ coordinate system works on different instruments.



Figure: The AWAC and Aquadopp (symmetric head) XYZ coordinate systems and beam numbering as defined relative to the beams. Beam 1 point in the direction of positive X-axis; beam 1 of the AWAC and Aquadopp is marked with an X engraved on the housing.

For the interested reader: one may notice that the X component is predominantly measured by beam 1 with nearly equal contributions from beam 2 and beam 3. This makes sense since the XYZ coordinate system is aligned with X pointing along one beam. Beams 2 and 3 are at some angle α to the X-axis and measure a component of X proportional to $\cos(\alpha)$. For the Y-component, beam 1 contributes to zero (or very near zero) because the Y-component is perpendicular to beam 1. Finally, the Z component is an equal combination of all three beams since each beam is at the same angle to the Z-axis.

To calculate speed and direction from velocities in an orthogonal coordinate system, you can use the following equations (X can replace East, and Y can replace North):

Current speed (Pythagoras): $\sqrt{East^2 + North^2}$

- Excel and Matlab: `sqrt(East^2+North^2)`

Current direction: The calculation is based on the familiar $\theta = \arctan(X/Y)$. In order to know the correct quadrant that the computed angle belong in, one has to use the four-quadrant inverse tangent, `atan2`. The $180/\pi$ converts from radians to degrees. The modulo (`mod`) is taken in order to avoid negative degrees. Note that the X,Y convention is reversed for Excel vs Matlab.

- Excel: `MOD(ARCTAN2(East,North)*180/PI,360)`,
- Matlab: `mod(atan2(North,East)*180/pi,360)`

Note that the current direction is defined as **towards**.

2.1.8 Operational Considerations

2.1.8.1 Sampling Strategies

It is recommended to use the Help file that is available within the instrument software for a complete overview of each of the setup parameters available. In this overview, averaging interval, profiling interval (also called measurement interval for the non-profiling instruments), burst interval and sampling rate are covered. Some instruments also support continuous measurements, which means that the instrument is actively collecting data at all times until it is stopped.

For a typical stand-alone deployment, the instrument will be configured to sample for a certain period of time and then sleep between each measurement cycle in order to save power. Below is an example showing a typical stand-alone deployment:

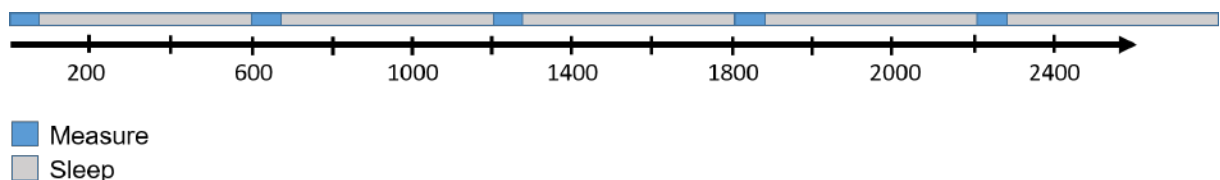

Figure: Sampling sequence when an instrument is configured with a Profiling interval/Measurement interval of 600 sec, and an Average interval of 60 sec.

During the measurement period, the velocities and pressure will be sampled each second (unless specified otherwise), and the same applies for temperature and tilt. Heading will be sampled at the specified "Compass Update" rate. The data will be output once the measurements are finished. A general rule when selecting an appropriate sampling strategy is to consider how often you need data and what type of variations you want to resolve. Read more about this in the [Mechanical and Processing Methods to Ensure Quality Profiles](#) section.

Note: Aquadopp current meters have the ability to sample at 4 Hz. Contact Nortek for more information. If 4 Hz sampling is enabled, PUV wave data cannot be collected.

For a Burst measurement sequence, the instrument will sample rapidly for a set period of time. A general rule to figure out the maximum sampling rate for a certain configuration is to consider what information you want to resolve. For example, to measure turbulence and get appropriate turbulence statistics requires accurate velocity time series that are measured fast enough and at a spatial scale that is appropriate to the flow. The ping rate is fixed according to the acoustic frequency and velocity range.

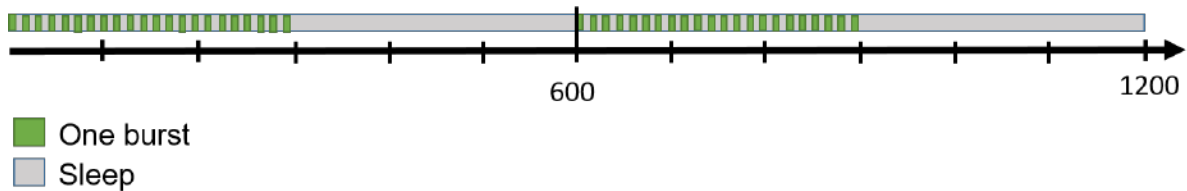

Figure: Sampling sequence when an instrument is configured for Burst sampling, with 600 sec burst interval, 300 samples at 1 Hz

2.1.8.2 Modes of Operation

The operational modes for any Nortek system are:

- **Command Mode:** an instrument in Command Mode is powered up and ready to accept your instructions. If no commands are received for about five minutes, it automatically goes into Power Down Mode.
- **Power Down Mode:** the Power Down Mode saves power during deployments and prevents your battery from discharging between deployments. The instrument automatically powers down from Command Mode after about five minutes of inactivity.
- **Data Acquisition Mode:** the instruments enter Data Acquisition Mode when you click any of the Start commands (e.g. Start Recorder Deployment) in the software.

This information is of particular interest if a direct command interface is desired. The [System Integrators Guide](#) is a manual that will come in handy for this type of use.

2.1.8.3 Velocity Uncertainty

The Doppler velocity uncertainties comprise two types of errors; the short-term error (random) and the long-term error (bias).

The velocity measurements are the average of many velocity estimates (called pings). The uncertainty of each ping is dominated by the short-term error. This error is uncorrelated from ping to ping, so by averaging together many pings, the measurement uncertainty is reduced. The short-term error depends partly on internal factors, such as the size of the transmit pulse, the measurement volume, and the beam geometry. Beams parallel to the dominant flow will have smaller short-term errors than beams at a steep angle relative to the flow.

The instrument's software predicts errors based on the short-term error of a single ping and the number of pings averaged together. Averaging multiple pings reduces uncertainty according to the formula:

$$\sigma_{mean} = \frac{\sigma_{single\ ping}}{\sqrt{N}}$$

Where σ represents the standard deviation and N is the number of pings you average together. Note that the software predicts only the instrumental error.

In many situations, external factors such as the environment itself dominate the short-term error. This is true near an energetic surface and in turbulent flows such as boundary layers and rivers. In situations like this, your data collection strategy should take into account the nature and the time scales of the fluctuations. Here are two examples:

- Waves: when measuring mean velocities in the presence of waves you should sample velocity at roughly $\frac{1}{4}$ the interval of the dominant wave period, and you should sample through 6-10 wave cycles.
- Turbulent flow: in boundary layers, a rough rule of thumb is that the RMS turbulent velocity is 10% of the mean velocity. If, for example, your mean velocity is 1 m/s, you could estimate turbulent fluctuations to be 10 cm/s. Obtaining 1 cm/s RMS uncertainty would require at least 100 pings.

When averaging several pings to reduce the error, there is a difference between the resulting “mean current” and the measured current. This deviation from the actual current measurement is called bias. The bias is often much smaller than the random errors you remove by averaging, and it represents the limit to how much you can reduce your short-term error. The long-term bias depends on internal signal processing, especially filters, and by the beam geometry. The long-term bias for the Aquadopp is typically less than 1 cm/s.

Horizontal and Vertical Velocity Precision

Horizontal and vertical velocity precision is presented in the Deployment Planning menu in the relevant software. The value given is a theoretical estimate of the precision of the velocity measurements based on how the instrument is set up. The velocity precision is always calculated along beam first and is a function of frequency, bandwidth, cell size and velocity range. From there the horizontal and vertical precision is calculated based on number of beams and the geometry of the head. The nominal value is given for the horizontal components in a default instrument acoustic beam configuration. In order to improve the precision the user may consider one of the following options: (1) larger cell sizes, or (2) longer average interval (see advanced menu settings).

- Standard deviation (precision) of the velocity measurements is inversely proportional to the depth cell size (larger depth cells give smaller standard deviations).
- Doppler-based current measurements are a statistical process where you need a certain number of measurements to average over, in order to get a stable value. Decreasing the averaging time thus increases the uncertainty in your measurements.

NB: For a 2D-AWAC with only two beams, you can calculate the horizontal velocity precision by multiplying the reported vertical velocity precision by $\sqrt{3/2}=1.22$.

Averaging

When you average a collection of velocity measurements, your average is a better estimate of the true velocity than each individual estimate. The uncertainty of the average is reduced according to:

$$variance_{mean} = \frac{variance_{individual\ measurements}}{N}$$

In other words, if you reduce the variance of individual measurements by a factor of 2, you can collect data twice as fast.

Measurement Load

By increasing the measurement load, the precision in the velocity measurements increases, but at the expense of battery consumption. By decreasing the measurement load you worsen your precision but save more power. The exact relationship is shown in the Advanced tab in the Deployment planning menu. Vary the measurement load, click on Apply, and watch the change in the battery utilization (for a specified assumed measurement duration) and the velocity precision. As you will see this is a trade-off between need for precision and need for duration.

A 100% measurement load means that the instrument pings as fast as it is able to (the maximum internal sampling/ping rate). Consequently, a measurement load of 50% means that the instrument pings at half that rate. From signal theory we know that the more pings there are within an averaging period, the better the estimate of the true value we are measuring will get. A high ping rate will thus reduce the standard deviation (which is called "precision" in the Deployment Planning menu).

To illustrate what we are talking about, consider the below list which provides the maximum internal sampling rate of some of our instruments:

Aquadopp	Aquadopp Profiler	AWAC
23 Hz	2 MHz: 23 Hz	1 MHz: 7 Hz
	1 MHz: 7 Hz	0.6 MHz: 4Hz
	0.6 MHz: 4Hz	0.4 MHz: 2Hz
	0.4MHz: 3Hz	

2.1.8.4 Maximum Range and Signal Strength

The profiling range and spatial resolution is primarily a function of the acoustic frequency. Instruments using a low frequency have longer range than instruments using higher frequency; on the other hand, the latter has better spatial resolution. The maximum ranges published for all acoustic Doppler profilers refers to a nominal value, with the possibility that the actual values obtained could be longer or shorter than the desired range. This is something that impacts any type of acoustic instrument from any type of manufacturer. The profiling range is also dependent on the scattering conditions and the cell size. The latter because of the amount of energy transmitted into the water is set according to the cell size. The concentration of scattering materials and the strength of the scattering return from the water will influence the profiling range; more particles reflect more sound. The amount of particles in the water varies with depth, a subject that is covered in the next section.

Signal strength (amplitude) is a measure of the magnitude of the acoustic reflection from the water, and is a function of type and amount of particles in the water. Due to spreading and absorption, the signal strength decreases with range. The signal strength is accessed as raw signal amplitude (using dimensionless units called [Counts](#)) or as a Signal-to-Noise ratio (SNR, in dB). The determination of the range over which the instrument can measure velocity accurately is the primary use of the signal strength. It may also be used to retrieve information about the suspended sediment or the concentration of the scattering materials. Note that this is usually not recommended because different types of scattering elements produce different echoes, and it is difficult to distinguish between conditions with few, relatively big scattering elements or many small elements.

When the signal strength reaches the noise level, the maximum range is reached. The Doppler Shift is not accurately measured beyond this point. The noise floor is typically found at around 25 counts (as displayed in the figure below), but the noise floor for your specific instrument can also be found by running a couple of measurements in air.

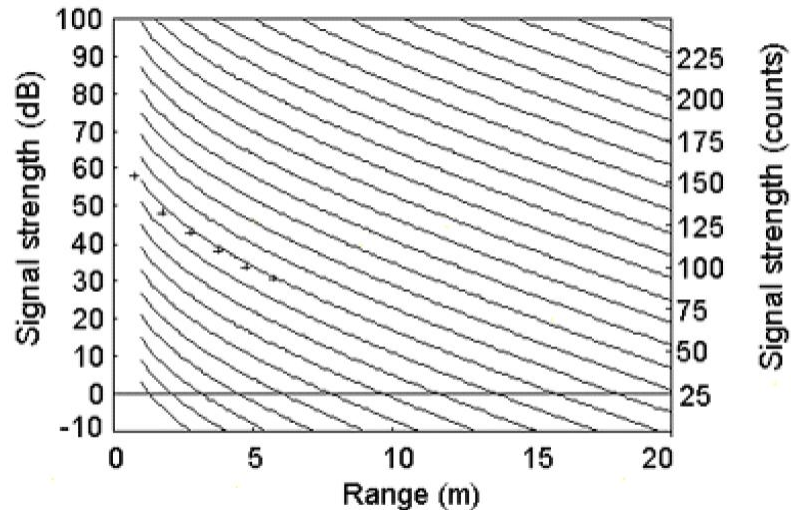

Figure: Measurement range vs signal strength at 2 MHz.

The figure above shows how signal strength varies with range, based on the Sonar Equation. The family of curves represent different source levels. The Sonar Equation accounts for the frequency of the transducers, sound spreading and reduction in signal strength as the sound pulse travels and reaches the particle, the amount of sound reflected back to the transducer and sound spreading and reduction in signal strength as the reflected pulse travels back.

2.1.8.5 Ocean Scattering

The instruments rely on acoustic backscattering to operate. The amount of energy that comes back from the water depends on the number of particles that are suspended in the water column. Very clean water means few particles and it is thus a poor scattering environment. Velocity estimates have greater uncertainty when the received acoustic signal is very weak. To overcome weak acoustic echo an increase in the transmit power may be the solution, but this also increases the power consumption. Some background knowledge about the scattering conditions at the area of measurements is helpful. The water column in the open ocean can be divided into four zones when discussing acoustic scattering:

- The upper 100 m: light penetrates and this zone is characterized by high biological activity. The acoustic scattering is strong and getting adequate SNR is normally not an issue. In this zone, the instruments can be operated with reduced transmit power to save power.
- The bottom 100 m: fine sediments are lifted into suspension by turbulence generated as the water flows over the bottom. In this zone, the SNR is adequate and a profiling instrument has a useful range. In terms of instrument design, this is an “easy” part of the water column, even if the bottom is located 6000 m below the surface.
- From the surface to 1000 m: in this zone, there is a gradual decrease in the SNR as you move downwards. There is still biological activity and the SNR is generally adequate. There is a chance that the SNR may change with the seasons, so we generally recommend that instruments deployed in this zone are configured for maximum output power.

- From 1000 m below the surface to 100 m above the bottom: this is the most challenging area, characterized by minimal biological activity and very weak acoustic scattering. The Aquadopp DW should always be configured for maximum power output when deployed in this part of the water column.

There are also certain regions in the world where scattering conditions are less than optimal. These can vary with season.

- Extreme latitudes: these cold regions tend to be less supportive of biological activity (i.e., plankton) and therefore there is less scattering material in the water.
- Tropical regions: regions where there is clear visibility from the surface have reduced scattering.

2.1.8.6 Sidelobe Interference

As the [Measurement Area figure](#) illustrates, the water column can be divided into different regions. A current profiler has a couple of un-measurable areas in its profile; it cannot measure velocities in the area close to the sensor head, due to the described ringing and the required blanking distance (if you do not use a Z-cell instrument). In addition, it cannot measure the velocities close to the remote boundary, whether it is the seabed or the surface (depending on mounting location), due to an interference phenomenon known as sidelobe interference. Data collected by an Aquadopp can also be restricted by this interference.

Data from the upper region of the water column may be influenced by sidelobe interference. The acoustic beams focus most of the energy in the center of the beams, but a small amount leaks out in other directions. Because sound reflects much stronger from the surface / air boundary than from the water, low energy signals that travel straight to the surface can produce sufficient echo to contaminate the desired signal from the water. This type of interference may affect 5-10% of the velocity profile. As sketched in the figure below, the Sidelobe energy will reflect from the boundary while the main beam is still in the region near the boundary. If the distance to the surface is A (see figure below), then contamination of the current measurements begins at the same distance A along the slanted beams. In the figure, the top two cells might be contaminated. The following is an approximate equation illustrating the constraint of near-surface contamination:

$$R_{max} = A \cos \theta - \text{cell size}$$

Here, R_{max} is the range for valid data and θ is the angle of the beam relative to vertical. The take home is to be cautious in the upper part of the water column. A tip when analyzing data is to check the vertical velocity (Z) extra carefully in this area. It should read ~ 0 m/s. If not, it might be an effect of interference.

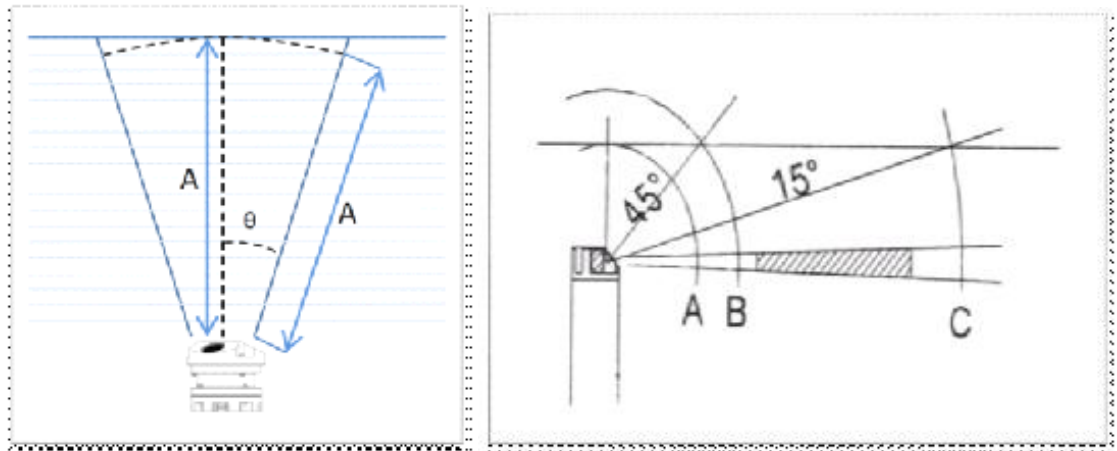

Figure: The geometry of sidelobe interference. Left: a profiler; here an AWAC. The upper two cells are contaminated by interference. A is the vertical distance to the surface, θ is the angle of the beam. Right: Aquadopp with definitions of three positions along the beam; A is where the distance along the beam equals the distance straight up to the surface, B is the distance along the beam equal to the distance to the surface along a 45° angle, C is the distance along the beam equal to the distance to the surface along a 15° angle. The shaded area is the proposed measurement area.

The extent to which the sidelobe interference will contaminate the velocity measurements is a function of the boundary conditions, the scattering return strength from the water and the acoustic properties of the transducers. Because the instrument's beams are narrow, sidelobe interference is not always a factor in the measurements. It may be unimportant in water with strong backscatter (i.e. sediment-laden estuary), but may contaminate when the backscatter is weak.

If you are concerned with sidelobe interference, the Figure B above illustrates how to minimize the possibility of contamination in your data, when you are near the water surface using an Aquadopp with the sketched head configuration. Sidelobes returning vertically from a smooth water surface (Position A in Figure B) pose the most likely source of contamination. Even though sidelobe interference from this direction is very weak, a smooth water surface is the strongest reflector you will encounter - it behaves like a mirror. As the angle increases (toward Position B), the strength of the surface echo weakens substantially. From Position C and beyond, the angle between the surface and beam become disadvantageous again, the sidelobe interference begins to increase and your beam may begin to be affected by surface velocities. This may not be such a problem because the surface velocity is typically close to the velocity just below the surface.

The situation changes if you place the Aquadopp near the bottom (turn Figure B upside down). Echoes vertically from the bottom are typically much weaker than the mirror reflection from the surface, so contamination at Position A will be less serious. However, contamination at Position C could be more serious; the bottom does not move, and the backscatter from hard reflectors like rocks can be large.

2.1.8.7 Speed of Sound

As already elucidated, the speed of sound in water influences the calculation of the velocity data. The time lag between the transmitted and received pulse determines how far the pulse traveled before it was reflected.

Speed of sound increases with increased temperature, salinity and pressure. The instruments compute the speed of sound based on the measured temperature (accuracy of 0.1°C). A nominal salinity is assumed, an assumption that works relatively well because the sound speed is more sensitive to temperature variation than it is to salinity variation.

- A variation of 1°C translates to approximately 4.5 m/s in speed of sound variation.
- The average salinity of sea water is around 35 psu. The rate of variation of sound velocity is approximately 1.2 m/s for a 1 psu alteration in salinity.
- Pressure is a function of depth and the rate of change of sound velocity is approximately 1.6 m/s for every alteration of 10 atm, i.e. approximately 100 meters of water depth (derived by the hydrostatic equation). This is not compensated for by the instrument.

The estimates of the horizontal velocities will not be affected by variations of speed of sound. The interested reader can check out the theory behind Snell's law, but the concept is that the acoustic energy travels the same path from the transducer to the particles and back again, and is therefore negated. Because the instrument measures the change in frequency (and not time or distance), the instrument only needs to know the sound speed at the location of the instrument.

On the other hand, the range accuracy is dependent on the sound speed profile. That means that the position of the measurement cells in the water column will change if the speed of sound profile changes. The only way to know for sure the vertical position of the measurement cells is then to use a Sound Velocity Profiler or a CTD to measure the sound velocity profile through the water column.

When estimating the distance to the surface using the vertical altimeter (for wave measurements), the two-way travel time of the short pulse transmitted towards the surface is used together with an estimate of the speed of sound. Deviations between the true speed of sound profile and the estimated profile (here assumed to be uniform with depth) will directly lead to errors in the distance to the surface. The estimated profile is based on a fixed salinity and the measured temperature. These deviations can lead to absolute distance errors of up to 3%, but are typically much less. This presents more of an error for absolute distances than relative distances (such as wave height). The same error applies to surface displacements, where 3% is an acceptable error for wave height.

Sound speed errors are typically small, but if you must correct velocity data for errors, use the following equation:

$$V_{corrected} = V_{old} \left(\frac{C_{new}}{C_{old}} \right)$$

Here, V is the velocity and C is the speed of sound.

2.1.8.8 Practical Considerations for HR AquaPro

The following paragraphs are also outlined in the AquaPro HR software Help guide (accessible from the Deployment Planning pane), but are repeated here due to their importance. The principles of pulse coherent profilers can be found in [Principles of Operation, Part 1](#).

The first step of data collection, transmitting an acoustic pulse and recording the echo, is normally a trouble-free process. The second pulse is transmitted only a short time after the first one (of order ms)

and recording the echo from the second pulse is the critical process in any HR system. If the echo from the first pulse, for any reason, overpowers the echo from the second pulse, we have a situation commonly referred to as "pulse-to-pulse interference". Avoiding this type of situation is one of the main difficulties in properly configuring a HR profiler and the user is normally forced to make several trade-offs.

HR Aquadopp Profiler deployment planning involves balancing multiple factors when setting up the profile parameters. The depth cell size, profile length, pulse distance, sample rate, and distance to a boundary (if applicable) will all need to be considered to achieve the highest quality data for a given deployment. It is recommended to read the technical note named [A Practical Primer for Pulse Coherent Instruments](#) for a thorough review of the subject.

To assist in configuring the HR profiler, the standard software menu encourages the user to choose between three common mounting scenarios. The software will then automatically select some of the configuration parameters in what we believe is the best possible way. If none of these scenarios properly describes the measurement situation, the user must manually configure the profiler using the advanced menu. The standard scenarios are:

1) System oriented downward and mounted at a known distance above the bottom.

If practical, this is normally the easiest way to get good data from a HR profiler. The software will use the distance entered as the key parameter and the spacing between the acoustic pulses is set to be slightly larger than the distance to the bottom. Because the strong bottom echo from the first pulse reaches the transducer right after the second pulse is transmitted, the acoustic interference does not affect the velocity close to the bottom. In addition, if the bottom consists of mud, silt or sand, the first pulse will often die out once it hits the bottom. As a result, there is no pulse-to-pulse interference. If the bottom is made of strong acoustic reflectors such as rocks, coral reefs, etc., the first pulse will generally not die out and some level of interference should be expected.

Note that if the distance to the bottom is set to be smaller than what it actually is during the deployment, the second pulse will be transmitted too early. As a consequence, the profiler will not collect data close to the bottom. If the distance to the bottom is set to be larger than what it actually is during the deployment, the second pulse will be transmitted too late. The consequence is that data will be lost in a band close to the instrument. Normally, the data close to the bottom is more important than the data close to the profiler so if the distance is not precisely known, it is better to fail on the side of overestimating the distance to the bottom.

2) System oriented toward the surface, deep water.

A practical approach to the meaning of “deep water” is a little more than twice the desired profiling range. If you choose this configuration, the distance between the pulses is set to be a little more than the requested profiling range. In this situation, pulse interference is rarely a problem. The exception is the cases where strong acoustic scatters congregate just beyond the profiling range. For example, a fish swimming 1.5 m above the bottom could give interference in the velocity profile if the profiling range is set to 1 m. The interference will show up as an outlier in the data collected at a range of 0.5 m (roughly). Since the amplitude data for the HR system is normally recorded while registering the echo from pulse number one, the source of the interference cannot easily be identified.

3) System oriented toward the surface, shallow water.

Shallow water does in this case mean that we have to worry about acoustic interference from the surface echo. Intuitively it may seem that this situation is similar to the downward looking profiler (close to the bottom) but two phenomena make the surface acoustically different from the bottom:

- The echo does not die out when it hits the surface.
- The position of the surface can vary over time (tides or waves).

The software’s deployment planning menu takes a conservative approach to this situation and sets the profiling range to be a little less than half the distance from the instrument to the surface. This ensures that it is possible to listen to the echo from both pulses without interference. However, it is only possible to measure the lower part of the water column and data will be lost toward the end of the profile if there significant surface wave activity. A more aggressive approach in this situation would be to pretend that this case is similar to the situation where the profiler is mounted profiling downwards. However, this approach will give high quality data only when the surface is very smooth and the velocity profile measurements can break down completely if there is significant wave activity. Our recommendation is that alternative instrument configurations are considered only after experience has been gained about the exact situation at the deployment site (i.e. test deployments).

2.1.8.9 Data

Velocity

Velocity data is output in m/s. The preferred coordinate system may be specified to use for velocity data. The raw velocity measurement is a vector in the direction along each of the beams, which is referred to as beam coordinates. Beam coordinates can be converted to a Cartesian coordinate system (XYZ) by knowing the beam orientation. Furthermore, the flow can be presented in Earth normal coordinates (ENU: East, North and Up). In order to get the information referenced to earth coordinates (ENU) it is therefore necessary to detect the instrument's [orientation in space](#). Attitude sensors, such as magnetometer and tilt are therefore used to aid in the transformation needed to correct for the instrument's attitude and motion.

Amplitude

The instrument works by measuring the reflection of an acoustic signal from particulate matter in water. Amplitude, or signal strength, is the strength of the return signal for each beam and is output in counts. Amplitude decreases with distance from the instrument and also establishes the maximum useable range. Read more about amplitude and SNR limits in the [Maximum Range and Signal Strength](#) section.

Amplitude data may indicate spatial and temporal variation. An amplitude quality test should be applied to each beam, and to each cell. If the amplitude increases with distance in one or more beams it may indicate a solid boundary such as the bottom or an obstruction. Natural temporal variation can be explained by the diurnal vertical migration of plankton. If a bottom mounted instrument is completely covered by sediments then the amplitude data will reveal this indicating a rapid amplitude decrease with distance.

Correlation (relevant for AquaPro HR)

Correlation is a statistical measure of similar behavior between two observables, which in our case are the received signals with respect to time. Correlation is output in %, where 100% means perfect correlation and 0% means no similarity. The magnitude of the correlation is thus a quality measure of the velocity data, and as the correlation decreases so does the data accuracy. The correlation can provide a means for cleaning up data in QA/QC.

[Sensor](#) data is also output.

The raw and ASCII converted extensions are described in the figure below.

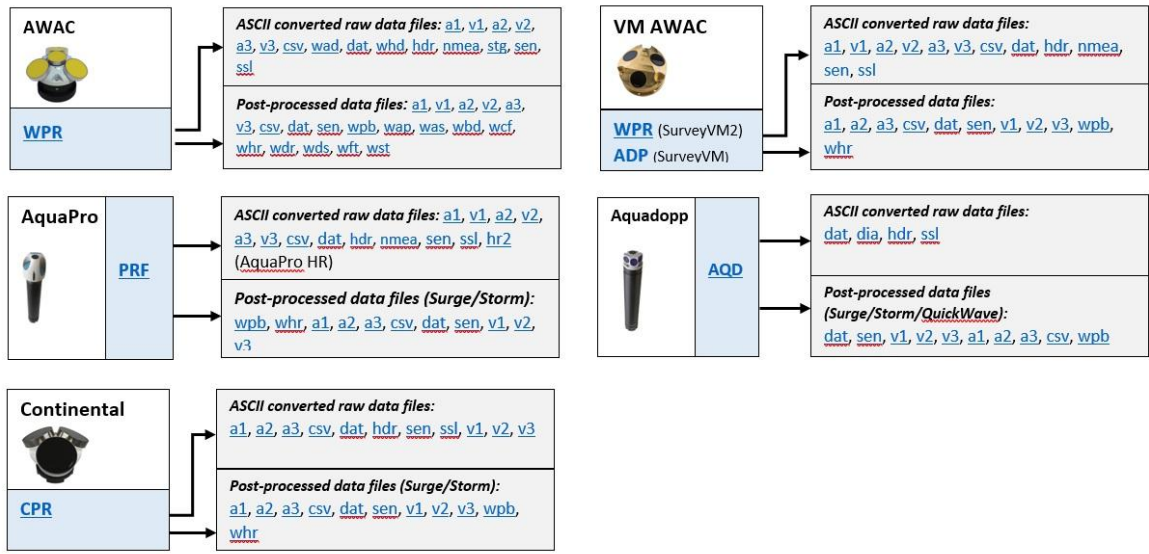

Data Formats

Raw binary data files:

ADP	VMCP (SurveyVM)
ADV	Vectrino, for processing in ExploreV. Accessible through the Data Conversion feature in the Vectrino software.
AQD	Aquadopp and Aquadopp DW
CPR	Continental
PRF	Aquadopp Profiler
WPR	AWAC, VMCP (SurveyVM2)

ASCII converted RAW data files:

(Use Data Conversion feature in the instrument deployment software. Format will be described in the generated .hdr file)

A1	Amplitude data (Beam 1)
A2	Amplitude data (Beam 2)
A3	Amplitude data (Beam 3)
CSV	Profile data (Comma Separated Values file)
DAT	Velocity data
DIA	Diagnostic data
HDR	Header file (describes ASCII formats)
HR2	Lag2 data (when Extended Velocity Range enabled)
NMEA	Raw data in NMEA format
PCK	Probe check data
SEN	Sensor data

SSL	System state file
STG	Stage data file (for diagnostic purposes)
V1	Velocity data (Beam 1/X/East)
V2	Velocity data (Beam 2/Y/North)
V3	Velocity data (Beam 3/Z/Up)
WAD	Raw wave data
WHD	Wave header data
CPA	Continental data, disk recording, ASCII output
PRA	AquaPro data, disk recording, ASCII output

Processed data files:

WAP	Wave parameters
WAS	Wave energy spectra
WBD	Wave band estimates
WCF	Wave Fourier coefficients
WDR	Wave directional spectra
WDS	Wave full directional spectra
WHR	Configuration header file
WPB	Processed binary data
WST	Wave time series (AST/pressure)
WFT	Wavector export (Waveforce Technologies Wavector software)
A1	_p appended. Amplitude data (Beam 1)
A2	_p appended. Amplitude data (Beam 2)
A3	_p appended. Amplitude data (Beam 3)
CSV	_p appended. Single-point or profile data (Comma Separated Values file)
DAT	_p appended. Velocity data
SEN	_p appended. Sensor data
V1	_p appended. Velocity data (Beam 1/X/East)
V2	_p appended. Velocity data (Beam 2/Y/North)
V3	_p appended. Velocity data (Beam 3/Z/Up)

Other:

BIN	Head configuration file or firmware file used for upgrades
DEP	Deployment configuration
GPS	GPS data, SurveyVM
GYR	Gyro data, SurveyVM
MAT	Matlab data file
NPW	Surge/Storm workspace file

RCF	Configuration data, SurveyVM
SVM	Configuration data, SurveyVM2
VES	Vessel navigation data, SurveyVM2
NC	Data processed through SeaReport

2.1.9 Mechanical and Processing Methods to Ensure Quality Profiles

2.1.9.1 Configuration

General recommendations:

- Choose a profiling interval that captures the expected variations. For example, a typical tidal cycle is well resolved with a profile measured once every 5, 10, 20, or even 30 minutes.
- The cell size has a default setting that corresponds to the instrument's transmit frequency. This may certainly be changed, but be aware that smaller cells increases the measurement uncertainty, while large cells reduce the measurement uncertainty. Note that when doubling the cell size, you also double the power consumption. This is because the transmit pulse length is equal to the cell size, so you inject more energy into the water. Doubling the cell size therefore also adds 10% to the profiling range.
- The number of cells should be selected so that the profile extends a few cells beyond the bottom or surface boundary. This improves quality control of the data during processing.
- Typical moorings allow the instrument to tilt and rotate freely. It measures tilt and heading and uses this compass information to convert the data to true Earth coordinates. How often the instrument reads the tilt and heading depends on the deployment method used. Buoy mounted profilers should have the compass set to update relatively fast (every second) so that buoy motion is accounted for in the velocity estimates. For bottom-mounted instruments, it is enough with one compass update per burst, while instruments mounted on a mooring line should update the compass every other second. The predefined setups in the deployment planning in our software provide a compass-reading frequency reflecting the application. Because the magnetometer uses energy, the instrument reads heading only as often as it needs to. This trade-off between power consumption and the need for accuracy is well taken care of in the predefined deployment setups. We therefore recommend that you stick to the predefined compass update rates (as they appear when you select a deployment environment) when creating your own deployment setup, unless you have good reasons for doing otherwise.
- If magnetic fields are present in your deployment location, consider collecting data in XYZ coordinates rather than relying on the magnetometer to rotate the results into ENU coordinates.
- Salinity should be adjusted in the advanced menu options if it is significantly different from the default value.
- The Average Interval (AI) is the period over which the instrument measures and averages before it reports. The default 60 seconds is adequate for almost all applications. Changing this to a longer or shorter period is a tradeoff between improved resolution and power savings respectively. In protected areas with 3-4 s waves, an AI of 60 s is fine. Along the coastline, with 10+ s waves, 60 s is not enough. If your average time is too short, short-term effects like surface waves could dominate the estimate of the mean currents. With an averaging interval of e.g. 2.5 minutes, all influence from

surface waves will normally be gone. The advantage of using a longer averaging interval and a lower measurement load is that you get better statistical averages.

- From signal theory we know that the more pings within an averaging period, the better the estimate of the true value we are measuring. A high ping rate will thus reduce the standard deviation (called Precision in the deployment planning menu).
- A 100% measurement load means that the instrument pings as fast as it is able to. Consequently, a measurement load of 50% means that the instrument pings at half that rate. By increasing the measurement load, the precision in the velocity measurements improves, but at the expense of battery consumption. By decreasing the measurement load, it is the other way around. The exact relationship is shown in the advanced tab in the deployment planning menu.
- When using an AWAC for currents and wave measurements, we cannot provide specific recommendations on sampling rate other than the general criteria that you need to sample at least twice as fast as your signal of interest in order to resolve it unambiguously (i.e. the Nyquist sampling criteria). Note that when specifying the measurement interval, one should take into consideration that both current and wave measurements are made in turn (or cycle). Therefore, there must be enough time to make a wave and current measurement for each interval. A warning message will appear if there is a conflict.
- It is important to adapt the wave interval to the wave periods that are dominating in the area of interest. Waves are random and therefore measuring waves requires sampling over a period of time that will best “capture” or represent the complete sea state. For long waves, it may be necessary to increase the overall sampling period in order to ensure a proper statistical presentation. As a rough rule of thumb we try to get 100 cycles of the longest wave we would expect; this means for instance that if we expect the longest wave period to be 10 seconds for a particular body of water, then 1000 seconds is the preferred sampling length.
- Make sure you are using the most recent software and firmware for your instrument. Visit [our software page](#) regularly for updates.
- If you are using the High Resolution (HR) Profiler, make sure to understand the limits of the ambiguity velocity and have an educated guess of the maximum velocities expected at your site. Read our document [The Aquadopp HR Profiler: Extended Velocity Range Mode](#) for more information.
- A useful parameter when planning a HR Aquadopp Profiler deployment is the velocity-range product. This is a number with dimensions of L^2/T (length squared over time). As a guideline when planning a deployment for the HR Aquadopp Profiler, this number should not exceed 0.5 m^2/s for the 2 MHz system, and 1.0 m^2/s for the 1 MHz system. If Extended Velocity Range (EVR – see the linked HR Profiler document above for more information) is used with a 2 MHz system, the product should not exceed 0.9 m^2/s . For example, if you require a profile range of 1.0 m, then the maximum horizontal current velocity should not exceed 0.5 m/s (velocity-range product = 0.5 m^2/s). This parameter is simply a way of encapsulating a few of the tradeoffs and primarily deals with the relationship between profile length, pulse distance, and the ambiguity velocity. By staying below this value, the instrument is far more likely to measure good quality data, but it is only a rule of thumb and not a guarantee.
- The HR Aquadopp Profiler can measure with a fast sample rate and large measurement cell size, or a slower sample rate and smaller measurement cell size, but not a fast sample rate and small

measurement cell size. Fast and slow are of course somewhat relative, but the smallest measurement cell size will not permit measuring at the highest sample rate and vice versa.

2.1.9.2 Deployment

- It is important to remember that any motion of the instrument can significantly alter the flow pattern and amplify the vortex-induced forces. A primary goal is thus to keep the instrument from moving.
- Self-disturbance of flow is a chief source of data contamination with traditional current meters. Flow disturbance affects your measurements by changing the flow and by making it non-uniform across the instrument beams. Significant errors can be generated when the sensor samples in its own turbulent wake. Thus, it is important to consider the effects large objects will have on the flow itself. A rough rule of thumb is that objects disturb the flow as far as 10 diameters away from the object. Flow disturbance is greatest directly downstream in the wake behind the object. If you use e.g. an Aquadopp attached directly to a rope or cable, you can position the center of the measurement cell further away from the instrument to avoid the problem of self-disturbance. For most mooring situations, you can easily move an Aquadopp's cells more than 10 times the dimension of either the Aquadopp or the mooring structure.
- Use extra attention to ensure that no part of the deployment comes in the way of the beams (mooring lines, docks, frame, etc.). Objects in the way of the beams will reduce the profiling range as well as corrupt the data for the cell location of where the object is located. When mounting the instrument near large obstructions (bridges, piers, walls, etc.), ensure that the acoustic beams do not “see” any obstructions. Objects interfering with the beams may violate your data.
- Usually we aim to classify the incident wave and current field, therefore it is critical that we deploy the instrument in a location that exposes it to an incident wave environment that is undisturbed by its surroundings. Some neighboring structures that influence the data collection could include piers, breakwaters, unusual changes in bathymetry, as well as rivers (or exposure to high currents). Such structures affect the local wave field by reflections, diffraction, refraction, evanescent modes, etc. For example, an instrument deployed in front of a breakwater would be exposed to the combined incident and reflected waves. The PUV approach does not have the ability to separate these two fields. Therefore close proximity to any of the above listed is discouraged, unless of course the objective of the data collection exercise is to measure the locally influenced wave environment at the particular location of deployment. The AWAC, on the other hand, can provide information both about the incident and reflected waves.
- The range limit is either limited by a) a boundary where any one of the beams intersects it, or b) where there is not enough return signal from the scatters in the water (too little signal-to-noise ratio, SNR). In case a) the range is limited to 90% of the distance to the boundary (e.g. 18 meters for a bottom mounted profiler at 20 meter depth). The limit for b) is much more dependent on the clarity of the water; the more scattering particles there are in the water, the better the return signal strength (SNR).
- Mounting on or near metal that influences the magnetic field should be avoided. If this cannot be avoided then the user can either account for the effects (see [Compass Calibration](#) in the Service Manual), or note the orientation of the profiler in its deployment position (profiler heading) so that it may be corrected during data processing. The data can also be collected in XYZ coordinates instead of relying on the magnetometer. By using XYZ coordinates, the data will not be transformed to ENU coordinates, and are thus not at risk of being incorrectly transformed.

- If you are using an AWAC with AST it is important the bottom frame does not tilt too much (<5 degrees). Excessive tilt will reduce the quality of the vertical beam measurements. If possible, check the frame with a diver / camera after deployment to assure proper orientation.
- The deployment might move into a different measurement site if care is not taken. The shifting tide combined with a slack mooring line might result in data collection in different locations. It is important to consider stretching of the mooring components under tension, especially the mooring line, in order to know the exact horizontal and vertical position of the instrument.
- The depth should not exceed the depth limitations of the instrument's pressure sensor. The pressure sensor can physically handle pressure up to twice its stated limit, but will not record meaningful data. For example, the standard 50 m pressure sensor can safely withstand 100 m depth, but beyond 50 m the data will be unusable. Beyond 100 m the sensor will be damaged.
- Boundaries are not a concern in mid waters, but if you want to use the instrument near the bottom or surface, you should consider the boundaries as you design your experiment due to the risk of sidelobe interference.
- If the batteries need to be changed or the data need to be downloaded on a regular basis, the deployment should facilitate easy recovery and redeployment.

2.1.9.3 Data Processing

Since there are numerous possibilities for things that can go wrong during a deployment, we need to use all the information we have to qualify if data is good or bad. Bad data should be discarded or flagged. Many of the steps below are performed in the processing of the Storm and Surge software.

- The first step is to make sure that the instrument was oriented as intended. This is done by checking the time history of the tilt (pitch and roll) and heading sensor data.
 - If the tilt is large (greater than 10 degrees) then a post-processing option such as “map to vertical” is encouraged.
 - If the tilt is excessive (greater than 30 degrees), it may indicate current profiles are suspect to error.
 - If the tilt or heading measurements change greatly from profile to profile (buoy mounted), it is wise to ensure the instrument was configured as a buoy mount or with a suitable compass update rate (check the deployment file or the header file).
- The next step is to check that the pressure sensor is reasonable. In case of a sudden change in pressure or pressure reading indicating shallower water depth than expected, extra attention should be used. These events usually occur during the deployment, retrieval, and the occasional curious mariner. Data collected during these events should be avoided in the post processing.
- Perhaps the most important parameter to check for is the signal level for each of the individual beams for the full measurement profile. The typical behavior of the signal strength profile is that it starts high and exponentially decreases with distance from the instrument. At some point it either significantly increases because the transmit pulse has met a boundary (surface or bottom), or the signal no longer decreases and becomes constant. The cells where the signal begins to increase are likely to be corrupted by interference with a boundary, and should be removed from the profile. The constant signal level indicates the “noise floor”; as long as the signal level is above the noise floor, the measurement in the associated cell is valid. Cells in a beam that have signal level near the noise floor are not valid;

usually any current measurements beyond this range are erroneous and invalid. See the Troubleshooting Guide for examples.

- It does occur that just one beam is bad (signal near the noise floor in all cells), but in this case the data are still usable. One has to process the data with the two other beams (perform a two-beam calculation to retrieve 2D currents). Note that the processing makes one important assumption; the vertical currents are zero. This is a reasonable assumption in the vast majority of current flow.
- Current profiles that show large current variations vertically or vertical structures should be flagged suspicious. The ones that are most doubtful are those that are physically unrealistic (e.g. 1 m/s changes over a few meters). The measurements in a profile that are far from the mean are best removed.
- Raw wave data: the raw pressure signals give an immediate indication about the wave condition; long waves ($T > 8$ s) give a strong pressure signal at the bottom and a variation of 1 m in the pressure signal mean that the wave height is at least the same. On the other hand, a very weak signal in the pressure sensor (variations of only a few cm) usually means that the waves are small. The raw wave velocities will appear noisy even at moderate sea states. Only at times with large waves can you expect a smooth signal. Even so, the noise should not be excessive and it should be possible to see the wave signal when there is significant wave action on the surface. Watch out for large jumps or discontinuities; this could mean that part of the sampling volume has touched the surface, which would render the velocity data invalid. In the raw AST signal you should look for appearance, i.e. that the data look reasonable and that you have no data loss, and above all, that the data is similar to the pressure measurements.
- The AST distance data is not tilt corrected. The error will be $1/\cos(\text{tilt})$. Since maximum tilt is about 10 degrees, this is at maximum 1.5% of the total distance. This, combined with the fact that the wave estimates are based on changes in the distance to the surface rather than absolute distance, makes this negligible.

2.2 Waves

All bodies of water experience waves. These may range from long waves, such as tidal waves (caused by the gravitational forcing of the sun and the moon) to short waves generated by the wind's drag on the water surface. If you were to look at the distribution of energy for waves, you would see considerable variability ranging from 12 hours to 0.5 seconds. A significant contribution of this energy is found in the band from 0.5 to 30 seconds and is commonly referred to as wind waves (see figure below). Engineers and scientists are primarily interested in these waves. To measure these waves accurately it often comes down to how well this band is represented by the measurement method.

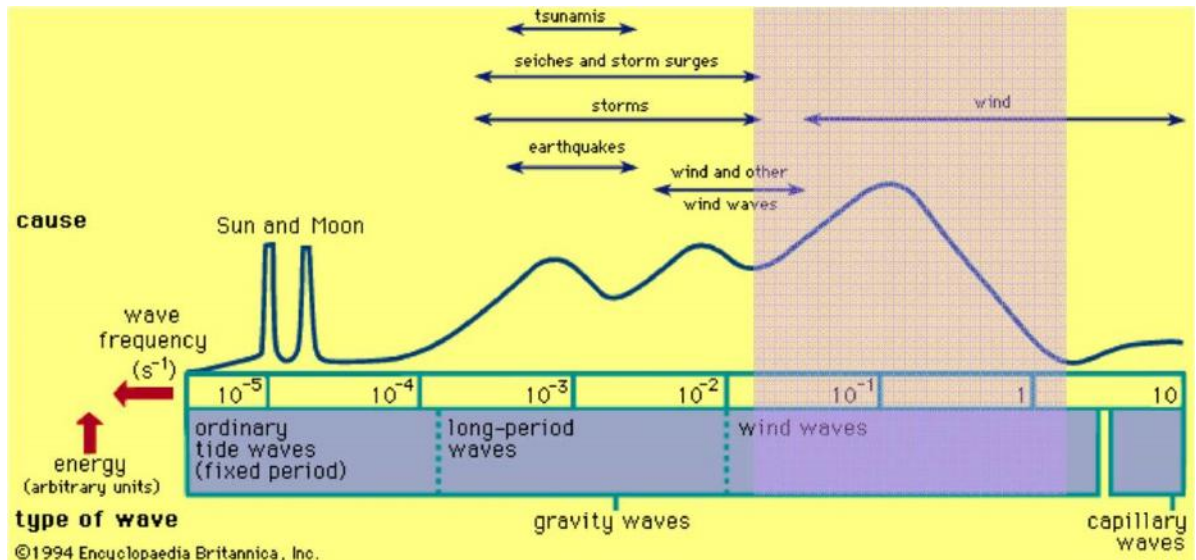

Figure: Distribution of energy. The region with periods from 0.5-30 seconds represents the wind wave band portion of the spectrum. Remember that $\text{Period} = 1/\text{Frequency}$.

Wind waves have a variability that makes characterizing waves non-trivial. Waves begin both small in height and short in length, created by local winds and grow as a function of wind strength, duration of wind, and distance. As a result, the wave environment at a particular location may be composed of a combination of local wind waves from a sea breeze and long waves (swell) generated by storm events hundreds or thousands of kilometers away. What this means to someone trying to measure waves is that they need to appreciate the fact that the local sea state is composed of waves with different amplitudes, periods, and directions. Understanding this is the first step towards making accurate wave measurements.

2.2.1 Background

Instruments that measure waves from below the surface perform this task in a variety of manners. The majority measure waves indirectly by a related property such as the dynamic pressure or orbital velocities.

When measuring currents with a Doppler system it is assumed that the velocities are horizontally homogeneous. However, when measuring waves this does not apply. Rather, it is assumed that the wave field is statistically stable, meaning that the same statistical result would be obtained if the same wave measurements were made just a moment later (a so-called short-term description). The other assumption is related to the Fourier analysis, which can be found in the [Statistical Approach](#) section.

The Aquadopp and AquaPro observe water level via the pressure sensor, water temperature and currents. The AWAC makes estimates by measuring time series of pressure, near-surface currents and Acoustic Surface Tracking (AST). It is important to remember that the instrument collects raw wave data. Therefore the data, by inspection, may not be entirely meaningful (except for perhaps the AST record). This raw data must go through a processing step before it can be used to interpret the waves on the surface. The processing will lead to classic wave estimates for height, period, and direction. Unlike the current profile estimates the wave processing is quite complex and is done in post-processing.

Orbital Velocity

The orbital velocity produced when a wave passes is the basic mechanism for obtaining information about the waves on the surface. When a wave propagates past a point it creates local currents below the surface. These currents are special in the sense that they are changing direction, whereby the crest of a wave will have the affected water below it moving in the direction of propagation, and the affected water below the trough moving in the opposite direction of the propagation, as illustrated in the figure below. This cyclical motion constructs a circular path in deep water and is often referred to as a wave's orbital velocity.

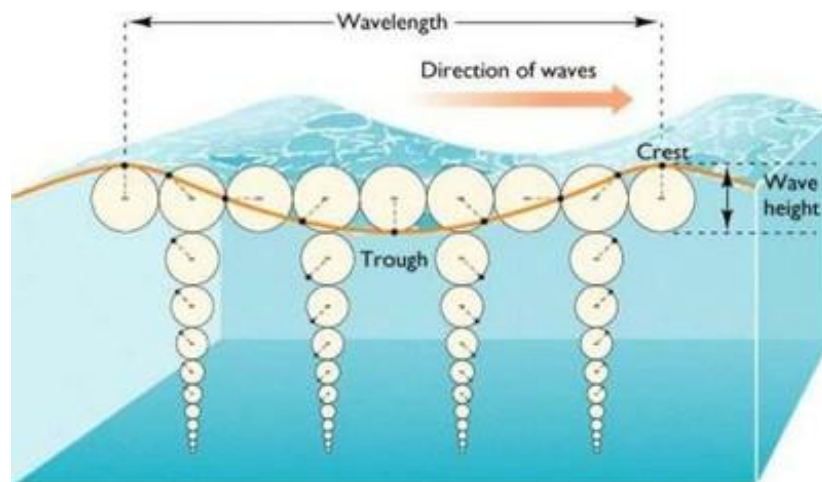

Figure: Description of the orbital velocities beneath a wave as it propagates. Note that the orbital velocity attenuates with depth.

The ability to measure the orbital dynamics from below allows us to interpret the waves on the surface, by use of linear wave theory. This provides the means to estimate many of the wave parameters that are commonly used to describe a sea state. An important detail to understand about orbital velocities is that they attenuate exponentially with increased depth and shorter wavelength. The wave energy will only propagate to a certain depth; the energy cannot be seen or measured below this depth. This means that short waves in deep water do not have an orbital velocity signal that penetrates to the bottom. Higher frequency waves attenuate more quickly with depth. Thus there exists a tradeoff between the depth of the measurement location and the ability to measure the higher frequency waves. This is exactly why we are both depth- and frequency-limited when measuring waves.

Dynamic Pressure

Another important property when measuring waves is the dynamic pressure. It is largely dependent on the presence of orbital velocities and this means it also experiences attenuation as a function of depth and wavelength (see figure below). The dynamic pressure is at maximum under the wave crest. The rate

of decrease with depth is well understood and modeled by linear wave theory. This allows us to measure the pressure near the bottom, and to rescale the measurement to obtain the wave elevation spectrum at the surface, by use of transfer functions.

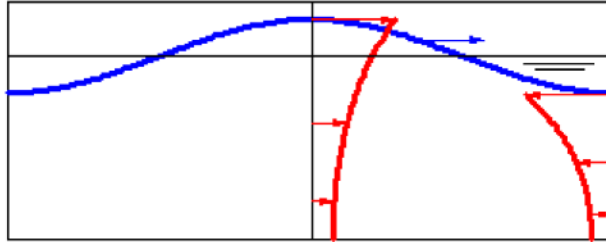

Figure: A wave moving in the direction of the blue arrow. The pressure profile is shown in red. Pressure and velocity (red arrows) under the crest are in phase with each other.

2.2.2 Sampling

Basic Sampling Requirements

Waves are random and therefore measuring waves requires sampling over a period of time that will best “capture” or represent the complete sea state statistically. The objective is to measure the wave event over a long enough time so that the random event can be properly characterized. Sampling theory suggests, as a rough rule of thumb, that the measurement duration is long enough to capture a minimum of 100 cycles of an event (i.e. a wave). When we measure ocean waves we have to consider what the longest expected wave period is going to be; 100 cycles of this longest wave will be the minimum wave burst duration. As an example, if waves are to be measured in the Mediterranean Sea, we would expect the waves to be 10 seconds or shorter. Therefore 10 seconds x 100 cycles is 1000 seconds. The sampling rate and number of samples defines the sampling length. A corresponding configuration could be either 1024 samples at 1 Hz or 2048 samples at 2 Hz.

In order to use Nortek-developed waves post-processing software, the instrument must be set in burst mode. The number of samples should be set to 1024, 2048, or a number consistent with the chosen sampling rate to ensure over 15 minutes of data is collected. If the number of samples is set to a number not in this sequence, the software will use the next lowest sequence number, e.g. if number of samples is set to 2400, the software will only use the first 2048 samples to calculate the wave parameters.

Sampling/Measurement Interval

The sampling or measurement interval specifies how often the instrument will collect wave data ensembles. This should be specified so that changes in the wave climate can be properly detected. Since wave events are relatively slowly developing events, choosing a relatively long interval make sense. A typical interval is every hour but may range from 0.5-3 hours depending on length of deployment time and available resources (battery and memory).

Sampling Rate

This is the sample rate for the wave data measurements and it applies to the pressure and velocity measurements. The sample rate represents the absolute upper limit on the resolvable waves. The upper limit is half the sample rate; this is also known as the Nyquist Limit. As an example, waves sampled at 1 Hz can only resolve waves up to 0.5 Hz, and waves sampled at 2 Hz can only resolve waves as short as 1 Hz. Note that there are other mechanisms, such as deployment depth, that can have a stronger

influence on the frequency limits of resolvable waves. If the sampling rate is too slow compared to the time variation of the motions, under-sampling is the result and the data is said to be "aliased" with respect to the wave motion, thus the waves cannot be well resolved.

Number of Samples

This is the number of data samples collected during a wave burst. The optimum choice for number of samples is used in conjunction with the sampling rate where the total burst length in time is considered. As with all measurements there is a trade off between accuracy of the estimates and the consumption of resources (battery power and memory). The consumption is considerably more for wave measurements than current profiles.

Burst Sampling vs Average Sampling

Wave data is collected in a mode that is referred to as Burst. The short version is that burst sampling mode takes rapid sampling over a specified time interval. Burst sampling is of particular use when there is an interest in sampling a specific part of the energy spectra.

2.2.2.1 Midlife Wave Sampling

The AWAC and AquaPro have two modes of operation; current profiling and wave bursts. The two modes are sequential; the system first collects a current profile, then it collects wave data for a period of time determined by the number of samples and the sampling rate. The system averages the full current profile over the prescribed averaging interval (illustrated in the figure below, in this example: 120 s). The whole sequence will start over again each measurement interval. Note that when specifying the number of samples and measurement interval in the deployment planning, there must be enough time to make a wave and a current measurement for each interval. A warning message will appear if there is a conflict.

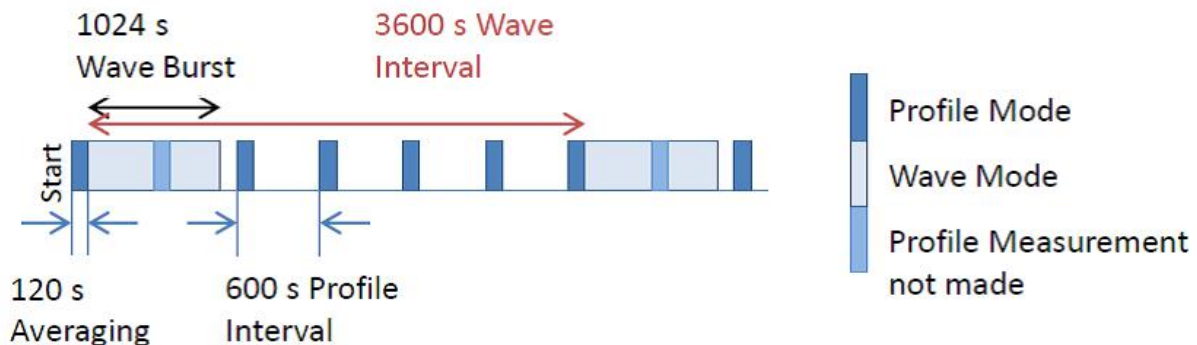

Figure: The AWAC and AquaPro measures profile and waves sequentially. In case of conflict, wave measurements are given priority over profile measurements. Note that the intervals are user selectable in the software; this is just an example.

AWAC: The instrument will not do profiling and wave burst measurements at the same time; the wave measurements are given priority. The skipped current profile can be interpolated in the ASCII conversion software afterwards if desired.

One may view the AWAC wave measurements as two separate operations which permit the ability to estimate both directional and non-directional wave parameters:

1. The three beams slanted off to the side measure wave-generated orbital velocities from which one can extract the directional parameters. Each beam measures the velocities in a wave cell. Managing the

fact that orbital velocities attenuate exponentially with depth means that the wave cells are measured close to the surface, while ensuring that there is no contamination from the surface, either directly from the cells touching the surface or indirectly from sidelobes. This will in most cases be managed by the instrument, by adaptively positioning the cells just below the surface by using the information from the pressure sensor. There is also an option of setting the wave cell statically in the software, but this is generally not recommended unless you know exactly where the surface will be at all times during the deployment.

2. The fourth vertical beam works as an altimeter and measures the distance to the surface directly ([Acoustic Surface Tracking](#), AST). It thus traces the surface wave profile as it passes through its field of view. The AWAC has a relatively large fixed altimeter window as the field of view. This window is also set adaptively if "static mode" is disabled. The AST measurements occur at twice the rate of the pressure and velocity; for example, by selecting 2 Hz sampling rate you really choose 4 Hz surface tracking/non-directional wave measurements.

Wave bursts occur directly following a current profile. The information gathered during the current profile is used to place the wave measurement volume (wave cell and AST window).

AquaPro (and non-AST AWACs): The AquaPro is limited to 1 or 2 Hz wave sampling rate. The [PUV approach](#) cannot detect short waves with a period less than 1 second due to the attenuation effects associated with the deployment depth and wave frequency. The pressure sensor is within the transducer head and therefore this is from where to measure the mounting height.

Since the Aquadopp Profiler measures waves using the current cells above it, care should be taken to ensure that the cell does not touch the surface. The measurement volume begins 0.5 meters above the transducer head and ends at a distance two times the cell size. The user has the option to choose the cell size to use. It is advisable to choose a cell size as close to 2 meters as possible, where the limitation should only be proximity to the surface and power usage.

Aquadopp: The Aquadopp can use the "diagnostic" mode to configure the instrument to burst sample velocity and pressure at 1 Hz, in order to make directional wave measurements with the [PUV method](#). Note that the first sample in the burst mode is the noise floor measurement (no signal transmitted) and is therefore not used in the wave measurements. Similar considerations should be used here as was done with the AquaPro.

When setting up the Aquadopp for wave measurements, the user must select the "Use Advanced Settings". Then once in advanced settings, check the "Diagnostics" box. The Aquadopp uses a sampling rate of 1 Hz so it is encouraged to use 1024 samples. Note: The first sample in the burst is the noise floor and therefore not used in the wave measurements. This means that the number of samples must be set to $2n+1$. For example the number of samples could be 513, 1025, or 2049 ($n = 9, 10, 11$).

2.2.2.2 Signature Wave Sampling

The instrument will be configured to sample a number of samples at a certain sample rate every measurement interval (check SignatureDeployment software help file for details on this). One may view the Signature's measurements as two separate operations which permits the ability to estimate directional and non-directional wave parameters:

1. The four beams slanted off to the side measure wave generated orbital velocities. Each beam measures a truncated profile - or one sufficiently capturing the orbital velocities. From the recorded profile one may select a level below the surface where the measurements form an array projected from the Signature to just below the surface. Managing the fact that orbital velocities attenuate exponentially with depth means that the data used for wave processing are the ones that are measured close to the surface, while ensuring that there is no contamination from the surface either directly from the cells touching the surface or indirectly from sidelobes. This can be managed by adaptively positioning the cells just below the surface by a fraction of the measured depth; 10-15% of the depth has proven to provide a good signal response without contamination.
2. The vertical fifth beam works as an altimeter and measures the distance to the surface directly. It thus traces the surface wave profile as it passes through its field of view. The Signature series instruments have a relatively large, fixed altimeter window, which is defined at the configuration stage with the Altimeter Start and Altimeter End parameters. Wave processing will select a suitable wave cell per wave burst, so it will change depending on the tidal conditions. The data are processed by using the Nortek AST routine.

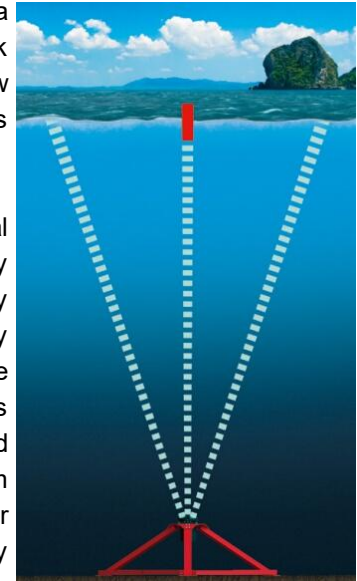

Figure 1: Sampling area of the Signature while measuring waves.

Sampling timings and measurement load

Unlike the midlife instruments, the Signatures can measure Average and Burst measurements in the same second, and measurement slots are allocated according to the measurement load chosen. The number of slots an instrument can allocate to depends on its maximum sampling rate. In the example below, a Signature1000 (16 Hz max sampling) is being configured with both average and wave measurements at 2 Hz with different measurement loads.

A high measurement load increases the number of pings, and therefore improves the precision (more pings = more information about the water column). A higher measurement load increases the power consumption as well. Conversely, a lower measurement load will decrease the number of pings and the power consumption, but the measurements will be less precise.

Average (min measurement load, 1 ping) with wave height and direction (2 Hz, 3 pings)

t=1/16	t=2/16	t=3/16	t=4/16	t=5/16	t=6/16	t=7/16	t=8/16	t=9/16	t=10/16	t=11/16	t=12/16	t=13/16	t=14/16	t=15/16	t=16/16
Alt	Avg	B4		B4		B4		Alt		B4		B4		B4	

Average (max measurement load, 4 pings) with wave height and direction (2 Hz, 3 pings)

t=1/16	t=2/16	t=3/16	t=4/16	t=5/16	t=6/16	t=7/16	t=8/16	t=9/16	t=10/16	t=11/16	t=12/16	t=13/16	t=14/16	t=15/16	t=16/16
Alt	Avg	B4	Avg	B4	Avg	B4	Avg	Alt		B4		B4		B4	

Wave height and direction (2 Hz, min measurement load , 1 ping)

t=1/16	t=2/16	t=3/16	t=4/16	t=5/16	t=6/16	t=7/16	t=8/16	t=9/16	t=10/16	t=11/16	t=12/16	t=13/16	t=14/16	t=15/16	t=16/16
Alt	B4							Alt	B4						

Wave height and direction (2 Hz, max measurement load, 7 pings)

t=1/16	t=2/16	t=3/16	t=4/16	t=5/16	t=6/16	t=7/16	t=8/16	t=9/16	t=10/16	t=11/16	t=12/16	t=13/16	t=14/16	t=15/16	t=16/16
Alt	B4	B4	B4	B4	B4	B4	B4	Alt	B4	B4	B4	B4	B4	B4	B4

Setup considerations

- Waves are random and therefore measuring waves requires sampling over a period of time that will best “capture” or represent the complete sea state. For long waves, it may be necessary to increase the overall sampling period in order to ensure a proper statistical presentation. As a rough rule of thumb try to get 100 cycles of the longest wave we would expect; this means if the longest expected wave period is 10 seconds for a particular body of water, then 1000 seconds is the preferred sampling length.
- Specific recommendations cannot be provided other than the sampling rate needs to be at least twice as fast as the signal of interest in order to resolve it unambiguously (i.e. the Nyquist sampling criteria).
- Mounting depth: Orbital velocities attenuate exponentially with depth and this behavior is more severe for higher frequency waves (short waves). This means that the further down in the water column that the orbital velocities are measured, the less high frequency information is available. This is the classic problem faced by bottom mounted instruments, and note that even the ADCP class of instruments suffers from this challenge if it is not managed effectively.
- Mounting angle: Since the vertical acoustic pulse is reflecting from the surface the best response occurs when the pulse path is orthogonal to the surface from which it is reflecting. The return response deteriorates as the beam deviates from the vertical. Performance is notably reduced when the tilt exceeds 5 degrees, and the data can be considered completely unusable if the tilt exceeds 10 degrees.
- Mounting method: If the instrument is to be deployed on a subsurface buoy, make sure that the natural frequency of the buoy itself is not the same of the wave frequencies being measured. There is more information about this in our [Comprehensive Manual](#).

2.2.3 Statistical Approach

Since the sea surface is composed of different types of waves and in general is irregular in both time and space, the sea state is characterized by statistics (wave height, period, direction etc.). A couple of assumptions are necessary when trying to approximate the wave field; the first is that the wave field can be described as a summation of many different sine waves with different frequencies, amplitudes and directions. This makes it possible to use Fourier analysis to reduce a time series of waves to a certain number of sine waves. Fourier analysis is a mathematical method used to break down and transform a periodic function into a set of simpler functions (e.g. sine and cosine) thereby providing a simpler, general solution. For more information, see a textbook covering signal processing, for example Data Analysis

Methods in Physical Oceanography. The second assumption is that the wave field is statistically stable, meaning that the same statistical result would be obtained if the same wave measurements were made just a moment later (a so-called short-term description).

2.2.3.1 Time Series

The simplest method for estimating wave parameters is to evaluate the time series of sea surface displacement from a single measurement point. The resulting time series analysis determines how far the water surface extends above and below the mean water level. Individual waves can then be determined by where the trace crosses the mean level; this is commonly referred to as the zero crossing method (see figure below). The individual waves in the record can be characterized by period (defined by where it crosses the mean water level) and height (defined by the distance from trough to crest between crossings). The result of this exercise is a wave record composed of many waves with a variety of heights and periods. If these waves are ranked by their height and/or period then the resulting rankings can be used to calculate common estimates of height and period.

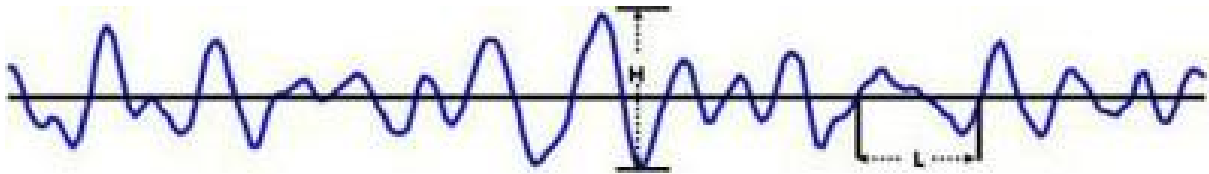

Figure: Example of a time series of the surface displacement. Here the zero-crossing technique is used to determine individual wave heights (H) and wave periods (L).

2.2.3.2 Spectral Analysis

The time series analysis may seem like the appropriate manner to approach wave measurements. However, two common restrictions keep many from succeeding. The first restriction is that time series analysis can be a little daunting; the second is that many wave measuring devices do not have the technology to directly measure the surface displacement and, therefore, do not allow for the possibility of time series analysis. Instead, they measure a wave related property such as pressure or orbital velocity (cf. next section) and infer the sea state from the spectra of the time series.

A different approach is the spectral analysis, made possible by application of Fourier transforms. A given trace of the waves can be analyzed by using Fast Fourier Transform (FFT) to produce energy density spectra (see figure below). The spectrum shows how the energy density is related to different frequencies. Having obtained a spectrum, the frequency domain wave parameters may be found. Both the ease of interpretation and large number of non-direct measuring instruments has left spectral analysis as the primary method for processing wave results. It provides an enriched collection of wave parameters and also permits directional wave analysis.

The most complete solution is both a time series analysis and spectral analysis.

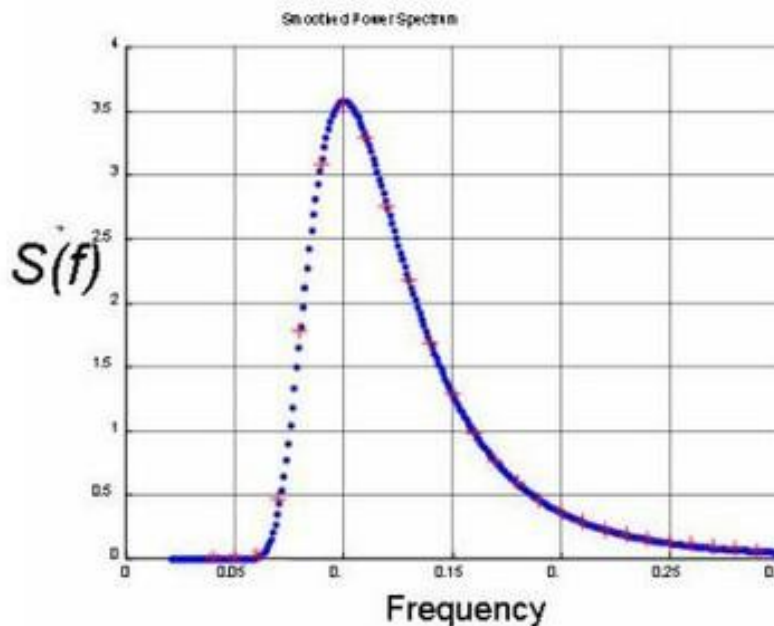

Figure: Energy density spectrum for a time series. This is ultimately used for estimating wave parameters of height and period.

2.2.4 Processing Methods

The resulting time series of the raw measurements is not particularly useful from a practical standpoint. The wave data therefore needs to be processed to yield the parameters presented in the previous section that can broadly, yet accurately, characterize the sea state. Nortek uses the following methods.

2.2.4.1 PUV

This method was perhaps the first approach used for measuring directional and non-directional wave properties from below the surface. It dates back to the 1970's and because of its modest requirements for instrumentation and processing, it is still in use to this day. Nortek offers three instruments using PUV measurements; the Aquadopp, AquaPro and Vector (refer to the [Comprehensive Manual for Velocimeters](#)).

The name itself is a description of the method as it is an abbreviation of the three quantities measured: Pressure and the two horizontal components of the wave's orbital velocity, U and V. These measurements are made at the instrument's deployment depth and because they are co-located at the same point, this is referred to as a "triplet" measurement.

The PUV analysis must provide an accurate estimate of the wave elevation spectra in addition to the direction and the directional spreading. The dynamic pressure measurement provides a means of estimating all the non-directional wave parameters, while the combined P, U, and V measurements allow for estimating the directional wave parameters.

Since these estimates are based on the wave energy distribution, and not a direct measure of the free surface, they are considered inferred estimates. Fourier transforms are used to separate the signals into different frequency bands so that it can determine the direction separately for each band. This means that if you have a long-period swell coming from one direction, and a shorter period coming from another,

you can tell the direction for each of them separately. The main assumption for standard PUV wave measurements is that waves at a given frequency come from one primary direction.

The most important thing to understand about the PUV method is that it is limited to (a) deployment depths that are shallow (less than 10 meters) and (b) waves that are long (approximately periods of 4 seconds or longer). Take a look at [this technical note](#) for more information. The limitations are a result of the fact that the orbital velocity attenuates with depth. The limitation of only measuring long waves (swell) is the one that should raise a warning flag for those who are interested in the complete description of the wave environment. As an example, the PUV may be successfully used if one wants to investigate a structure's response only to swell in shallow water. The accuracy of the solution requires measurements over the entire wind wave band (waves with periods of 0.5-30 seconds). Incomplete coverage of the wind wave band can result in underestimation of wave height and missing peaks in the spectrum. The only way to improve the coverage of the wind wave band is to deploy the instrument in relatively shallow water (i.e. 3 meters depth).

2.2.4.2 MLM

The shortcomings of the PUV method prompted the development of a new technique for measuring waves. This new technique involves employing current profilers to measure orbital velocities closer to the surface where the velocities are less attenuated by depth. As a result, the shorter waves could be measured at greater depths. A more complex processing method is required since the measurements are no longer co-located (triplet measurements), but are in the formation of an array of measurement cells ("Projected Array"). The most common array processing method is the Maximum Likelihood Method (MLM), a method that has demonstrated very favorable results. There is an effective doubling of performance; the deployment depth can be doubled or the cutoff period is reduced by half. The MLM makes it possible to resolve the wave field in every direction.

The directional estimates of short waves are limited by the size, or the horizontal separation distance between the cells, of this projected array - which again is dependent upon the deployment depth. As the deployment depth increases, so does the horizontal separation between individual measurement cells. Increased separation distance will lead to a larger minimum wavelength that can be resolved for directional estimates. A rough rule of thumb is that directional estimates for waves that have a wavelength that is two times the separation distance or greater can be resolved unambiguously. This aliasing presents a spatial Nyquist limit and leads to a cutoff frequency where wave directions cannot be resolved. For example, a gauge deployed 40 m below the surface has a directional cutoff frequency of about 0.22 Hz (4.5 seconds). This means that the gauge will not be able to resolve directions from waves shorter than 4.5 seconds. The cut-off frequencies for the AWAC and the Signature1000 can be seen in the figure below.

An important detail about the array solution is that the complete wind wave band (0.5-30 seconds) is still not covered and underestimation is possible if the instrument is deployed in typical coastal depths (e.g. greater than 15 meters).

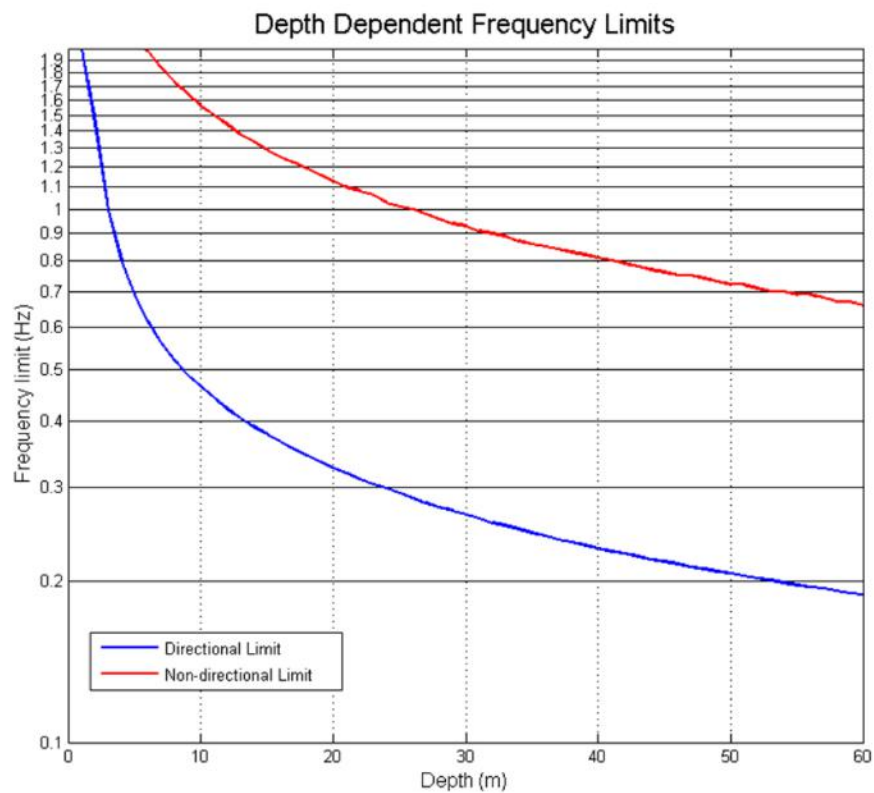

Figure: The cutoff frequencies for the AWAC - both for directional and non-directional estimates. This limitation is a result of the horizontal spacing of the velocity cells that construct the array near the surface.

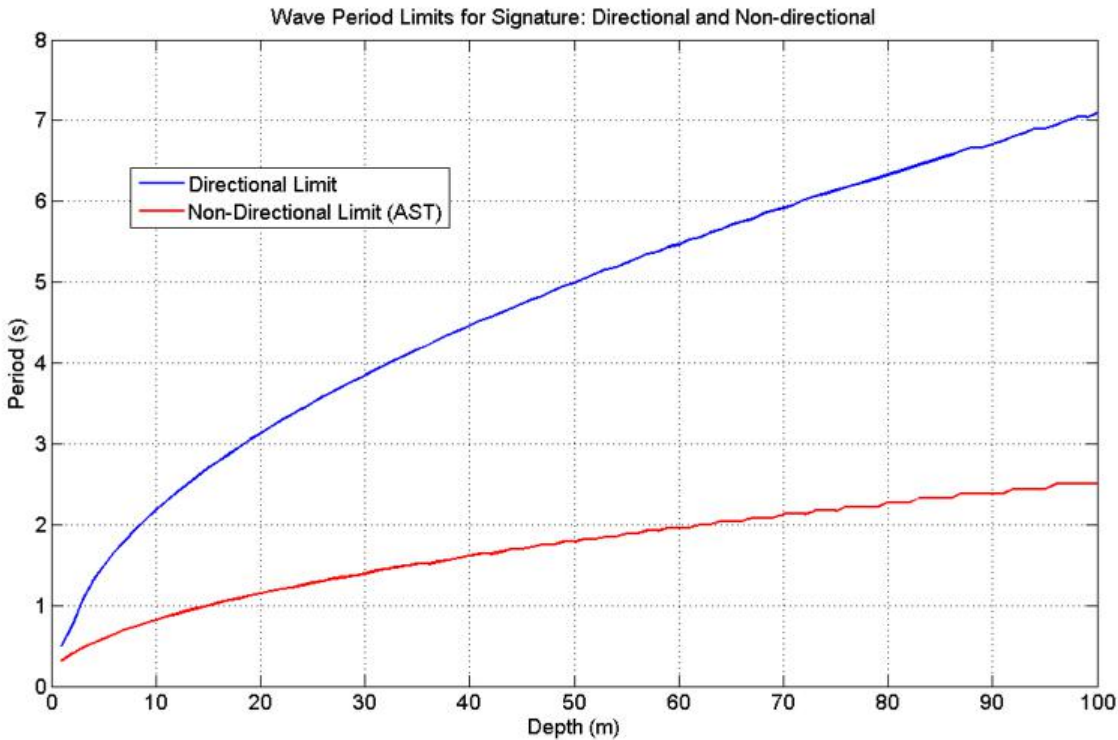

Figure: The cutoff frequencies for the Signature1000 - both for directional and non-directional estimates. This limitation is a result of the horizontal spacing of the velocity cells that construct the array near the surface.

Directional limitation

The directional limitation lies within the relationship of the wavelength and separation distance of the measurement cells.

- The shortest period wave is limited by the rule that one can only unambiguously estimate direction for waves that have a wavelength that is two times the separation between the closest cells.
- The spatial separation of the cells will depend on the depth of the instrument, as the distance between the measurement cells will increase with distance from the instrument.

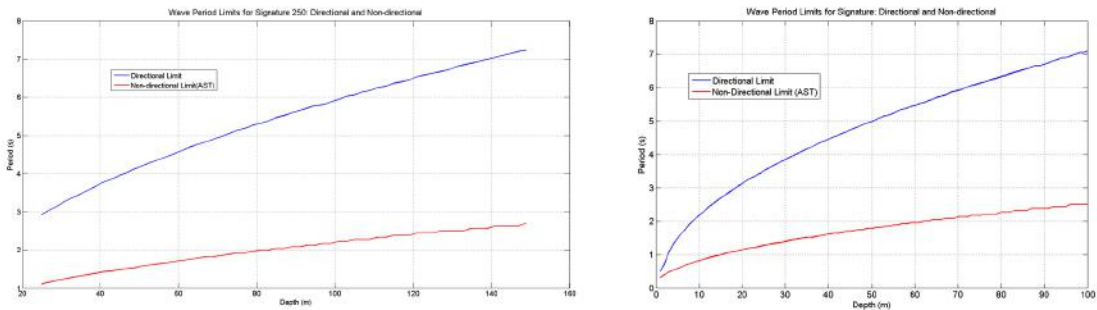

Figure 2: Shows the directional and non-directional limitations for different instrument depths and different wave periods. To the left: Signature 250. Right: Signature1000 and Signature500

One perceived solution is to position the measurement cells closer to the instrument such that the spatial separation is reduced and consequently the frequency at which this ambiguity occurs is higher. Unfortunately, moving the measurement cell further down in the water column means that the orbital velocity signal may disappear. The result is that there is no performance gain by drawing the cells in closer to the instrument.

2.2.4.3 Acoustic Surface Tracking (AST)

In 2002, the AWAC was first released with the AST option, and this method has been carried over into the Signature series of instruments. The vertically oriented transducer in the center of the instrument uses the echosounder principle; the travel time from the instrument to the surface and back allows us to estimate the distance to the surface for each ping. The strong impedance mismatch at the water-air interface provides a near perfect reflection, and thus provides a strong return. Although the transmit pulse is rather short, we have a large receive window so that we ensure a surface detection.

The raw AST data outputted by the instrument is a time series with distances to the surface. The approach used by the instrument to detect the surface is relatively simple, and can be broken down into the following sequence of automatic steps:

1. Transmit a relatively short pulse
2. Specify a receive window covering the range of all possible wave heights
3. Discretise the receive window into multiple cells (~5 cm) to achieve high resolution of the surface
4. Apply a match filter over series of cells to locate the maximum peak, which is the surface
5. Use quadratic interpolation of the peak point and its neighbors to precisely estimate surface location - the final resolution of the distance to the surface is 1 mm.

A cleanup step is iteratively performed on the raw time series and if the cumulative number of false and no detects exceeds 10% of the total number of samples in the ensemble, the ensemble is considered corrupt and discarded. The resulting time series of the raw measurements is not particularly useful from a practical standpoint, and therefore needs to be processed to yield parameters that can broadly, yet accurately, characterize the sea state.

The record of the distance to the sea surface gives the user the possibility to see the exact wave profile. The direct measure has many advantages; the first, and most profound, is that there is effectively no depth limit for coastal waters and that the largest possible portion of the wind wave band is covered. The AST measurement also allows for both time series and spectral analysis. This means design parameters such as H10 and Hmax can be measured directly.

The ability to measure the wave parameters by use of AST is limited by the size of the area that is ensonified by the AST beam, called the AST footprint. The size of the footprint is determined by a) the beam width, and b) the instrument distance from the sea surface. The size of the footprint will increase with increased beam width or with greater distance from the surface. The [cutoff frequency](#) (limit of the shortest measurable wave) is affected by the size of the footprint. When the diameter of this footprint becomes similar in size to a wavelength, then the structure of the waveform (crest and trough) cannot be well resolved. There is an average of the distance over the waveform and thus a "smearing" of the true features. As a rule, we follow a Nyquist-like reasoning; the frequency limit associated with the footprint is

when half the wavelength is on the order of the diameter of the footprint. This clearly is the absolute shortest measurable wave. Below you will find a table that shows deployment depth, footprint size, and the resulting shortest measurable wave. The AST circumvented most of the shortcomings associated with subsurface wave measurement instruments and allows for the best possible coverage of the wind wave band.

➔ Example: The Signature250 is to be deployed with a distance to the surface of 80 m, and the footprint on the surface from the altimeter beam will be $80 \cdot \sin(2.2)$. The minimum wavelength needs to be the twice of this footprint, that means ~ 6.15 m. One can then use simple wave theory to find an equation that relates wavelength (L) to wave period (T); $L = gT^2/2\pi$. Using this equation, the minimum wave period measurable at 80 m depth is ~ 2 s.

Depth [m]	Footprint diameter [m]	Wavelength [m]	Wave period [s]
6	0.30	0.61	0.7
12	0.61	1.22	1.0
24	1.22	2.43	1.2
36	1.82	3.65	1.5
48	2.43	4.86	1.8
60	3.04	6.08	2.0

Table: Depth dependent AWAC with AST minimum limits.

2.2.4.3.1 MLMST

The MLMST is a version of the array method, adapted for surface tracking measurements instead of pressure measurements. The AST is included in the MLM solution to improve upon the accuracy of the directional estimates. Wave orbital velocity measurements are still made close to the surface like the array solution, but instead of the dynamic pressure, the AST option is utilized to estimate the non-directional spectrum. This is an adequate solution for a bottom-mounted instrument. The directional estimates are limited by the horizontal separation of the wave measurement cells and AST, and the non-directional estimates are limited by the AST footprint, as described in the previous section.

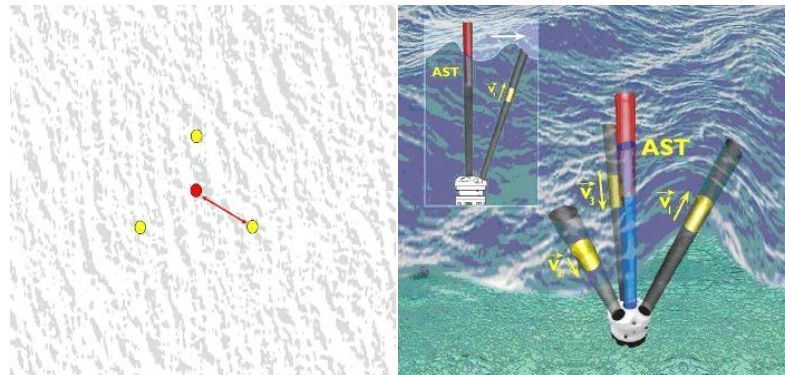

Figure: (a) looking down from above at the array of measurements from the AWAC, and (b) AWAC and the array of measurements cells for orbital velocity measurements (yellow) and the Acoustic Surface Track option (red).

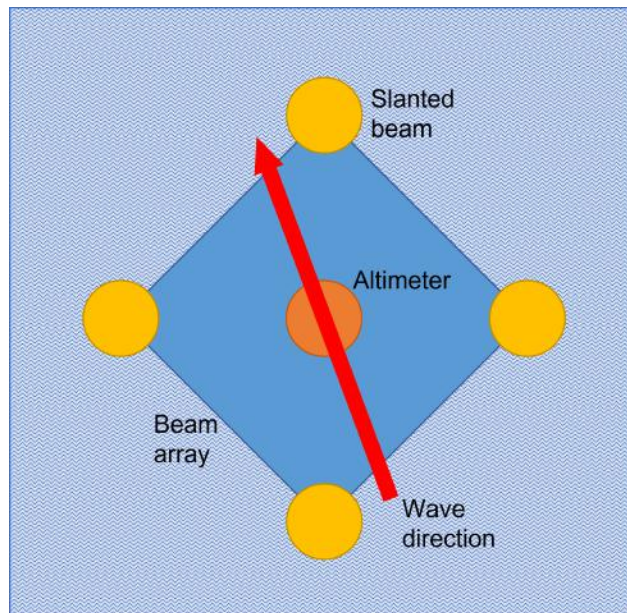

Figure: Downlooking view of the array created on the surface by the beams of the Signature.

2.2.4.3.2 SUV

If the position of the measurements in the surface array are not stationary (if the instrument is mounted in a subsurface buoy there will always be some motion), then array processing methods like MLM and MLMST become mathematically impossible to solve and cannot be used. Nortek developed the SUV method to solve the problem of directional wave measurements from a moving subsurface buoy. This means that when wave measurements are desired in waters where it is not possible to use an array solution (60-100 meters deep) the instrument may be placed in a subsurface buoy and positioned closer to the surface (e.g. 30 meters below the surface). The result is that the instrument measures directional wave characteristics as if it was mounted on a seabed at 30 meters, yet it has the flexibility to be mounted at depths determined by the subsurface buoy's mooring system. Wave orbital velocity measurements are still made close to the surface like the array solution, but instead of an array, the velocities are converted to the co-located velocity components of U and V (see c) above). The other difference is that the dynamic pressure is replaced by the AST option.

The method may also be used for bottom-mounted deployments. The method is also better suited (than MLM) for deployments where the waves are exposed to large mean currents. Mean currents can present a Doppler shift on the wave field and introduce errors in the directional and non-directional estimates if not corrected, due to the fact that the transfer function used is wavenumber dependent. The SUV method does not require a correction for background currents because both the AST and the directional portion of the measurement do not have transfer functions, and so are not wavenumber dependent.

Nortek's post-processing software packages recalculate the wavenumber when the MLMST method is used, but we recommend using the SUV method in places with known background currents to avoid any sources of error from the correction being introduced.

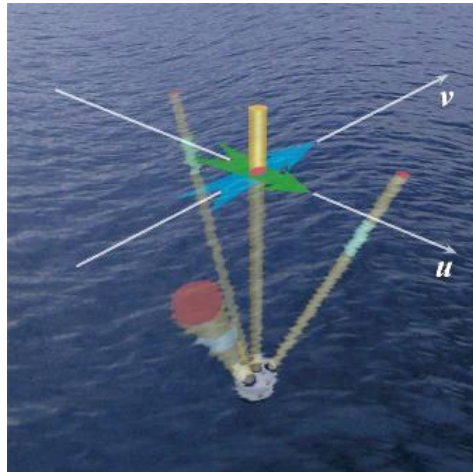

AWAC using the SUV method to capture AST and U/V measurements.

2.2.5 Wave Parameters

The resulting time series of the raw measurements is not particularly useful from a practical standpoint, and therefore needs to be processed to yield parameters that can broadly, yet accurately, characterize the sea state. The Signature does not process wave data internally, but post-processing software does exist.

The resulting wave parameters can be put into the two categories introduced above; non-directional parameters (wave height) and directional parameters (wave direction).

- Non-directional parameters cover parameters that do not depend on the direction of the waves, and comprise: Peak Period (T_p), Mean Period (T_{m02}), Mean Zero-crossing Period (T_z), Mean 1/3 Period (T_3), Mean 1/10 Period (T_{10}) and Maximum Period (T_{max}), Significant Wave Height (H_{m0}), Mean 1/3 and 1/10 Height (H_3 and H_{10}), Maximum Height (H_{max}), and Mean Height (H_{mean}),
- Directional parameters cover Peak Direction ($DirTp$), Directional Spread ($SprTp$), and Mean Direction ($Mdir$). Note that wave directions are always reported as the direction from which the waves are coming.

2.2.5.1 Non-Directional

The most common non-directional wave parameters describe height and period of the wave field and are single values representative of the time series. The instruments collect raw wave data that must go through a [processing step](#) before it can be used to interpret the waves on the surface. The processing will lead to classic wave estimates for the following wave parameters:

Period (T) is defined as the time interval between two successive peaks (or troughs) passing a fixed point, measured in seconds. The Peak Period (T_p) is the period associated with the maximum peak in the spectrum. It is found using the spectral analysis method, and it tells the characteristic frequency of the arriving wave energy (remember that frequency is the inverse of the period). The only parameter needed to find the peak period is one that varies with the wave frequency, which may be the water level, the pressure or the orbital velocity. To find the peak period, the spectral analysis is used on the time series of the parameter used to determine out the frequency with the most energy. The Mean Period (T_z) is the mean of all the wave periods in the record.

Wave height (H) is the vertical change in height between the crest and the trough. The wave height is twice the amplitude (a). The parameter most used by oceanographers to characterize a particular sea state is the significant wave height (Hs or Hm0) defined as the mean of the highest 1/3 of all waves in the record's ranking. Classically, this estimate is performed by sorting all waves in a time record according to height (referred to as Hs). However, in our approach, we utilize the spectrum of the sea surface to approximate this value. A generally accepted approximation is:

$$H_{m0} = 4.0\sqrt{m0}$$

Here $m0$ represents the first momentum of the power spectrum. The k^{th} momentum is defined by:

$$m_k = \int f^k C(f) df$$

where C is the power spectrum, and f is the frequency.

Other wave height parameters of interest are the maximum wave height (Hmax), which is simply the largest measured wave in the record, and the mean of the largest 10% of all waves in the record (H10). These two parameters are commonly used for coastal design and assessment and are only possible when we have a direct measure of the surface displacement (e.g. AST). Indirect measurements of waves cannot produce these parameters; however they can be presented as linear extrapolations of Hm0 (H10 = 1.27*Hm0 and Hmax = 1.67*Hm0).

2.2.5.2 Directional

Calculated wave directions are based on the first pair of Fourier coefficients and describe the mean direction at a given frequency. The directional wave spectrum is commonly expressed as a composition of the frequency spectrum and the directional spreading:

$$E(f, \theta) = S(f) \times D(f, \theta)$$

Here, f is the frequency, θ is the direction, E is the full directional spectra, S is the energy density spectra (frequency spectrum), and D is the normalized energy spectra (directional spreading). The energy density spectrum is retrieved by spectral analysis for the time series of surface elevation (pressure, AST, orbital velocities), while the estimation of the directional spreading use a combination of the measurements taken; dynamic pressure + orbital velocities or AST + orbital velocities. The directional distribution can be approximated by a Fourier expansion according to:

$$D(f, \theta) = \frac{1}{\pi} \left[\frac{1}{2} + \sum_n \{a_n \cos n\theta + b_n \sin n\theta\} \right]$$

The cross-spectrum is a measure of the similarity of two different measured parameters, clarifying if they are varying together. If they vary at the same frequency, then it is likely they are related. The full cross-spectrum is presented as

$$C_{xy} = S_x S_y^*$$

where the * indicates the complex conjugate [2]. The cross-spectrum is calculated between every sensor, and the directional spectrum is assumed to be linearly related to the cross-spectrum. It has

been shown that the first two pairs of Fourier Coefficients can be expressed in terms of the cross-spectrum [2]:

$$a_1(f) = \frac{C_{*u}}{[C_{**}(C_{uu} + C_{vv})]^{1/2}}$$

$$b_1(f) = \frac{C_{*v}}{[C_{**}(C_{uu} + C_{vv})]^{1/2}}$$

$$a_2(f) = \frac{C_{uu} - C_{vv}}{C_{uv} + C_{vu}}$$

$$b_2(f) = \frac{2C_{uv}}{C_{uu} + C_{vv}}$$

Here, C_{uv} represent the cross-spectra of the u and v velocity components. C_{uu} and C_{vv} are the velocity component power spectra, and C_{**} is the pressure (C_{pp}) or the surface elevation spectra (C_{ss}) (depending on the method used). Generally, the two parameters defining the directional distribution is the mean wave direction (θ_1) and the directional spreading (σ). The mean direction is expressed as:

$$\theta_1 = \arctan2(b_1, a_1)$$

The directional spreading is calculated as:

$$\sigma = \sqrt{2(1 - r_1)}$$

where

$$r_1 = \sqrt{a_1^2 + b_1^2}$$

Note that wave directions are always reported as the direction where the waves are coming from.

2.2.5.3 Wave Parameters (Processed)

Acronym	Description	Range	Note	
Hm0	Calculated from energy spectrum. Known as Significant Wave Height, defined as the mean of the highest 1/3 of all waves in the record's ranking.	$Hm0 = 4.0 \times \sqrt{m0}$ <i>m0 represents the first moment of the power spectrum, defined as</i> $m_q = \int_{f_{start}}^{f_{end}} S(f) f^q df$	0-20 m	
H3	Time series based estimate. Mean of the 1/3 largest waves in a record.	Zero up crossing	Typically 5% smaller than Hm0	AST only
H10	Time series based estimate. Mean of the 1/10 largest waves in a record.	Zero up crossing	1.27*Hm0	AST only
Hmax	Time series based estimate. Largest wave in a record.	Zero up crossing	1.67*Hm0	AST only

Hmean	Time series based estimate. Mean values of all waves in a record.	Zero up crossing		AST only
Tm02	Calculated from energy spectrum. Mean period.	$Tm02 = \sqrt{\frac{m0}{m2}}$		
Tp	Calculated from energy spectrum. Peak period of the waves corresponding to the peak frequency.	$Tp = \frac{1}{f_{peak}}$		
Tz	Time series based estimate. Mean period. This is a direct measurement unlike the spectral equivalent, Tm02.	Zero up crossing		AST only
T3	Time series based estimate. Period associated with the 1/3 largest wave in the record H3.	Zero up crossing		AST only
T10	Time series based estimate. Period associated with the 1/10 largest wave in the record H10.	Zero up crossing		AST only
Tmax	Time series based estimate. Period associated with the largest wave (Hmax) in a record.	Zero up crossing		AST only
TpDir	Calculated from energy spectrum. Peak direction is the wave direction at the frequency at which a wave energy spectrum reaches its maximum.	Zero up crossing	0-360°	Reported as "from"
Spr1	Calculated from energy spectrum. Measure of the directional variance at peak frequency.	$spr1 = \sqrt{2 \times (1 - r_1)} \times \frac{180}{\pi}$ $r_1 = \sqrt{A1^2 + B1^2}$ <i>A1 and B1 are the first pair of Fourier coefficients at the peak frequency</i>	0-360°	
Mdir	Calculated from energy spectrum. Main direction. Weighted average of all the directions in the wave spectrum.	$A1_{band} = \frac{\int S(f) \times A1(f)}{\int S(f)}$ $B1_{band} = \frac{\int S(f) \times B1(f)}{\int S(f)}$ $Mdir = atan2(A1_{band}, B1_{band})$ <i>For this case the "band" is the entire frequency range of the energy spectrum</i>	0-360°	Reported as "from"
Unidirectivity index	Calculated from energy spectrum. Measure of how much of the wave energy over the full spectrum is from a single direction. Value of 1.0 indicates the energy is from one primary direction.		0.0-1.0	

2.2.5.4 Measurement Errors, Uncertainties and Corrections

Measurement Errors

Measurements are estimates of the value of something real. Given a real wave direction, each measurement is an estimate of this direction. If the instrument happens to be measuring waves with infinitely-long, parallel crests, wave direction is easy to define; it is perpendicular to the wave fronts. However, real waves are rarely so simple. At any given time, wave spreading blurs the wave direction, making the real wave direction meaningful only as an average.

Wave direction measurements are similar. Each direction measurement is an estimate of the mean wave direction, but when making many independent estimates, they differ from one another. Averaging many independent wave direction measurements enables you to get a better estimate of the actual mean direction of the waves you are observing. Averaging estimates together usually improves the measurement. If your estimator is unbiased, then the more you average, the better your estimate becomes. Some estimators are biased, however. No matter how much you average a biased estimator, you will always have a residual error; that is, a residual difference between your mean estimate and what you are measuring. Even so, there is value in averaging biased estimates for two reasons: 1) The bias is often smaller, or even much smaller, than the random errors you can remove with averaging. 2) If you understand the characteristics of the bias, you can correct a biased estimator to obtain a better estimate.

Uncertainty

There are three primary factors in the uncertainty:

1. The actual directional spread of the waves themselves. Uncertainty in the mean wave direction is proportional to the spreading of the waves.
2. SNR or signal/noise ratio. A noisy measurement increases the apparent spreading and the uncertainty of the measurement.
3. Averaging. Like most estimators, averaging produces more accurate estimates.

The directional estimator is unbiased, so averaging should always reduce the uncertainty. In contrast, the spreading estimator is biased. Averaging still helps, but you will always have a residual bias, the magnitude of which depends on the amount of spreading.

Correction for Background Currents

In case of strong background currents, the measured waves may be affected by a Doppler shift. That is, when currents are directed against the waves, the waves are compressed. When the currents travel in the same direction, the waves are elongated. The resulting spectra will see the peak energy shift slightly to lower or higher frequencies. It is not just the magnitude of the currents that is essential but also the direction. Currents flowing in a direction perpendicular to the wave direction will have no effect on the waves.

The degree to which the Doppler shift modifies the surface waves depends on the current speed relative to the wave propagation speed. This means that slow propagating (short period) waves are the most affected by currents. Measurements that infer the surface waves from either orbital velocity or pressure measurements require special attention regarding background currents. This is because the transfer function used for inferring the surface waves is wavenumber dependent, and it is the wavenumber that is modified by the background currents. The wavenumber solution must take into account the mean current and direction relative to the wave direction. The post-processing method that relies on the wavenumber

solution is the [PUV method](#), and it is the one which is most sensitive to the effects of currents. The correction for background currents is done in post-processing software when necessary, by recalculating the wavenumber based on the Doppler shift from the background currents. Acoustic Surface Tracking is a direct measure of the surface waves and therefore its response is unaffected by background currents.

2.2.6 Additional Reading

Transfer Functions

Both the dynamic pressure and the orbital velocities are driven by the surface waves. The signals associated with these properties are complicated by the fact that they attenuate exponentially with depth. The exact behavior of the attenuation has to do largely with the water depth and the wavelength. Briefly, the behavior is as follows: (1) as we move down in the water column the signal is increasingly attenuated, (2) as the wavelength decreases (shorter period or higher frequency) the signal again experiences increasing attenuation. We use linear wave theory to convert pressure and velocity spectra to surface elevation spectra. The pressure attenuation factor is given by

$$T_p = \frac{\cosh k(h+z)}{\cosh kh}$$

and for the velocity as

$$T_v = \frac{\omega \sinh k(h+z)}{\cosh kh}$$

Here, h is the water depth, z is the position in the water column, ω is the circular frequency, and k is the wavenumber. This attenuation is exactly why the instrument is restricted to measuring longer waves at deeper instrument locations. It is impossible to measure high frequency waves of low amplitudes from instruments deployed at large depths.

Cutoff and Extrapolation

A matter that must be taken into consideration when using spectral analysis to estimate wave statistics is that, as we move up in frequency there will be a point where there is no response in the signal, yet the attenuation continues to become more significant. This weakening, or attenuation, increases with frequency. At some cutoff frequency, the velocity and pressure signal becomes so weak that the waves can no longer be detected.

The problem arises when the perturbation is less than the sensitivity of the sensor. This leads to a false growth with the spectral level as we increase frequency (as illustrated in the figure below). The end result is that the calculated surface spectrum "blows up" into infinity. The reason for this false growth is that as we move up in frequency, the signal drops into the noise floor while the transfer function decays exponentially. Therefore, at some frequency in the spectrum a minimum must be chosen before it grows without bound.

This behavior at high frequencies necessitates the need for defining a cutoff frequency and an extrapolation from this frequency onward. Since we will ultimately integrate the spectra for the momentum calculations, we require spectra that are unambiguous and bounded. We assume that the spectrum follows a Pierson-Moskowitz or JONSWAP type spectrum. This is an empirical spectral shape, where the tail rolls off at a rate of $f^{-4.5}$.

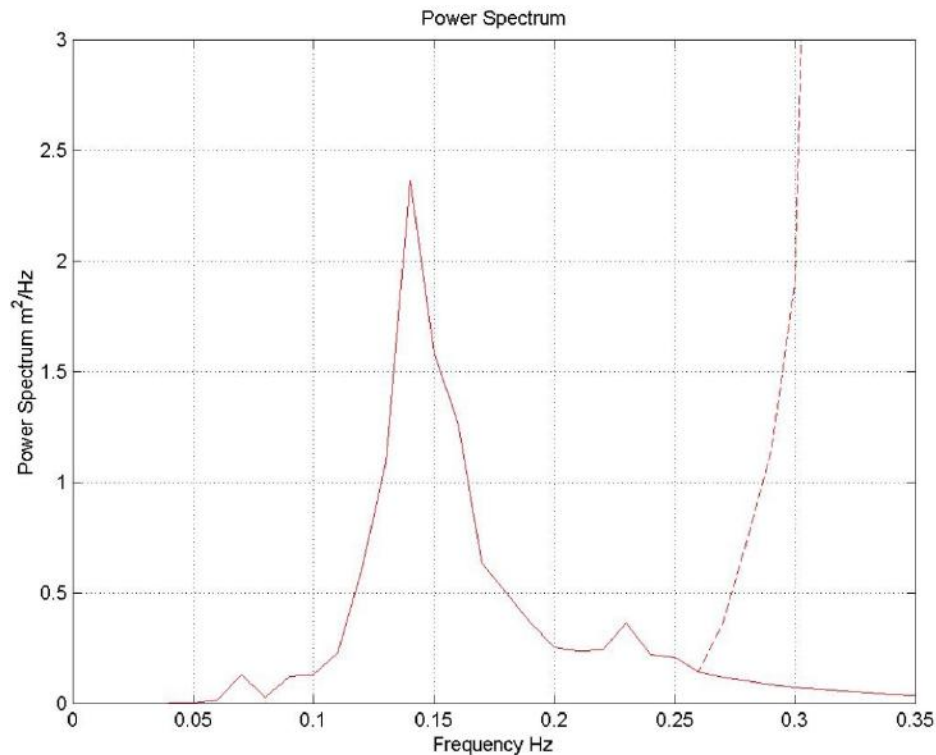

Figure: Example of high frequency extrapolation. Note that the original signal is represented by the dashed line. The figure is reprinted from [2].

The frequency at which the cutoff is selected is determined by finding the last local minimum above a maximum amplification factor in the spectrum as we sweep up in frequency. The problem with a sensor cutoff leaves the possibility of not detecting wave energy about the cutoff, and this lead to errors in some wave estimates (Hm0, Tm02) if no extrapolation is done. The AST has no extrapolation applied to it because it does not have a cutoff frequency limitation like the pressure or velocity based estimates. This is because AST is a direct measurement of the surface, and transfer functions are not used.

AST technology

Pedersen, T., Lohrmann, A., 2004: [Possibilities and limitations of Acoustic Surface Tracking](#)

PUV waves

Nortek AS Technical Note, Wave Measurements Using the PUV Method, (TN019), 2002: [PUV Wave Measurements](#)

SUV waves

Pedersen, T., Lohrmann, A., Krogstad, H., 2005: [Wave Measurements from a Subsurface Platform](#)

Pedersen, T. Siegel, E., 2008: [Wave Measurements from a Subsurface Buoy](#)

Pedersen, T., Horn, K., Wickström, K., 2009: [Subsurface Wave Measurements Taken to New Depths](#)

Service Manual

SECTION

3

3 Service Manual

This section covers

- ✓ Tests that should be performed to ensure that the instrument works as expected
- ✓ Verification procedures
- ✓ Steps to follow when working inside the instrument

This manual covers guidance and tips when working inside the instrument. It covers the Aquadopp, Aquadopp Profiler and AWAC instruments, which bear many similarities to each other.

It is important to note that when opening the instrument, great care should be taken to keep the sealing surfaces clean and protected from mechanical damage. Only qualified personnel should perform corrective maintenance activities. Please use this Service Manual as guidance and contact us for further assistance.

In this manual, you may encounter a couple of unfamiliar terms: Midlife and Pre-Midlife. The difference between the two is simply when the instrument was produced; Pre-Midlife are instruments produced before 2009. If you are unsure about what version you have, you can check the firmware version or send us an email with the serial number and we will check it out for you.

If your current firmware version number starts with 0.xx or 1.xx, your instrument is a so-called Pre-Midlife version. If your current firmware version starts with 2.xx or above, it is a Midlife.

3.1 Function Testing

Always test the instrument before a deployment to verify that it works as expected. The Final Test Checklist ([Appendix A](#)) has been used at the factory for years and is a quick but effective test that can be used as a template for the function testing of the system. Additionally, always make sure you have the most recent software and firmware installed. The most recent are always available on our web site.

3.1.1 Initial Test Setup

3.1.1.1 Power

The first step is to make sure the instrument has a source of power. Power will normally come from the internal battery pack or from the AC/DC converter that is delivered with most systems.

Internal batteries

The internal battery pack is located inside the pressure case for all instruments except AWACs. Internal batteries enable autonomous deployments of up to a year and also provide backup power in the event of failure of the external supply. Nortek alkaline battery packs use 18 AA cell batteries at a nominal starting voltage of 13.5 VDC. The voltage of alkaline batteries falls quickly at the beginning, slowly during most of its life, then again quickly at the end. Thus, a 13.5 VDC battery pack will spend most of its life somewhere in a voltage range of 10.5-12.5 VDC. Find more information about the Nortek Batteries at our [website](#).

Note that the battery pack inside the pressure case is disconnected when sent from Norway. Refer to [this section](#) for instructions on how to connect or change a battery pack. It also ships with an external power supply, which we recommend you use for all but the final testing. If you leave the instrument collecting data, it will continue to run until the batteries are dead. Always make sure to stop data collection when testing is complete.

External power

You may also supply power with the external supply that is delivered with the systems, or you can use your own external supply. If you use your own supply, be sure the voltage does not exceed 15 VDC for the Aquadopp/AquaPro or 18 VDC for the AWAC, and that it can supply 2-3 A. Check out the data sheet for your specific instrument for exact requirements.

If you use an internal battery to backup data collection, an external supply of 15 VDC provides a higher voltage than the battery pack, which prevents the internal pack from discharging. Then, if external power fails, the internal battery pack takes over and sustains operation.

The power and battery lines are diode protected, so you do not have to worry about wiring the instrument power backwards - this will not damage your instrument.

3.1.1.2 Converter

A compatible converter is included with all instruments. Currently there are two USB converters that are guaranteed to work with the instruments:

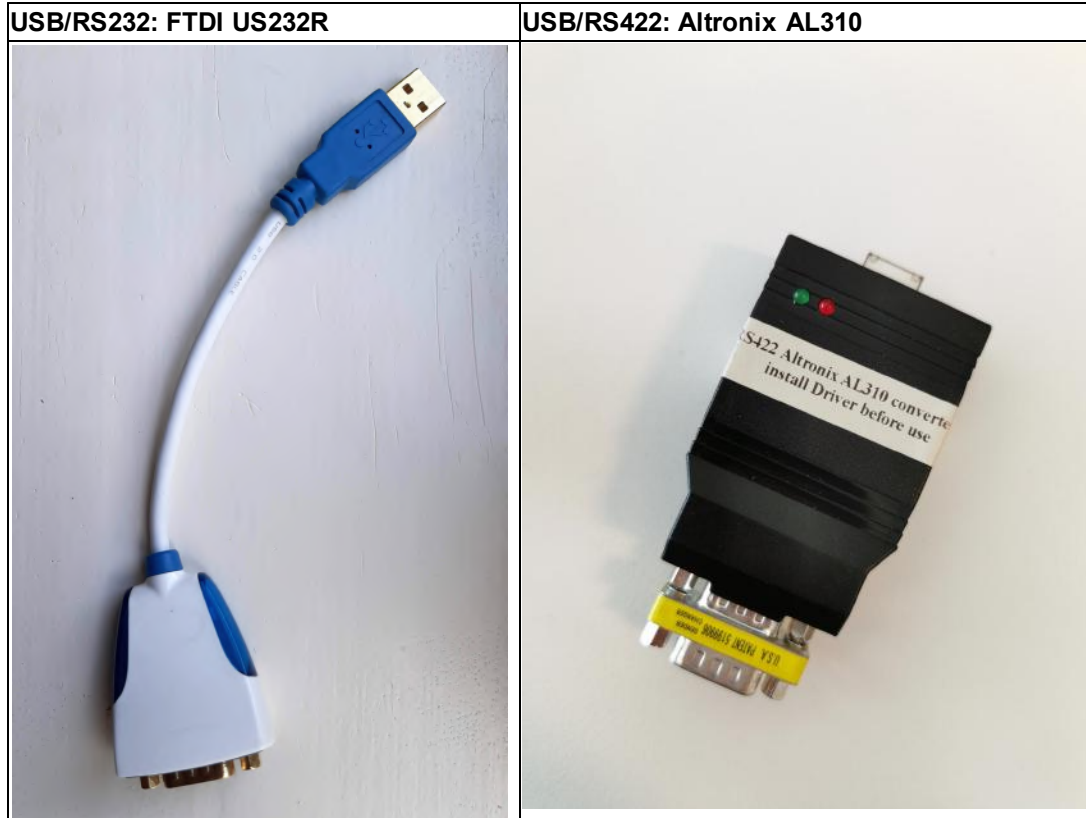

Connect the serial cable to the converter, and insert it into the USB drive of the computer. For first time use, give the converter enough time to install its driver correctly. If the driver is not installed correctly, find the updated versions from our software site.

3.1.1.3 Connect cables

Plug the appropriate ends into the instrument and to the computer via the converter, and make sure the computer connector does not easily fall out.

Before deployment: protect the cable connector by applying a thin layer of silicone lubricating spray to the pins before you plug it into the instrument. We recommend the 3M Silicone Spray.

Cable Wiring

The cables come standard with an 8-pin cable using either RS232 or RS422 communication, depending on what was chosen at the point of order. See tables describing the pin assignments for the 8-conductor RS232 cable with analog inputs and the 8-conductor cable with RS422 and sync in the [Cables and Wires](#) section. If you have a special cable, contact Support to get the correct information.

3.1.1.4 Start the appropriate software

Find the instrument specific software on the USB stick that came with the instrument, or download it from our Software and Firmware site (<https://www.nortekgroup.com/software>), and install it on your PC. Installing instrument software does not require a license key. After installation is done, start the software and proceed with the following:

1. Select Serial Port from the Communication menu to specify the port number to use. If you are unsure about which port number to use, check the Device Manager on your computer.
2. Baud rate: You are allowed to set two baud rates. The primary baud rate setting applies to normal communication and data transfer. The standard baud rate is 9600, and we recommend that you use this baud rate unless you have a good reason to change it. You can also set a separate baud rate for data download and firmware upgrades (the download/configuration baud rate). A higher baud rate speeds up large file transfers and is appropriate when you have a short serial cable and a relatively noise-free environment. To change the baud rate and make it permanent, do the following:
 - Connect the instrument to your computer.
 - Set the baud rate in "Communication", "Serial Port" to the baud rate you prefer. Start a deployment, and then stop it. The last step makes the new baud rate permanent. If you remove power and reapply it, the instrument will re-awake with the new baud rate. NOTE: If data download is interrupted, the instrument may be left with a baud rate setting other than the one used for normal communication. When the software tries to establish communication in such cases, it may spend a few moments searching for the current baud rate.
3. Check communication: Verify communication by clicking the "Check Communication" button. The software will automatically find the instrument and read its current setup parameters. Alternatively, select Communication > Terminal Emulator, and press "Send Break". The instrument should respond with a message similar to the screenshot below (information about the model of your instrument plus the firmware version number and the mode the instrument is in). If you get a string of garbage characters, try another baud rate setting. If the instrument fails to respond, the software can auto-connect to the instrument. Press Stop Data Collection and wait until the instrument has been found.

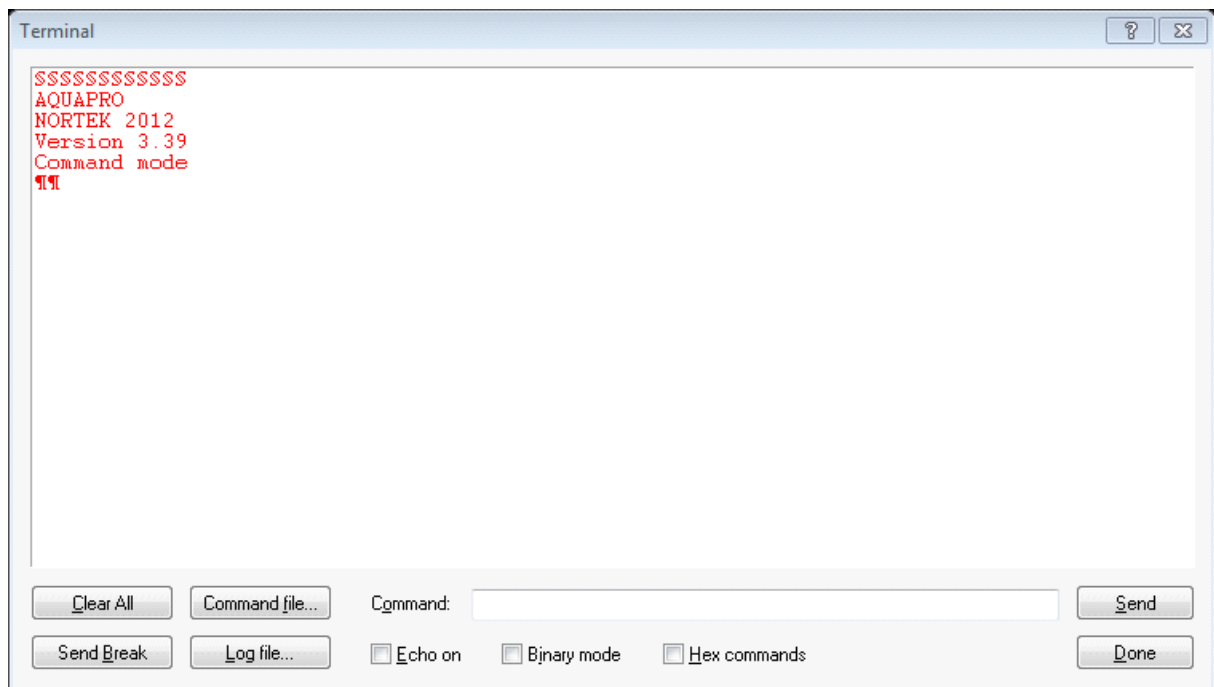

3.1.2 Sensor Checks

The first step when performing sensor checks is set the instrument to collect data every second. Find the Deployment planning dialog by clicking Deployment > Planning or the corresponding toolbar button.

Current profile	Instrument	Deployment planning
Profile interval (s): <input type="text" value="600"/>	Frequency: <input type="text" value="1 MHz"/>	Battery pack: <input type="text" value="Alkaline"/>
Number of cells: <input type="text" value="20"/>		Battery capacity (Wh): <input type="text" value="540"/>
Cell size (m): <input type="text" value="1"/>		Assumed duration (days): <input type="text" value="30"/>
<input checked="" type="checkbox"/> Waves	<input type="checkbox"/> Ice mode	Battery utilization (% of capacity): <input type="text" value="57"/>
Number of samples: <input type="text" value="1024"/>	<input type="checkbox"/> SUV mode (for sub-surface buoy)	Memory required (MB): <input type="text" value="18.5"/>
Sampling rate: <input type="text" value="1 Hz"/>		Vertical vel. prec. (cm/s): <input type="text" value="0.7"/>
Interval (s): <input type="text" value="3600"/>		Horizont. vel. prec. (cm/s): <input type="text" value="2.2"/>
Estimated depth (m): <input type="text" value="20"/>		Compass update rate (s): <input type="text" value="600"/>
<input type="checkbox"/> Use Advanced Settings	<input type="checkbox"/> Use Hardware Settings	Power level: <input type="text" value="HIGH"/>

Figure: AWAC AST Deployment planning dialog, Standard tab

- For profiling instruments; set Profiling interval = 1 sec,
- For current meters; set Measurement interval = 1 sec,

Start the test deployment by clicking On-line -> Start Data Collection or click the Start Data Collection toolbar button.

You can find a checklist template for the function testing of the system in Appendix A.

3.1.2.1 Temperature

Confirm that the temperature reading is realistic. The temperature reading should be close to your room temperature, assuming the instrument has been in the room for a while to allow for the long time constant. The temperature sensor is located inside the sensor head for most instruments, for the AWAC it can be visible from the outside.

Specifications:

- Range: -4°C to 40°C
- Accuracy/Resolution: 0.1°C/0.01°C
- Time response: 10 min

3.1.2.2 Tilt

The tilt sensor is located on the electronic boards inside the housing. The tilt sensor orientation is set in accordance with the system orientation during normal operation. The standard instrument is designed for vertical orientation. The tilt sensor can be inverted 180 degrees - that means you can use it pointing up or down. Tilt sensors in heads designed for horizontal orientations will be mounted at right angles. A tilt sensor that is installed for vertical orientation will be unusable in a horizontal orientation, and vice versa.

- 1) Click the Sensors tab on the main screen of the software
- 2) Hold the instrument as level as possible to check that the tilt reading is close to zero
- 3) Find the X-marking on the head and point it away from you
- 4) Tilt the instrument to about 10 degrees to the right, and verify that the roll reading has a positive sign, and that the value is around 10 degrees
- 5) Tilt the instrument to about 10 degrees to the left, and verify that the roll reading has a negative sign, and that the value is around 10 degrees
- 6) Tilt the instrument about 10 degrees forward, and verify that the pitch reading has a negative sign, and that the value is around 10 degrees
- 7) Tilt the instrument about 10 degrees backward, and verify that the pitch reading has a positive sign, and that the value is around 10 degrees
- 8) Turn the instrument upside down, confirming that the last status bit changes from 0 to 1 to indicate a change in up/down orientation, and perform steps 2-7 again

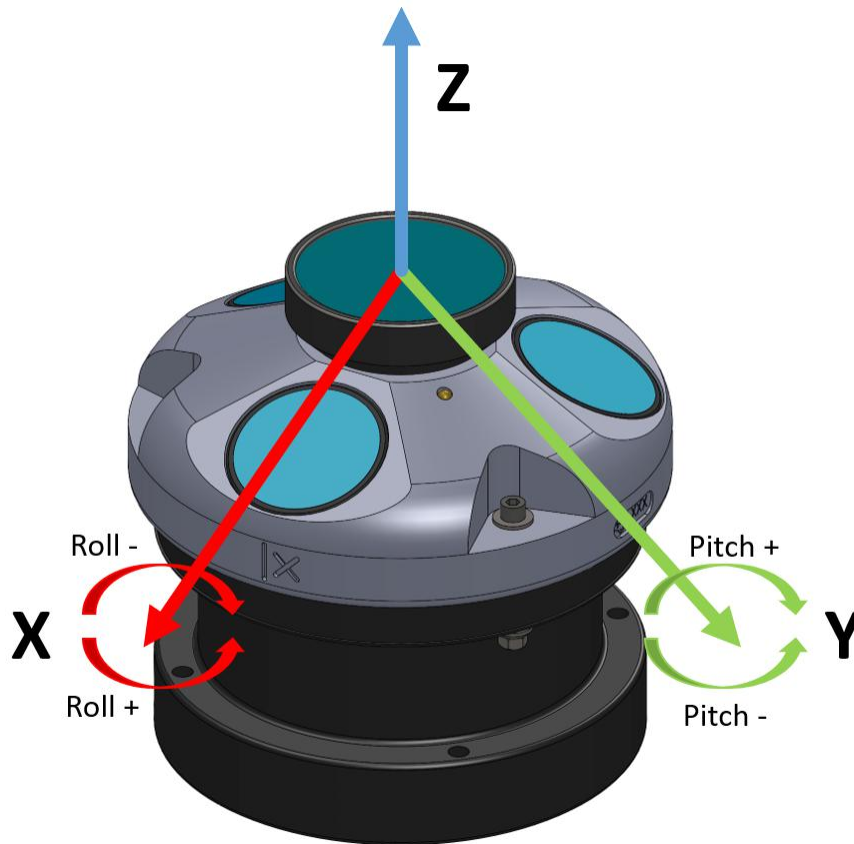

Specifications:

- Accuracy/Resolution: 0.2°/0.1°

3.1.2.3 Compass

The compass measures the earth's magnetic field. Combined with the tilt sensor on the head, the compass enables the instrument to obtain heading information. These data enables the instrument to convert velocity measurements to Earth coordinates. Without a compass, the instrument still measures the tilt.

To test the compass: Hold the instrument away from any magnetic influence (like metal objects, cell phones etc.), slowly rotate it in different directions, and verify that the heading readings are sensible.

Remember to perform a [Compass Calibration](#) before deployment. See also "How To" videos on Nortek Support site.

3.1.2.4 Pressure

Have in mind that the pressure sensor is not a depth meter. Due to atmospheric pressure variations, the sensor signal may have an offset. Note that the sensor does not output negative values.

- 1) Set the pressure sensor depth to 0.2 m in the On-line > Set Pressure Offset dialog.
- 2) Place the instrument in a suitable container filled with water (approximately 0.5 m deep)

- 3) Verify that the pressure reading is correct; with the instrument submerged to 0.5 m, and with an offset of 0.2 m, the pressure sensor should read 0.7 m.

Remember to perform a [Pressure Offset](#) before deployment. See also "How To" videos on Nortek Support site.

3.1.3 Noise floor and Pinging Checks

First, check the noise level of the instrument. See the readings in the software, under the Current tab. Pinging in air should produce signal strengths (amplitudes) of 20-30 counts.

When the instrument pings in air, the velocity measurements will be nothing but noise. The signal values above are therefore referred to as the noise floor. Data from all beams should show a similar noise floor. Note that the Deep Water versions (titanium housings) of the instruments are prone to noise in human environments, so you may see a higher noise floor than the above listed. This will not be a problem in the field/in water.

Put the instrument in a bucket of water and observe the signal strength and the velocity. The signal strength should rise noticeably (the actual level depends on the size, shape and material of the bucket), and the velocity data should appear less noisy.

To get everything right before deployment, you may want to verify that your Nortek instrument actually emits pings. This can be done by utilizing a simple AM radio:

- 1) Adjust the radio to the frequency of your Nortek instrument, i.e. for a 1MHz Aquadopp adjust the radio to 1MHz, for a 600kHz system adjust it to 600kHz, etc.
- 2) Start the Nortek instrument and hold the radio close to the transducers. What you now hear is the pings themselves (they sound like a busy woodpecker).
- 3) Stop the test by clicking On-line -> Stop Data Collection or press the Stop Data Collection button.

COUNTS - A few words on the term

For signal strength, Nortek frequently make use of the word counts, which obviously seem to be connected to the decibel term, but how and why? Inside the instruments there is circuitry for the amplification of input signals, the number of counts is an indicator of how much gain we must apply to a signal - the less gain needed, the higher the input signal level is. The number of counts is inversely proportional to the logarithm of the gain setting, which means that a higher number of counts reflects a need for less amplification than a lower number of counts will do. Strong signals have a higher noise immunity and they correlate much better than weak signals do. The scaling for the conversion from counts to dB varies a little from one instrument to another, but 1 count is around 0.4-0.45 dB. For more details check out Technical Note 003: Monitoring Sediment Concentration with Acoustic Backscattering Instruments, available at the [Nortek Support site](#).

3.1.4 Beam Amplitude and Velocity Checks

The following checks should be carried out in a suitable stretch of unobstructed water. We recommend carrying out initial testing in a test tank, which is both convenient and provides a controlled environment. If there are insufficient scatters in the water, some seeding material may be necessary. After the tank test, a final testing can be carried out in open water, such as in a lake, river or the sea. Nortek can provide further details on suitable test arrangements on request.

3.1.4.1 Amplitude

- 1) Change the coordinate system to Beam Coordinates by choosing Beam as Coordinate system in the Advanced Deployment Planning menu. Note that the “Used Advanced Settings” box in the Standard view must be checked for the Advanced view to become accessible.
- 2) Start the test deployment by clicking Online > Start Data Collection or click the corresponding toolbar button.
- 3) Click the Amplitude or Profile tab to observe the amplitude of all the beams on the graphic display.
- 4) Test the amplitude of each beam. Either:
 - Immerse the instrument so that all the transducers are submerged. Point each beam in turn with an angle from the horizontal (relative to the transducers) and away from any obstructions, or;
 - Fill a bag or rubber glove with water and hold it over each beam in turn.
- 5) Note the amplitude of each beam as it points into water unobstructed, displayed in counts. All the beams should have similar amplitude, within 10 counts of each other. When testing a profiling instrument, the beams should be compared in the same cell, normally the first one.

As an additional check, each beam can be blocked in turn, by either holding each transducer out of the water (while keeping the others immersed) or by covering each transducer with a suitable acoustic attenuating material such as dense plastic, or even a finger. The amplitude of the blocked beam will fall to around the noise level, while the others will remain unaffected.

3.1.4.2 Velocity

- 1) Change the coordinate system to XYZ by selecting XYZ as Coordinate system in the Advanced Deployment Planning menu.
- 2) Start the test deployment by clicking Online > Start Data Collection or click the corresponding menu button.
- 3) Click the Velocity tab to observe the X, Y and Z velocities on the graphic display.
- 4) Move the instrument backwards and forwards at a constant velocity through the water, along the X-axis. A positive and negative deflection of the X-axis velocity should be observed on the graphic display, while the Y- and Z-axis velocities should remain around 0 m/s. Repeat the procedure for the Y- and Z-axis. Ensure that the displayed velocities are reasonable.

Read more about coordinate systems in the Principles of Operation, where you will find Beam, XYZ, and ENU definitions. Note that the X-axis engraved or clarified in form of a colored indicator on the head/probe of the instrument always points in the direction of a positive X-axis. For many instruments this coincides with Beam 1, but not always.



Figure: AWAC definition of X-axis. Note the engraved marking on the AWAC head. For both the X-axis is pointing towards us.

3.1.4.3 Range Check (Aquadopp and Aquadopp DW)

Click On-line > Start Range Check to enter the range check mode. Point one beam at a time towards a boundary that is at a known distance from the transducer, and confirm that the amplitude graph shows a kink at the correct range reading. In the figure below, Beam 3 points toward a flume wall 0.7 m from the transducer.

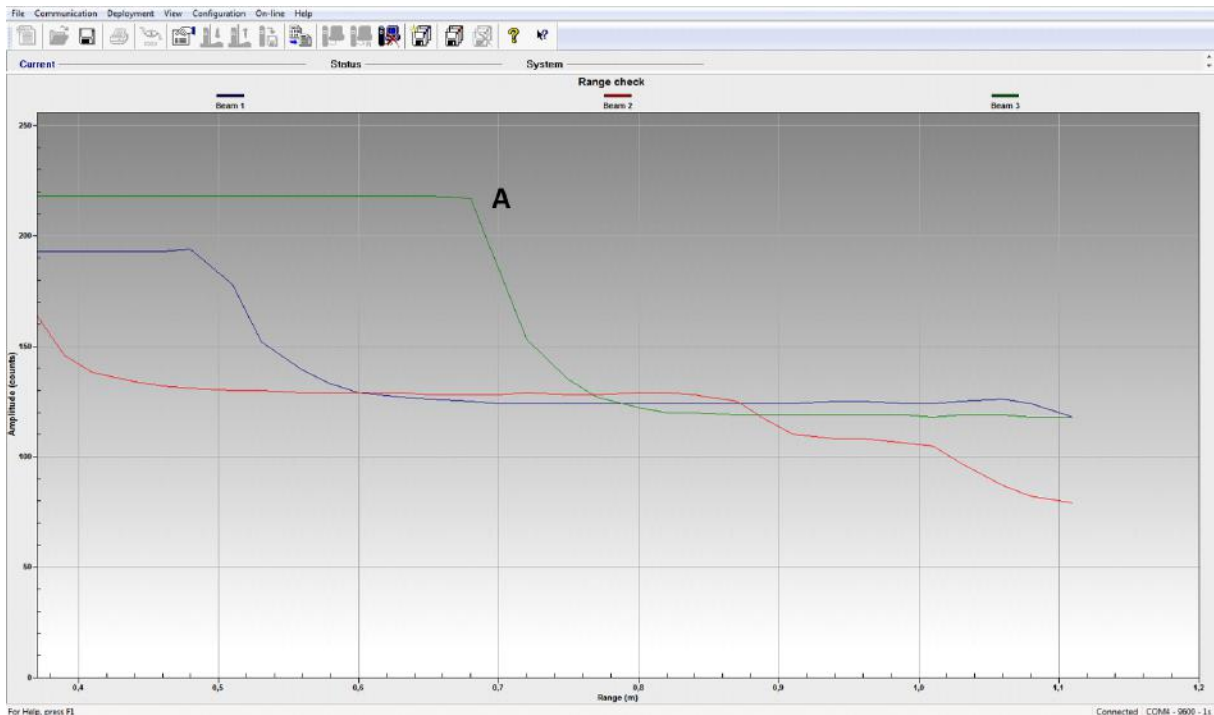

Figure: The kink in the amplitude graph of Beam 3 (A) tells us that the flume wall is 0.7 m away from the transducer.

3.1.5 Test Recorder Function

You can test the recorder with the same set-up as the above.

- 1) Start data collection with "Test" followed by "Start With Recorder".
- 2) Write a name to use for the file you will record internally.

- 3) After a few minutes, stop the data collection.
- 4) Retrieve your data by clicking "Deployment" followed by "Retrieve Data".
- 5) Convert it to ASCII by clicking "Deployment" followed by "Data Conversion".
- 6) Review the collected data with an ASCII text editor (i.e. Notepad).

If you leave the instrument collecting data, it will continue to run until the batteries are dead. Always make sure to stop data collection when testing is complete.

It is a good routine always to start a new deployment with an empty memory. Before you erase the recorder, make sure that you have transferred all the data you want to retain to your computer and that the data is in good shape. Then click Deployment > Erase Recorder.

Note: The maximum number of files that can be stored in the File Allocation Table (FAT) is 31 on all Nortek instruments. The syslog takes one spot, so the maximum number of files with measurements is 30.

3.1.6 Battery degaussing

All fasteners and hardware are non-magnetic and the magnetic signature of the internal electric components is low. The exception is the alkaline battery pack. Therefore we recommend degaussing batteries before you use them.

The compass calibration will compensate for magnetic masses whose field strength and orientation relative to the compass do not change. The procedure can compensate for unchanging magnetic masses, but if the field produced by a mass close to the compass changes significantly over the course of the deployment, e.g. a discharging battery, heading errors may be the result.

There is no need to degauss lithium batteries.

3.2 Customer Calibration

All instruments have what we call a head matrix, which is unique to each instrument; it describes the geometry of the sensor head, or the transducer orientation to be more specific. As long as the sensor heads are not physically deformed, the head matrices will, consequently, remain the same. Further, what is measured by the sensor is the change in frequency from the acoustic pulses sent out through the water to those being reflected back. In other words, a slight change in center frequency will not affect the measured frequency shift, or the Doppler shift, which is entirely depending on the velocity of particles in the water. Therefore the sensors really never need to be calibrated for current speed and direction.

3.2.1 Compass Calibration

Each compass has been calibrated at the factory to quantify the characteristic response of the individual components and of the system as a whole. When it leaves the factory, each system can measure its tilt and the direction of its magnetic field vector accurately, anywhere in the world. However, users disturb the magnetic field near the instrument when they deploy. Adding a battery pack and mounting the instrument with deployment hardware adds magnetic materials that change the earth's field at the instrument. The compass calibration procedure quantifies this magnetic disturbance, and the instrument's compass algorithm then corrects for it to obtain accurate heading. Note that the calibration does not account for magnetic declination, but this can be added in post-processing.

As a side note, the compass is not used when measuring velocity in XYZ or beam coordinates, but if you plan on using the compass heading at a later point (for instance to orient the XYZ velocities relative to the lake axes) it is probably worth calibrating the compass in advance.

You should perform the compass calibration just prior to deployment to correct for the introduction of new magnetic materials, as you can correct for magnetic sources that rotate in the same coordinate system as the compass itself. The compass calibration procedure requires a single, slow rotation around the instrument's tilt axis. A rotation taking at least 60 seconds is sufficient. For the calibration procedure to work, the compass and all magnetic materials must remain fixed relative to each other. As long as this is the case, the calibration procedure can correct for magnetic field disturbances that are greater than the earth's magnetic field. You should conduct this procedure outdoors, away from other possible magnetic elements.

Checking the 'Transformation with pitch and roll' box will compensate for tilt while the instrument is being rotated. Without this checked, you have to be very careful to keep the instrument level, which can be very difficult.

- 1) Assemble the frame (or similar) with the instrument, battery canister, and extra ballast, etc. and connect the system to the computer.
- 2) Make sure the frame is level when calibrating the compass, and that it is possible to rotate the entire system 360° horizontally.
- 3) Click On-line > Compass Calibration.
- 4) Click Start and rotate the entire system slowly around the Z-axis of the instrument. An example of a successful rotation is shown below. Note that when doing this in the field, you cannot expect to end up with a circle as perfect as this one. However, we recommend you to do this slowly in an attempt to come as close to the ideal circle as possible.
- 5) You need to decide whether the estimated maximum error is acceptable for your deployment. As a general rule of thumb, we suggest that $\leq 2^\circ$ denotes a good compass calibration.
- 6) To utilize the obtained values, click Done. You will be prompted to confirm that the new values shall be transferred to the instrument to serve as the new compass setting.

Typically you will see offsets coming from these two sources:

Hard Iron (X/Y offset): This will cause a shift in the position of the ellipse away from the origin (0,0).

Soft Iron (Mx, My, Mz): This will deform the ellipse.

After the instrument offsets have been updated the calibration can be verified by re-executing the data collection and rotation and ensuring that the circle produced is centered on (0, 0, 0) (and that the

corresponding offset corrections are close to 0). This will verify that the hard and soft iron influences have been compensated for.

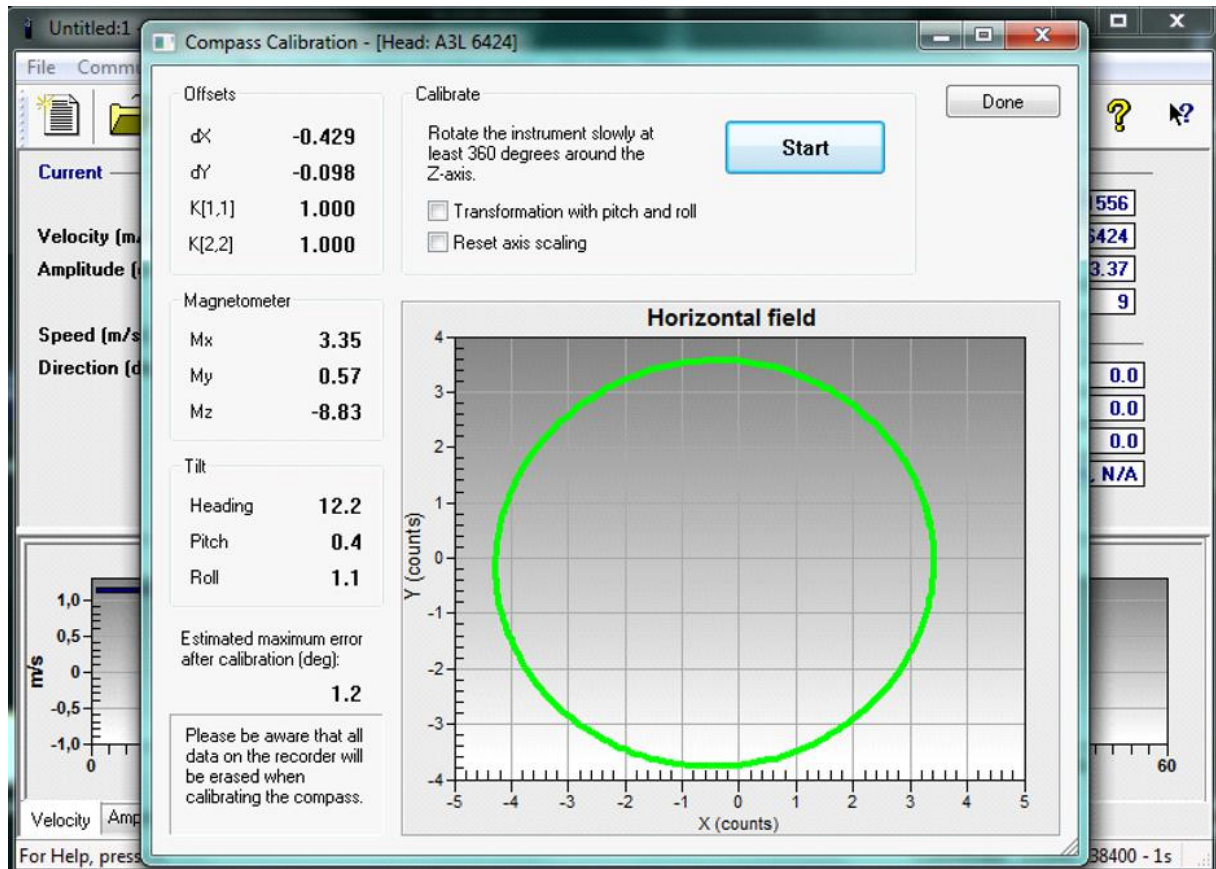

Figure: Successful rotation of a compass calibration.

3.2.2 Pressure Offset

The pressure sensor offset is not calibrated to, or corrected by, the atmospheric pressure. This means that the pressure sensor reading will follow the atmospheric pressure, thus the sensor signal may have an offset. Atmospheric changes can vary the depth reading as much as 0.3 m. Note that all data on the recorder will be erased during this procedure.

To set the Pressure Offset:

- 1) Connect the instrument to a computer and submerge the instrument to a known depth.
- 2) Click Online > Set Pressure Offset and key in the depth in meters. The below figure shows the dialogue box for setting the pressure offset.
- 3) When the pressure has a stable reading, as in the screenshot below, click Done.

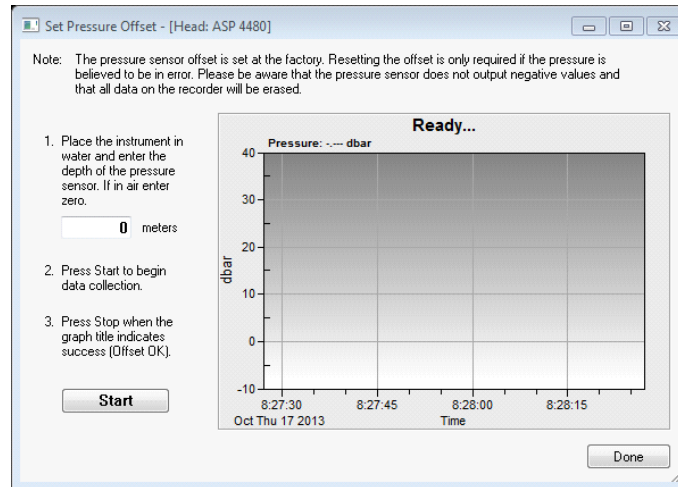

Figure: Set Pressure Offset dialog

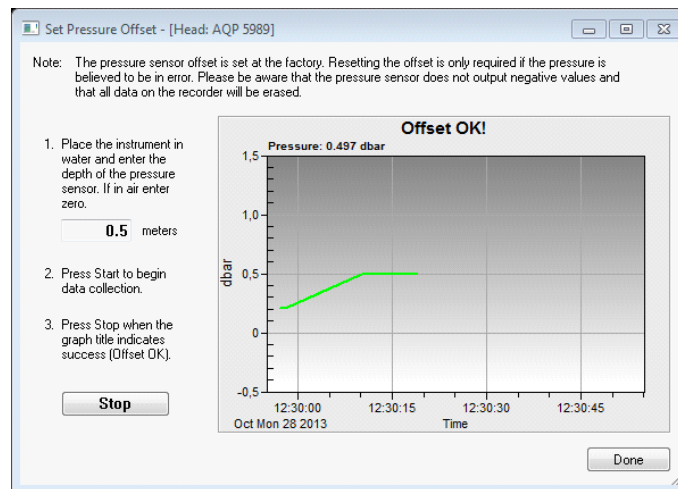

Figure: Stable pressure reading and the title indicates success

3.3 Changing a Battery Pack

Because the battery pack uses standard alkaline batteries, you normally do not need to observe any special precautions and/or procedures when you dispose old batteries.

When opening the instrument, great care should be taken to keep the sealing surfaces clean and protected from mechanical damage.



Caution!

If you have lithium batteries, keep in mind that you must be very careful and that disposal requires special precautions and/or procedures. Rules for disposal of batteries, especially lithium batteries, vary from country to country.

A fresh desiccant bag should be included in the pressure case, as humid air can condense enough water do damage the electrical circuitry.



3.3.1 Aquadopp and AquaPro

The following procedure outlines how to connect the battery or to install a new one.

A. Remove the four #6-32 x 3/4" titanium screws and washers holding the end cap to the pressure case and remove the endbell.	
B. Disconnect the 2-pin connector and pull the battery out of the pressure case.	
C. Insert the new battery into the pressure case and reattach the 2-pin connector.	
D. Reattach the endbell to the pressure case and mount with four titanium bolts and washers. Make sure that there are no dust or particles on the O-rings on the endbell, and that they are whole. See Recommended torque when securing screws - you do not need to fasten them too much	
E. Test the instrument by collecting data without using an external power source to ensure that the battery is properly connected. Make sure to stop data collection so that the instrument will power down after you are through testing it.	

3.3.2 AWAC and Continental

The AWAC and Continental are normally shipped with a separate battery canister. The following procedure outlines how to connect the battery pack or to install a new one.

A. Remove the three screws and washers holding the end cap to the pressure case, and remove the end cap.	
B. Disconnect the 2-pin connector and pull the old battery out of the pressure case.	

C. Slide in a new battery and connect it to the 2-pin connector to the end cap.	
D. Insert the end cap to the pressure case and mount the three screws and washers.	
E. Test the instrument by collecting data without using an external power source to ensure that the battery is properly connected. Make sure to stop data collection so that the instrument will power down after you are through testing it.	

3.4 Upgrade Firmware

By the term firmware we are referring to the internal software of the instrument, as opposed to the instrument software running on a PC. When you purchase a brand new instrument, it has a firmware version matching the PC software, hence no firmware upgrade will be needed before you start using the instrument. However, new functionality (and in rare cases bug fixes) is likely to be offered in the future, requiring that the firmware is upgraded. New firmware is posted at the Nortek web, at <https://www.nortekgroup.com/software>. You will need to register to get access, but access is otherwise free of charge. Transfer data that you would like to retain to your PC before you upgrade the firmware, as any data recorded on the instrument will be erased to avoid inconsistencies.

To do the upgrade:

- Download the firmware that applies to your instrument.
- Connect the instrument to a PC.
- In the instrument software, select Configuration > Firmware Upgrade.
- Browse and select the new firmware file and click "Open".

If you are asked for a license key, you can find it on the flash disk that accompanied your instrument. If you cannot locate it, contact Nortek for a new key.

3.4.1 AquaPro HR to AquaPro

If you have an AquaPro HR, you can change it to an AquaPro by upgrading the firmware, and vice versa.

- Connect the instrument to a PC.
- If you have HR firmware and want to use the instrument as an AquaPro for a period, you must use the AquaPro software (not HR), and do a firmware upgrade according to Section 1.5.2. The AquaPro software can be downloaded from [our website](#).
- If you want to re-install HR, use the AquaPro HR software. When asked for a license key, use the one you retrieved with the instrument. If misplaced, [contact Nortek](#).

3.5 Erase Recorder

- Connect the instrument to a PC.
- In the instrument software, select Deployment -> Erase Recorder.

Recorder wear may occur when a large number of write/erase operations are issued. The exact number may vary between instruments but is specified to 10,000 files. This means if the recorder is erased each time then 10,000 deployments can be done before having to replace the recorder.

The flash circuit on the main PCB is closely linked to the recorder. Read [here](#) for more information.

3.6 Mechanical Aspects and Maintenance

Preventive maintenance is your primary tool to keep your instrument in shape and ready for action and deployment. We recommend a regularly scheduled procedure which will act as a preventative measure to ensure your instrument continues functioning as intended. The following sections can be used as a maintenance guideline for the components that may be exposed to wear and tear.

We recommend conducting a Functionality Test after the maintenance procedure has been finished, to ensure that the instruments functionality is as expected. For AD2CP instruments, we also recommend adding an entry in the internal log that is kept within the instrument. This can be helpful in assessing service intervals etc. The "Add Deployment Log Entry" box on the Logs tab in the web interface can be used for this. This log will also keep a record of things like formatting or erasing the recorder and firmware upgrades.

DO NOT EXPOSE THE ELECTRONICS

In general, there should be no reason to expose the instrument electronics. **Do not open the housing to expose the electronics unless instructed by Nortek.**

Only qualified personnel are allowed to perform corrective maintenance activities. Please [contact Nortek](#) for further assistance if in any doubt.

3.6.1 Instrument Care

All Nortek instruments are intended for use in water. Other fluids may have an adverse effect on the materials used.

For prolonged storage at elevated temperatures close to the specified limit, or when temperature variation is uncertain, it is recommended that the screws securing the end cap be loosened in order to minimize the risk of any deformation due to temperature/stress over time (if your instrument has an accessible pressure case).

A preventive maintenance routine should include regular cleaning of the instrument. Use a **mild** detergent and pay special attention to the transducers. Do not expose any part of the instrument to harsh chemicals. Check the pressure sensor and remove any dirt from the holes in the cap. Be careful when opening the pressure sensor cap as it is easy to dent the sensor.

Do not use the molded head or endbell as a clamping surface, always clamp to the instrument housing.

When opening the instrument, great care should be taken to keep the sealing surfaces clean and protected from mechanical damage. Keep water out of the open pressure case. Both fresh and salt water can corrode the circuitry.

If the instrument has been subjected to environmental conditions outside the specified design limits (refer to the [Technical Specification](#) for your instrument for the limits), mechanical tolerances of non-metal components may be affected.

3.6.2 Connector Care

It is extremely important to keep connectors clean and well lubricated. Before plugging in connectors we recommend to always blast the pins with compressed air, inspect them for cleanliness and then protect the cable connector by applying a thin layer of silicone lubricating spray on the pins before you plug it into the instrument. We recommend the 3M Silicone Spray. Do not use the silicone grease included in the toolkit on connectors, as this is intended for O-rings only.

Before deployment:

- Demate the connector set.
- Flush both halves of the connector set with compressed air and remove any dirt.
- Check that both connectors are dry. If not, let them air-dry.
- Inspect for damage, corrosion and cuts.
- Apply a thin film of 3M Silicone Spray or equivalent.
- Mate the connector halves, and mate any unused connectors with dummy plugs. Ensure the rubber part of the female connector is properly seated over the pins before screwing on the locking sleeve.

After deployment and before storage:

- Flush both halves of the connector set with compressed air and remove any dirt.
- Check that both connectors are dry. If not, let them air-dry.
- Inspect for damage, corrosion and cuts.
- Mate with a dummy plug.

3.6.3 Cable Care

To keep your cables in good condition:

- Avoid nicks and cuts around contacts, as these are the sealing surfaces.
- Do not pull on the cable to disconnect connectors; pull the connector itself.
- Avoid sharp bends at cable entry to connector.
- Ensure that the cable is fixed to the mounting fixture to avoid mechanical stress to the connection.
- Elastomers can be seriously degraded if exposed to direct sunlight or high ozone levels for extended periods.

3.6.4 Replace Desiccant Bag

Humid air can condense enough water do damage the electrical circuitry. At least once a year, replace the desiccant located in the pressure case or the external battery canister. You may wish to replace the desiccant bag more regularly if the instrument is exposed to multiple significant changes in temperature (e.g. from a hot/humid surface environment to cool water). Refer to the battery installation procedure for your instrument for instructions on opening the pressure case.

3.6.5 O-ring Care

O-rings are the critical component that keeps water out of the housing and thus the instrument dry. Watertight sealing of the instrument housing is provided by double O-rings on the head and end cap sub-assemblies. The outer O-ring forms the primary seal and the inner forms a secondary (or backup) seal. If the integrity of the O-rings are degraded the instrument should not be re-deployed. In this case, [please contact us](#).

If the instrument has never been opened, O-ring inspection is not necessary. However, when changing batteries, the O-rings on the endbell are exposed. Make a routine of inspection, maintenance and replacement of exposed O-rings.

- Check the O-rings and the O-ring grooves for grit, hair, lint, sand, or anything that could potentially breach the O-ring seal.
- After frequent deployments or if O-rings or grooves appear dirty, remove O-rings and clean the grooves. To remove O-rings, use finger pressure or the rounded edge of a plastic card to lift the O-ring out of the groove. Caution! Never use a metal object to remove an O-ring. It may cause damage to the O-ring or the sealing surface.
- To check O-rings for damage, place the O-ring between the middle and index finger and thumb. Then pull the O-ring through your fingers, feeling for any debris or wear.
- If O-rings are dirty, it is best to replace them. Washing dirty O-rings with soap and water is not recommended. Soap breaks down the lubricants and will compromise the integrity of the seal.
- Properly greased O-rings will help maintain sealing integrity and minimize O-ring degradation. Use enough grease to lubricate the O-ring thoroughly, but not so much that it will attract additional debris.
- Clean the groove with a lint free swab or the folded edge of a paper towel.

NOTE: Do not open the transducer end on your instrument to check O-rings. Opening the whole instrument means exposing the electronics, and this shall not be done unless Nortek has approved and provided guidance on how to do it.

3.6.6 Securing Screws

When installing end caps and sensor heads, care should be taken when tightening the screws. Just a little tension on the screw is needed; when the O-ring starts to be compressed, turn each screw a little at a time until the O-ring is fully compressed.

Tightening one screw fully before continuing on to the next may cause improper O-ring seating and very high mechanical stress concentrated around the screw hole. This may cause leaks and/or damage to the head or the endbell. The screws need only be tightened sufficiently for the O-ring and spring washers to be fully compressed. Instead, use the cross tightening sequence: tighten one screw slightly, then move to the screw opposite. Tighten that one slightly, then change to the next pair of opposing screws and repeat. Continue in this pattern until the screws are sufficiently tightened.

Over-torquing has no positive effect and may damage the threads and/or area around the screw holes on the head and end cap. Keep in mind that ocean pressure holds the end cap tightly; all the screws have to do is to secure the end cap from falling out when the system is above water.



Figure: a) "Two-fingers" tightening of screws. Indicator arrow shows position before final tightening. b) Final tightening 30-45 degrees from "two-fingers" tightening.

3.6.7 Biofouling

Marine growth, or fouling, on moorings should be considered when planning long-term mooring systems. Current profilers used in long term monitoring projects will be covered with biological material. Eventually, the growth can become strong enough that the transducers are blocked and the profiling range is reduced. To know when to maintain the instrument it is best to monitor the long term variation in the amplitude data. This parameter varies with short time scales (depending on suspended sediment concentration, zoo plankton, bubbles, etc.), but biological growth (especially barnacles) adds a long term downward trend that can be monitored. The profiling range gradually goes down as the growth on the sensor increases. At some point, the signal strength will be too low to achieve the desired profiling range. Through experience you will gain knowledge about how long it takes before the transducers are covered and this information can later be used to set regular maintenance intervals where the transducers are cleaned.

When the instrument leaves the factory, the surfaces are quite smooth and it will take some time before any growth starts. After the first cleaning, the surface is rougher and it becomes easier for new material to grow. Typical maintenance intervals are 6-12 months, but the growth rates vary a lot with the geographical location, water temperature, season, and deployment depth. In general, heavy growth is seen in hot and shallow areas. Cold and deep water areas see very little growth so maintenance can be less frequent.

When calculating forces, the marine growth is accounted for by increasing the expected weight and diameters of the mooring line and all instrumentation attached, in addition to increasing the drag.

Antifouling paints and other agents are often used to avoid transducers being covered with barnacles or other evil crustaceans during long deployments. The important thing when it comes to antifouling is that the paint is not too thick, otherwise the signal strength may be affected. Nortek has tested the effect of antifouling paints on the profiling range of the 2 MHz Aquadopp and no appreciable change was found when a thin (1 mm or so) layer on the transducers was applied. You can probably use most anti-fouling paints as long as it is not too (chemically) aggressive and contains no solids (metal flakes, etc.) that could interfere with acoustic beams. Anodes and pressure ports should not be painted.

Nortek has run a test with three different zinc oxides, a zinc paste with 40% zinc oxide, Silulen (Nycomed) with 20% zinc oxide and Desitin (Pfizer) 40% zinc oxide. They all work quite well but the Silulen a little less so. Our conclusion from the test was that a higher zinc oxide percentage is probably better. Other options are use of thin plastic bag or Pettit's Trinidad anti-fouling paint (75.8% cuprous oxide). A different approach is to use an anti-fouling adhesive patch that covers each transducer. These



patches have doubled deployment lengths in warm, biologically-active waters by keeping the transducers clear for longer and greatly increasing the required maintenance interval to remove biofouling. They have no detrimental effect on the quality of the measurements from covered transducers. Contact your local Nortek representative for more information.

We realize barnacles have to be removed mechanically, but we strongly advice against using sharp objects capable of harming the polyurethane surface. We also recommend staying away from strong organic solvents such as acetone. A common, easy, and inexpensive way to keep the Delrin housing on the Aquadopp and Aquadopp Profiler clean is to wrap the housing in either clear packaging tape and/or clear plastic wrap (such as the brand name "Saran Wrap"). At the end of the deployment, simply unwrap the protective coating to find a clear instrument. Tapes such as "Duct Tape" can leave a sticky residue that is very difficult to remove (although it does not actually harm the Delrin housing).



3.7 Cables and Wires

This chapter gives you the wiring for the most common cables. The wiring is the same if the connector is circular or square. In addition there is a table below describing the harness and the 24 pin connector at the electronics board. This might be handy if there is need to change the wiring harness without time to receive one from Nortek.



RS232 with option for analog input:

Underwater Connector				Termination	
Pin. No	Wire Color	Purpose		Pins	Description
3	Black	RS232 Tx	Twisted Pair	2	
4	White	RS232 Rx		3	
5	Black	RS232 Gnd	Twisted Pair	5	
6	White/ Purple	Power Output		Red wire	
7	Black	Analog Ch. 2	Twisted Pair	Green wire	
8	White/ Orange	Analog Ch. 1		Yellow Wire	
1	Black	Power Gnd	Twisted Pair	Black Wire	
2	White/Red	Power +		Red Wire	
Screen terminated at pin 1 in underwater connector, unterminated at PC side.					
Ref: N2100-005H					

RS422. Note that Tx and Rx refer to the instrument and not the PC:

Underwater Connector				Termination	
Pin. No	Wire Color	Purpose		Pins	Description
3	Black	RS422 Tx +	Twisted Pair	7	
4	White	RS422 Tx -		2	
7	Black	RS422 Rx -	Twisted Pair	8	
8	White / Orange	RS422 Rx+		3	
5	Black	Sync. Out	Twisted Pair	Black Wire	
6	White / Purple	Sync. In		Green Wire	
1	Black	Power Gnd	Twisted Pair	Black Wire	
2	White	Power +		Red Wire	
Screen terminated at pin 1 in underwater connector, unterminated at PC side.					
Ref: N2100-108					

Wiring of RS232 with option for analogue outputs:

Underwater Connector				Termination	
Pin. No	Wire Color	Purpose		Pins	Description
3	Black	RS232 Tx	Twisted Pair	2	
4	White	RS232 Rx		3	
5	Black	Ground	Twisted Pair	5	
6	White/Purple	Analog Z*		Red Wire	
7	Black	Analog X	Twisted Pair	Green Wire	
8	White/Orange	Analog Y		Yellow Wire	
1	Black	Power Gnd	Twisted Pair	Black Wire	
2	White	Power +		White Wire	
Screen	Bare	Ground	3 bare wires for grounds, connected internally to power ground.		
Ref: N2100-004					

*Optional version outputs pressure instead of Z-Velocity

3.7.1 Using Long Cables

RS232 data communication at 9600 baud will normally work fine for cables up to 50 m long, depending on the environment. If you want to run a longer cable, you can switch to RS422 by installing a different wiring harness you can get from Nortek.

You can also try using RS232 with longer cables by reducing the baud rate. Keep in mind that RS422 is a more reliable means of communication than RS232; changing environmental conditions could cause RS232 communications to fail over a long wire without apparent reason.

You should consider voltage drop across the cable, particularly if you use the two highest power settings. Design your power supply and cable so that the voltage stays below 15 VDC for the Aquadopp/AquaPro or 18 VDC for the AWAC, and never falls below 9 VDC.

3.7.2 Harness (internal wiring)



Figure: Harness and harness pins

Pin	Function
1	Power Ground
2	+ External Power Supply
3	Power Ground
4	+ Battery Supply
5	X Analog Out
6	Y Analog Out
7	Z Analog Out
8	Auxiliary Analog Out
9	CTD Power Out
10	Signal Ground
11	RS232 Tx
12	RS232 Rx
13	CTD RS232 Tx
14	CTD RS232 Rx
15	Analog In 1
16	Analog In 2
17	RS422 Tx+
18	RS422 Tx-
19	RS422 Rx+
20	RS422 Rx-
21	Sync Out
22	Sync In
23	+3.3V LP
24	RS422 3.3V Supply (grounded for RS232, shorted to pin 23 for RS422)

3.8 Advanced Servicing

The following chapters concern working inside an instrument and advanced servicing. This should only be done by a Nortek professional or if a Nortek representative has authorised you.

3.8.1 Changing a Transducer Head

The following procedure outlines how to change a transducer head. You will find the necessary tools in the toolkit that came with the instrument; 7/64" and 1/16" hex driver and silicone grease. Note that the procedure for changing a transducer head also includes updating the instrument's head configuration file.

A. Start with the procedure described in Accessing the Circuit Board . If you are working with a pre-midlife instrument; remove the two bags of desiccant taped around the board and gently disconnect the ground strap on the reverse side of the board.	
B. Unscrew the two screws fixing the main board to the head board, and pull the head away from the board.	
C. Use the same screws to attach the new head/probe to the main board. Remember to put on new O-rings with silicone grease (see section Connector Care for more) on the sensor head. Be careful not to squeeze the cables attached the head board between the main and the head board when connecting them.	
D. Reassemble the instrument.	
E. Load a new headfile into the instrument as described in Replacing Heads/Boards .	
F. Set the pressure offset .	

After changing a transducer head, it is a good idea to run a simple [function test](#) before deploying.

3.8.1.1 Replacing Heads/Boards

- The head configuration file must be updated whenever the instrument head has been replaced. Features dependent on correct head file are tilt, pressure and the transformation matrix.
- Features dependent on the circuit board are magnetometer (compass) and temperature.
- All parameters are hardware revision dependent.

After replacing a head or board, the recorder should be erased and the firmware should be updated.

3.8.1.2 Update Headfile

Most of the sensors in a Nortek instrument have to be calibrated to keep the specified accuracy. This and the fact that we offer flexibility in probe geometry, deployment orientation and external output/inputs make it necessary to store a number of parameters to make the instrument perform as intended. This is stored in the headfile. It is actually misleading to call it a headfile; it has parameters that are dependent on the instruments electronics as well. We make the file when producing the instrument, and it is saved in the respective instrument (we also keep a copy at Nortek).

Calibration parameters stored in the headfile:

- Serial number
- Pressure sensor calibration data
- Tilt sensor calibration data
- Beam to XYZ transformation matrix (conversion between the coordinate systems)

- The transducer frequency
- Number of beams
- Tilt sensor orientation
- Compass alignment data
- Temperature sensor calibration data
- Compass calibration data

The last two are dependent on the instrument electronics, not the probe head.

The head configuration file is sent from us to you upon request. When you have received the .bin file, proceed with the following:

- Connect the instrument to a PC.
- In the instrument software, select Configuration > Sensor head.
- Browse and select the new headfile and click "Open".

When the head file is configured, it is important to:

- Set the pressure offset (Section 1.2.2)
- Level the instrument and confirm the tilt reading (Section 1.1.2.2)





In certain situations Nortek Support may ask you to download your current head file. To do so follow these steps:

- Connect the instrument to the PC and start instrument software.
- In the Terminal Emulator click Log File and give the file a descriptive name.
- Type GH, which is short for "Get Headfile", and Send.
- Stop logging the file.
- You have now captured the data necessary for a head file.
- Remove the last two binary characters (06 06 which is acknowledge).
- Save the file as a *.bin

3.8.2 Accessing the Circuit Board

Aquadopp and AquaPro:

The following procedure describes how to access the circuit board, necessary tools can be found in the supplied toolkit.

<p>A. Remove the four #6-32 x 3/4" titanium screws and washers holding the end cap to the pressure case.</p>	
<p>B. Disconnect the 2-pin (battery) and 9-pin (harness) connectors.</p>	
<p>C. Pull the battery out of the pressure case.</p>	
<p>D. Remove the #6-32 x 3/4" titanium screws and washers holding the transducer head to the pressure case.</p>	

E. Carefully, slide out the head with the circuit board attached. Do not put a lot of pressure on the sensor head itself, as the connection between the sensor head and head board represent the weakest point. Pull/push the main board instead.



When reassembling the system, the following is important:

- Make sure that there is no dust or particles on the O-rings on the head or the endbell, and that they are whole. Apply silicone grease to the O-rings to ensure a complete seal.
- A fresh desiccant bag should be included in the pressure case, as humid air can condense enough water do damage the electrical circuitry.
- Be careful when sliding the circuit board into the pressure housing; it is easy to make scratches, and these scratches may cause instrument leakage.
- Attach the head to the housing with the titanium bolts. Make sure the bolts have both a spring washer and a flat washer.
- Insert and connect the battery, and attach the endbell. Make sure that also these bolts have both a spring washer and a flat washer.
- Read also about the [recommended torque for securing screws](#).

AWAC:

- 1) Remove the three titanium screws and washers holding the transducer head to the housing. Take note (or picture) of how the AWAC heading and canister is aligned.
- 2) Carefully lift the transducer head and remove the harness connector. Be careful not to scratch the housing surface. Set carefully down the transducer head with the transducers facing down.

When reassembling the system, the following is important:

- Make sure that there is no dust or particles on the O-rings on the head, and that they are whole. Apply silicone grease to the O-rings to ensure a complete seal.
- A fresh desiccant bag should be included in the pressure case, as humid air can condense enough water do damage the electrical circuitry.
- Attach the harness and carefully place the transducer head on the housing. Make sure to align the transducer head with the mainboard correctly; the compass board must be aligned with the engraved X on the head.
- Make sure that the screws have both a spring washer and a flat washer. Tighten each screw little by little in turn, to ensure that there is equal pressure on the O-Ring.
- Read also about the [recommended torque for securing screws](#).





3.8.3 Installing a Memory Board

3.8.3.1 Midlife - Aquadopp, AquaPro and AWAC

Installing a memory board or a Prolog on the AWAC follows the same procedure as below; the difference is the shape of the main board (circular instead of rectangular). When ordering a memory upgrade from Nortek you will receive the following:

<ol style="list-style-type: none"> 1. Recorder / ProLog 2. Screws / Bolts 3. Standoffs 4. Nuts 5. Lock Washers 	
---	--





To install it, follow the procedure as described below:

<p>A. Access the circuit board.</p>	
<p>B. Loosen the four (relatively short) screws and remove the compass board from the main board.</p>	
<p>C. Insert the four long screws through the holes in the corners of the compass board, and then through four standoffs. Carefully insert the screws through the holes on the main board, and then through four more standoffs. Make sure the connector between the compass board and the main board clicks to indicate connection.</p>	
<p>D. Carefully position the Recorder board (image to the right) and fit it gently to the matching connector on the main board (image to the left).</p>	
<p>E. Secure the assembly with lock washers and nuts.</p>	
<p>F. For the AWAC, make sure to align the compass with the X-marking on the head. If not, the X- and Y-axis will be wrong.</p>	
<p>G. After reassembling the instrument, erase the recorder, and check that the system reads the correct recorder size.</p>	
<p>H. Adding/replacing ProLog: always remember to upgrade/reinstall firmware after installation</p>	

3.8.3.2 Pre-midlife - Aquadopp and AquaPro

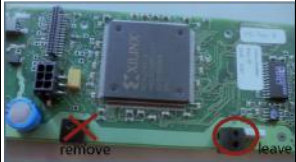
When ordering a memory upgrade from Nortek you will receive the following:

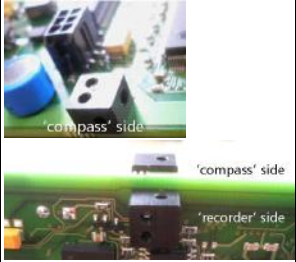

<ol style="list-style-type: none"> 1. Long nylon screws 2. Mounting blocks 3. Short nylon screws 4. Nylon nuts 5. Threaded metal bolt 6. Nylon standoffs 7. Recorder board 	
---	--

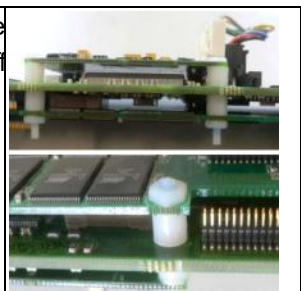
<p>A. Start with accessing the circuit board (Section 1.3.2).</p>	
<p>B. To remove the compass board, start removing all screws and blocks with the exception of the right mounting block on the main board, as shown in the image. The point is to add two new mounting blocks (2) as support for the recorder board.</p>	
<p>C. Screw the metal bolt (5) through the mounting block (2) in the correct hole (indicated in the image).</p>	
<p>D. Screw the two blocks from (C) through the holes in the main board and through another mounting block on the opposite side of the board (both new blocks is to be placed on the same side of the main board). NOTE that the block on the 'compass' side of the card sticks out over the edge of the board, whereas the block on the 'recorder' side do not.</p> <p>Please note the positions of the various holes in the mounting blocks: Make sure that the twin holes are positioned away from the center of the main board. It is essential that they are positioned correctly.</p>	
<p>E. Insert the two long nylon screws (1) through two of the holes in the compass board, then through the nylon standoffs (6). Continue with carefully inserting the screws through the two holes (at the opposite side of the mounting blocks) on the main board. Attach two more standoffs, and carefully position the recorder. Make sure the connector between the main board and the recorder board clicks. Apply a little LocTite to all plastic screws.</p>	

<p>F. Fix the recorder and the compass boards to the mounting blocks with the short nylon screws (3). Apply a little LocTite to all plastic screws. Cut off excessive length on the long nylon screws.</p>	
<p>G. Connect the compass and the main board with a connector (see image in point E, to the upper right)</p>	
<p>H. After reassembling the instrument, erase the recorder and check that the system reads the correct recorder size (Section 1.5.3).</p>	

3.8.3.3 Older Paradopps

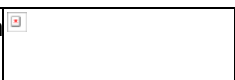
Some of the older systems will not fit the connector between the main board and the recorder, and thus need an additional cable. The recorder board looks a little different, but it is essentially the same process as described above. Two steps are added:



<p>C(2). Attach the cable to the main board before fixing the recorder to the main board.</p>	
<p>C(3) Attach and bend the cable as shown, to avoid cable getting caught while inserting the instrument into the housing.</p>	

3.8.3.4 Continental and Pre-midlife AWAC

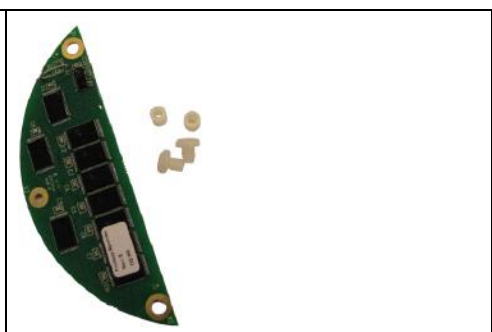
When ordering a memory upgrade from Nortek you will receive the following:

<ol style="list-style-type: none"> 1. Memory board 2. Nylon screws (x 2) 3. Nylon screws / standoffs (x 2) 	
--	--

<p>A. Unscrew and remove the bolts that hold the head to the system.</p>	
<p>B. Gently lift the head up and out, and place the transducer side down on the table. Note how the circuit board is attached; it must be inserted the exact same way when reassembling. Take care not to damage or stretch the cables or the O-rings.</p>	
<p>C. Unclip the cables: the ground cable at the joint and the main cable at the circuit board.</p>	

D. Unscrew the two nylon screws (area marked in the image), and replace them with two nylon screws / standoffs (3).	
E. Carefully align the connector on the recorder with the matching connector on the circuit board and gently press down.	
F. Apply a little LocTite to the two screws and fasten the recorder to the standoffs.	
G. When reassembling the instrument, make sure to fix the head correctly. Align the recorder board with the X-marking on the head (red circle in the image). This must be stressed since the X- and Y-axis will be wrong if assembled incorrectly.	
H. Reattach the cables between the head and the main board.	
I. Fasten and tighten bolts well (Section 1.6.3)	
J. Erase recorder, and check that the system reads the correct recorder size (Section 1.5.3).	

3.8.4 Installing a DC/DC

In the instrument, a DC/DC converter is used to downconvert the supply voltage to 15 V. The DC/DC converter comes in two versions, one for the AWAC and one for the Aquadopp/Aquadopp profiler.



Aquadopp and AquaPro

Open the instrument just as you would when replacing a battery pack ([Changing a Battery Pack](#)). The DC/DC takes the place of one 50Wh battery pack.

A. Remove the endbell and remove the batteries (if relevant)	
B. Connect the DC/DC harnesses to the instrument harness. There is only one of the two Molex connectors pictured that will fit.	
C. Slide the DC/DC carefully into the canister	
D. Connect the second Molex connector to the endbell	
E. Reattach the endbell to the pressure case and mount with four titanium bolts and washers. Make sure that there are no dust or particles on the O-rings on the endbell, and that they are whole. See Recommended torque when securing screws - you do not need to fasten them too much	
F. Check that it is working. Take note of the voltage limitations/requirements of your updated system.	



AWAC

Before opening the AWAC, note how the transducer head is aligned with the housing. Taking a picture may be a good idea. Follow the procedure described in the [Accessing the Circuit Board](#).

A. Open the AWAC, disconnect cables and remove electronics so that the starting point is the AWAC canister only.	
B. Connect the two DC/DC harnesses. There is only one way to do this	
C. Slide the DC/DC carefully into the canister; be careful not to scratch any surfaces. Secure it by fixing the four screws into the canister, as seen in the image below.	
D. Connect the 24-pin Molex connector to the main PCB.	
E. Check that it is working. Take note of the voltage limitations/requirements of your updated system.	

3.8.5 Changing the Wiring Harness Aquadopp and AquaPro

You will find the necessary tools in the toolkit that came with the instrument; 7/64" and 1/16" hex driver and silicone grease. Use Loctite as described below, if accessible.

A. Access the circuit board.	
B. Unscrew the two screws that hold the harness in place	
C. Press the little tap on the connector, and pull the harness off.	
D. Attach the connector of the new harness.	
E. Align the mounting blocks at the round disk with the holes on the main board. Add a little Loctite and fasten.	
F. Add a thin layer of silicone grease on the harness's O-ring.	
G. Carefully insert the system back into the housing.	

AWAC

For the AWAC, the procedure is simpler; [access the circuit board](#), replace the harness, and carefully align the transducer head correctly on the housing again and secure.

3.8.6 Changing the Output Power for Auxiliary Sensors

3.8.6.1 Midlife Electronics

Midlife electronics change the power levels with a simple command in the terminal emulator:

Voltage level	Command	Max current
RAW	OPWRBA	500 mA
+5V	OPWR5V	250 mA
+12V	OPWR12	100 mA

3.8.6.2 Pre-midlife Electronics

You can change the output voltage level that is supplied to external sensors. This is typically needed if an external analog sensor (e.g. OBS) operates in a specific voltage range and the raw battery power does not fall within this range. The default output voltage level is RAW (battery or external adapter). This can be changed to +5V or to +12V by changing the position of a 0-W resistor. The three resistor positions share one pad so the modification should be straightforward.

Voltage level	Resistor position	Max current
RAW	R270 (default)	500 mA
+5V	R268	200 mA
+12V	R269	50 mA

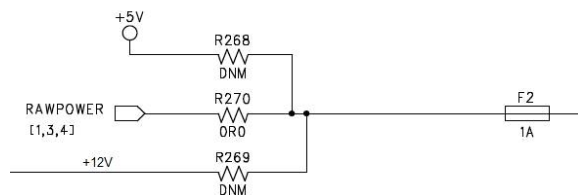

Mounting Guideline

SECTION

4

4 Mounting Guideline

This section covers:

- ✓ What considerations should be made before deploying
- ✓ A brief review of the forces working on a typical mooring
- ✓ Mounting alternatives and equipment
- ✓ Deployment planning and special considerations
- ✓ List on how to ensure quality data

The primary goal of any instrument deployment is to keep the mooring at the chosen location and to make as accurate measurements as possible. The success of a deployment depends both on the ability to estimate the range of conditions that the deployment site may be exposed to and to design a structure that will survive those conditions. The most important environmental conditions are wind, waves, currents and tides. In addition, the pressure constraints, fouling and corrosion are aspects that will influence the deployment to a certain degree.

It is wise to think through all aspects affecting the deployment and to have a clear target for the deployment. What do you want to measure, and for how long? At which location, and what influences will the surrounding environment have on the measurements? The different seasons of the year may also present different limitations and challenges.

The deployment site should be carefully assessed. There are a number of aspects to consider regarding the deployment site that might play a role when it comes to successful data collection. To mention a few:

- An idea about the bathymetry of the area and the bottom conditions may avoid failure during deployment. Burial of the instrument in sandy areas is of course something that should be avoided.
- The salinity (and temperature, but this is measured directly) affects the speed of sound, and knowing the salinity level ahead of the data collection may save time when post-processing the data.
- The scattering level is usually not a problem, but should be considered in areas with few particles in the water (e.g. the area between 1000 m below the surface and 100 m above the bottom is challenging from a Signal-to-Noise Ratio (SNR) point of view).
- If the instrument is located in an area with seasonal sea ice, a surface signature (buoy) is usually not recommended.
- If there are any other human activities at the site, e.g. trawling, this can be disruptive and even destructive for the measurements.
- The choice of mooring line, flotation and anchor should depend on the type of mooring and environment in which it is deployed.

4.1 Forces Acting on a Deployment

When working with mooring design it is important to find the appropriate compromise between the various forces acting on the deployment system.

Forces in the vertical direction include:

- Buoyancy (mass x gravitation), which is positive upwards (buoy) and negative downwards (anchor).
- Tension from above.
- Tension from below.
- Drag from any vertical current.

Forces in the horizontal direction:

- Angled tension from above.
- Angled tension from below.
- Drag from any horizontal velocity.

4.1.1 Buoyancy

Positive buoyancy comes from objects that have an upward directed force when submerged, that is, objects that have a density that is lower than the water around it. Negative buoyancy represents a downward force. To determine the buoyancy of an object, knowledge about the mass and the volume of the object is essential. Remember that the actual buoyancy is the mass of the seawater the object displaces (volume of object * density of water) minus the mass of the object (Archimedes' Law). It is of primary interest to keep a mooring as vertical as possible; therefore, sufficient buoyancy is essential, at the same time as the handling of the deployment is not affected (e.g. not too heavy).

4.1.2 Tension

The tension in the mooring line is the sum of the static and the dynamic load. The tension pulls downward, upward (depending on buoyancy), or in an angle, but it never pushes. The static component is linked to the weight of the mooring line, the instrument, and the other immersed constituents of the deployment. The dynamic load is induced when the deployment moves up and down in step with the vertical and/or horizontal motion introduced by waves and currents. The dynamic load is also influenced by drag forces (explained in the next section) caused by the mooring line and payload's instantaneous speed, and the inertia force, caused by the mooring line and payload's instantaneous change of speed.

4.1.3 Drag

The drag force (hydrodynamic resistance) is a resistive force that opposes the motion of an object through a fluid. The drag experienced by an object depends on the size and form of the object, and the velocity of the surrounding currents or the wind. The drag force is a combination of viscous and pressure effects. These two effects are concurrent, and their relative magnitude depends on the flow past the object. If the flow is laminar, shear stresses dominate, and the drag is mainly due to friction of the fluid on the surface of the object. The combination of fluid speed and shape of the object may result in a wake behind the object. The pressure difference between the upstream and downstream side of the object causes pressure drag.

Most drag data are empirical and obtained by direct measurements, but for an approximate calculation of the drag, the following equation can be used:

$$(1) \quad F = \frac{1}{2} C_D \rho A V^2$$

Here, F (N) is the drag force, ρ (kg m^{-3}) is the mass density of the fluid, A (m^2) is the cross-sectional area and V (m/s) is the relative velocity. The drag coefficient, C_D , is a non-dimensional force that is dependent upon the body shape in the flow field, and can be calculated by:

$$(2) \quad C_D = \frac{2F}{\rho A V^2} = f(Re, \alpha)$$

Where α is the angle between the flow direction and the specified body axis (no tilt: $\alpha = 0$). Re is the dimensionless Reynolds number, defined as:

$$(3) \quad Re = V \frac{d}{\nu}$$

Where d (m) is the characteristic length scale of the object and ν (m^2/s) is the kinematic viscosity. The Reynolds number is used to characterize flow regimes; it tells us what type of flow we can expect in the wake of an object. It describes the ratio of the inertia forces over the viscous forces. In case of low Reynolds number ($Re < 1$) the viscosity effect is large and we can expect laminar flow behind the object. If the Reynolds number is large ($Re > 1000$), the flow is turbulent. Note that these quantities/limits should only be considered indicative. The take home is that the flows become turbulent at high values, where “high” means values much greater than unity. When the flow is turbulent, [vortex shedding](#) may occur.

There are two primary problems associated with the drag force; mooring excursions, and inclination of the mooring components. Horizontal displacements cause errors in current observations. This is due to the reduced velocity relative to the current sensor during the period the mooring needs to reach its equilibrium after a change in currents. The instrument may also move deeper (lay down) in the water column as a result of exposure to drag forces, with measurements in a different location than intended as a result. In addition, the velocity data may be contaminated/useless due to excessive tilt. In addition to the steady drag force, there are also fluctuating lift and drag forces associated with the already mentioned shedding of vortices.

In order to predict changes in the excursion and inclination when designing a deployment, drag forces must be calculated for the expected current conditions. These can also be used to predict errors in the data, since a certain amount of movement cannot be avoided.

4.2 Mounting Alternatives

Most Nortek products can be used in either stand-alone or online mode. In stand-alone mode, data are collected to the internal recorder and power comes from internal or external batteries. In online mode, data are transmitted to shore in such a way that the measurements are continuously available.

4.2.1 Stand-Alone

4.2.1.1 In-line Mooring

Two general in-line mooring methods are presented, referred to as an L-mooring and an I-mooring.

The L-mooring, illustrated in the figure below, is a deployment setup that is suitable for shallow water moorings. The advantage of the L-shape is that the instrument is protected from the winds, waves and currents that the surface buoy is exposed to. This will prevent waves and bad weather from influencing the data quality (depending on the distance from the surface of course). Having the hardware submerged and away from the most dynamical part of the water column leads to a considerable reduction in component fatigue due to surface-wave action. The surface buoy works as a signature of where the instrument is located, and as an aid in the retrieval of the system.

It is recommended to attach a subsurface buoy along the mooring line resting at the bottom. If something should happen with the surface buoy or the mooring line attached to the surface signature, this form of backup recovery is a good idea. It is easier to catch the line if it is lifted off the bottom by the buoy compared to when it is resting along the bottom. Another improvement recommended is to add a subsurface buoy above the anchor to the left, as illustrated. This will prevent abrasion of the line during e.g. low tide. The magnitude of the buoyancy must be such that no part of the cable touches the ocean floor under slack conditions.

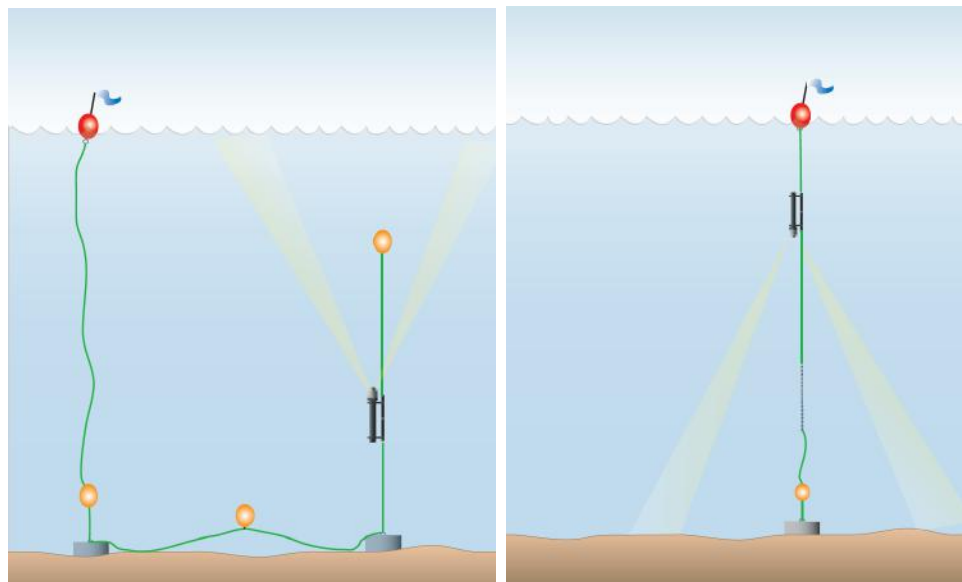

Figure: L-mooring

Figure: I-mooring

The bottom mounted surface penetrating I-mooring can be used at all depths. The figure above (right) shows a typical I-mooring with the instrument pointing downward. An alternative is to mount the instrument looking up.

The disadvantage of using a surface signature like this is that the buoy is exposed to storms, waves, winds and strong surface currents. The motion transferred to the buoy by the environment makes this method tortuous, as this motion contaminates the instrument measurements. One must thus consider the effect of surface waves, ocean currents, bio-fouling and other factors that can vary with the time of year, location and regional climate and weather patterns. Storms, ships, ice, and vandalism can damage

surface buoys. A good alternative is to use a subsurface float; an [acoustic release mechanism](#) is a keyword for this solution.

A taut mooring extending from the surface to the bottom must include a mooring line that has the ability to stretch, to compensate for the large vertical excursions that the buoy may experience during the change of tides and with passing waves and swells. A taut mooring has the advantage of reducing the buoy watch circle (the freedom of movement of a buoy, defined by the mooring length) and sensor motion, and it is relatively easy to deploy. The disadvantage is that the wave action and high static tension under severe current conditions cause high dynamic loading. The latter can be reduced by replacing a part of the mooring line with a slack part, as the figure above illustrates, referred to as a semi-taut mooring. The disadvantage then is that the motion of the buoy and the sensor may become considerable, thus introducing errors in the measured velocity. In the above illustration, a chain (working as a [dead weight anchor](#)) is added right above the slack part to reduce excessive motion. In addition, it is a good idea to include a subsurface buoy along the slack line, to prevent the slack part to be exposed to rubbing against the anchor and bottom during e.g. low tide.

A taut mooring is recommended where there is minimal variance of water level, low currents and small waves. The dynamic loading requires use of a larger size anchor than semi-taut mooring. The semi-taut mooring enables more buoy movement than the taut mooring, but it absorbs better the energy that might disrupt the performance of the taut mooring.

It is possible to attach several instruments along the same mooring line. The vertical distance between each instrument attached (and the along beam range of each instrument) must determine if the instruments should transmit signals out of step with each other, to avoid interference. To ensure vertical orientation for each instrument along the line, you should include a subsurface float above each instrument. The minimum distance between the instrument and the buoy should be 10 m, to avoid interference from the buoy in the collected data.

The design of the mooring must focus on minimizing the motion of the instrument and disturbance in the flow, so that the sensor does not sample in its own turbulent wake, as this may generate significant errors in the data.

4.2.1.2 Subsurface Buoy

The most common reasons for mounting an instrument in a subsurface buoy are 1) measurements required in deeper water and 2) better resolution of high frequency waves. These two reasons are intimately coupled. Long term directional wave measurements in deep water environments are intrinsically difficult to achieve. This depth limitation has to do with the spatial separation of the measurement cells, described briefly in [Measuring Waves](#) section, and more thoroughly in the Principles of Operation document, part II. The ability to mount a wave gauge on a subsurface buoy permits the instrument to be close enough to the surface for high quality wave measurements yet be removed from the dangers of exposure at the surface.

The type of subsurface buoy illustrated in the figure above is designed to allow the instrument to make velocity profiles unobstructed by the mooring hardware. The advantage is, as mentioned, that the buoy is located away from surface forcing, thus it is not subject to surface excitation. The disadvantage is that if the currents in the area are too strong, lay down of the mooring and unrecoverable high tilt may invalidate the measurements. In addition, current profilers cannot measure the top 5-10% of the water column due to acoustic [Sidelobe interference](#).

A deployment can be improved by adding a subsurface buoy right above the anchor to the left (figure above), to avoid rubbing, and a buoy along the line resting at the bottom, to make it possible to catch and retrieve the instrument in case of surface buoy loss or mooring line snap.

The subsurface buoy may rotate under the influence of tides, waves and currents. This restricts the use of subsurface buoys to deployments with the goal of measuring current profiles or current areas, and to instruments capable of processing wave data using the SUV method (Surface tracking and U & V velocities, cf. Principles of Operation, Part II), if wave data is of interest. The movements of the buoy are measurable by sampling compass, pitch and roll data simultaneously with velocity measurements, with the same rate, enabling elimination of the buoy movement from the data. Most wave processing methods are mathematically incapable of solving wave parameters if there is instrument movement and thus require that the instrument does not move or rotate during data collection. This problem is solved by utilizing the SUV processing method. This method requires AST and is therefore exclusive to the AWAC system.

As an alternative to the surface buoy signature, the instrumentation may be recovered by disconnecting the mooring line from the anchor by use of a pop-up buoy with an [acoustic release](#) mechanism. With a [pop-up buoy](#), the surface signature is no longer needed.

Using a subsurface buoy with a short mooring line to the bottom (corresponding to a bottom mount) is convenient in coastal areas with moving sand, waves or very soft bottom types, as this avoids burial. In regions with irregular / sloping bottoms, use of subsurface buoy facilitates vertical orientation of the instrument, as opposed to using bottom frames. Subsurface buoy moorings are also favorable at

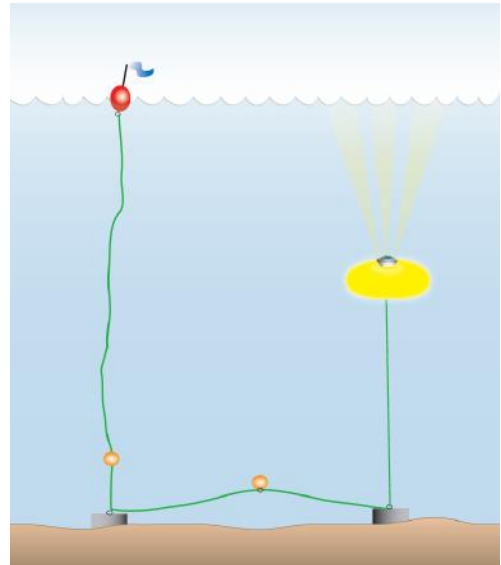

Figure: Subsurface buoy with instrument mounted inside

latitudes with seasonal ice, because the buoy allows continuous collection of data undisturbed of the sea ice.

When using a subsurface buoy it is important to understand how the [natural frequency](#) of the buoy may contaminate the data collection.

4.2.1.3 Bottom Mount

The bottom frame is typically used in fixed deployment situations. The advantage of mounting the instrument at the bottom is the reduced chance of measurement errors due to instrument motion and movement from interaction with the surface (waves, wind), or motion transferred from the mooring line during in-line mounting. When using a bottom mount, the emitted beams are not in the risk of encountering any obstructions related to the deployment setup. It also avoids shipping hazards to some extent.

If the deployment depth is shallow, the mounting frame may be exposed to strong forces due to the orbital currents that waves generate. The design of the frame should therefore be compact and heavy. This and other considerations regarding bottom frames are listed in the next chapter. Note that if your plan is to make measurements near the surface from a bottom mounted instrument, the tilt must be as small as possible. If the bottom is not level, it might a good idea to use a [gimbal](#) together with the AWAC, or use a subsurface buoy as mentioned in the previous section.

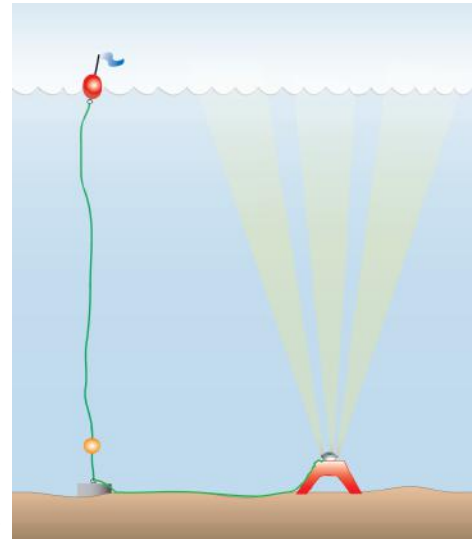

Figure: Bottom mounted instrument

If measuring waves is the focus of a deployment, bottom mounted gauges work well in shallow water. However, in depths greater than a certain limit, bottom mounted wave gauges are not able to provide the directional resolution necessary for most research and commercial requirements. This limit is determined by the signals associated with orbital velocities and pressure attenuation, and the fact that they attenuate exponentially with depth. Read more about this in the Principles of Operation, Part II.

4.2.2 Online

4.2.2.1 Offshore Cable

The Nortek Online cable is specifically designed to withstand the harsh ocean environment, suited for applications requiring robust communication or large bandwidth. The cable is tough, resilient and easy to handle. Nortek recommend using this cable for all long term monitoring projects. This is an excellent solution for online applications where the risk of losing a surface buoy is too great.

The instrument is connected to a 2 m extension cable (see below) that is molded onto the tough online cable. To make sure the instrument connector does not easily come loose, a braided jacket ("Chinese finger trap", see element 0 in the Figure below) is attached to the online cable and should be attached to the deployment frame before or during deployment. The cable is suitable for providing power and communication to Nortek instruments (typically the AWAC) for distances of up to 3 kilometers. The outer jacket of the cable is a tough and pliable polyurethane jacket that is especially formulated for exposure to abrasion. The cable has a breaking strength of more than 350 kg but should not be used for hosting purposes.

Cables arguably provide the most reliable means of communication. A less obvious drawback is that due to their exposure there is an element of survivability which is very dependent on the environment around the cables. It is important to be aware of these risks as well as the precautions that can be taken to minimize them:

Weighting cables. This is important in order to reduce the exposure of a cable. The cable has a weight of 27 g per meter in seawater and a specific gravity of 1.23. Thus, the cable has negative buoyancy (it will sink). Nevertheless, it should be firmly weighted to the seafloor as this makes the cable less susceptible to wear and tear. Exposed cables are more susceptible to being snagged by fishing gear and anchoring.

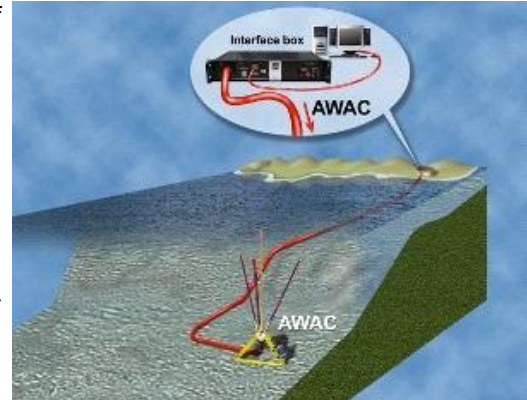

Figure: Bottom mount and online cable

Strain relief. The concept here is that when the cable is exposed to heavy loading, the connectors will stay connected, but separate before the cable breaks. The strain relief mechanism is designed to take a load of 200 kg. The already mentioned “Chinese finger trap” attached to the frame relieves the connector between the instrument and the cable.

Voltage drop. The voltage drop (V_{drop}) along a cable is a function of the current drain (I), linear resistance of the cable (RI), and the cable length (L); $V_{drop} = I \cdot RI \cdot L$. The typical current drain during the measurement cycle for an AWAC is 1 amp. The Nortek cable has a linear resistance of 10.6 Ohms/km. A cable of 1 km will thus have an expected voltage drop of 10.6 volts. Since Nortek equipment typically operates between 9-15 VDC (or 9-18 VDC for the AWAC), it is often easier to use a DC-DC converter at the instrument. For cables longer than 50 m, a DC-DC converter is required. Nortek offers the AWAC with a 48 volt DC-DC converter.

Segmented cables. For distances greater than 1000 meters, using a cable composed of segments is often recommended. In the event of a cable break the cable will have to be replaced and this can become expensive if the cable is in one piece. One solution is to construct the cable as a series of cables. If one of the segments breaks, then just that segment needs to be replaced. Since connectors represent a large part of the cost there is however a trade-off as to the length of the segments. The segments are linked with an underwater linkable connector that can be detached or attached by a diver. Nortek's experience is that segments of 500 meters are reasonable for the bottom and segments of 200 meters for the portion that extends through the energetic portion of the water column (sea-air interface, surf zone, etc.).

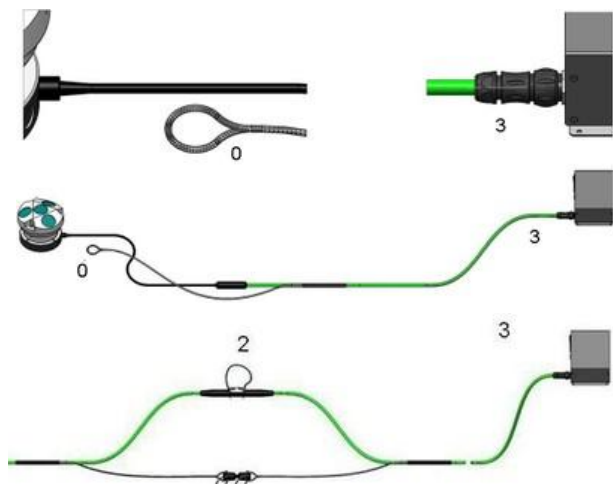

Figure: Nortek Online Cable. Element 0: "Chinese finger trap", 2: Strain relief, 3: Connector to interface box

Almost all installations have the cable lying on the seabed; however there are some installations with cables pulled up to buoys. The latter configuration is however generally discouraged unless one is certain that surface conditions never become severe (e.g. small enclosed bodies of water). Surface buoys tend to rotate, either due to waves, changing wind conditions or tides, and sooner or later the cable will break due to twist caused by this rotation.

It is possible to add backup batteries and memory to online systems. The battery will ensure that the instrument continues to collect data even if the cable is disconnected and the extra memory ensures that the data are stored.

4.2.2.2 Inductive Modem

The Aquadopp Inductive Modem option enables communication over a jacketed (isolated) mooring line. The purpose of an inductive modem system is to retrieve data from the instrument without the need for a sophisticated underwater cable. Instead, a low-frequency signal is generated in the mooring cable. The communication to the topside device is handled with the Seabird inductive modem whereas support for the Inductive Modem Module (IMM) communication protocol and transfer of data from the Aquadopp or DW Aquadopp (6000m) to the IMM is provided by a special version of the Aquadopp firmware.

The Aquadopp can be configured and deployed through the Aquadopp/DW Aquadopp software, and it can be set to store data in either ASCII or binary format on the IMM. The Aquadopp can communicate inductively through the IMM which is located next to the Aquadopp electronics inside the pressure housing (see illustration below). (The board is seamlessly integrated with Aquadopp electronics and can be an upgrade to any Aquadopp shipped after the summer of 2008 (firmware version 3.xx and above)). The IMM is connected to an inductive coupler, which in turn is clamped onto a jacketed mooring line to form a loop, using seawater as the return path.

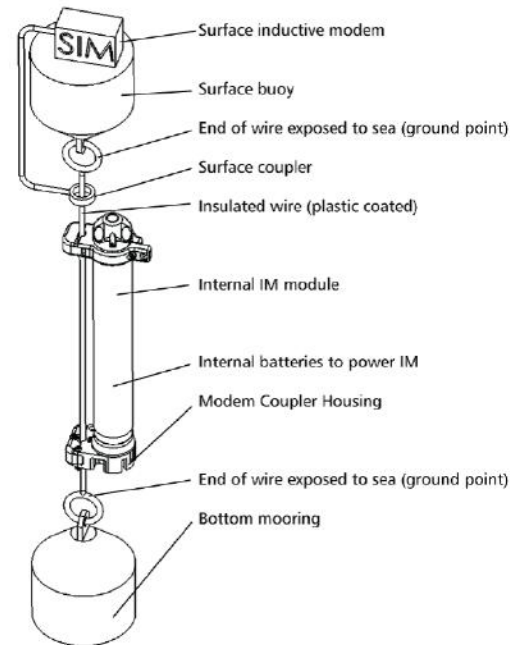

Figure: The main components of an inductive modem system

Before you can use the inductive modem option, the IMM must be enabled in the software. This must be done before the deployment as part of the deployment planning process. As with standard deployment, the instrument must be in deployment mode in order to work with the inductive modem. Online measurements with the Aquadopp can be conducted only when the IMM option is disabled.

Data collected during the deployment will be stored in the Aquadopp recorder and also sent to the IMM electronics module. The data are then transferred from the IMM module to the Surface Inductive Modem (SIM) as part of the inductive communication between the IMM and the SIM.

Note: If diagnostic data collection is enabled in the deployment planning menu, the diagnostic data will not be transferred to the IMM and the data will only be collected after the regular data has been transferred to the IMM. Consequently, the collection of diagnostic data can be delayed if the Aquadopp is waiting for access to the IMM. This will be the case if the IMM is busy communicating with the SIM.

Read more about inductive modem integration in the System Integrator Manual.

4.2.2.3 Acoustic Modem

The acoustic modem option makes it possible to transfer data from the instrument to the surface without the use of cables.

The Nortek Acoustic Modem is constructed of a Benthos OEM Modem, an omni-directional transducer and a DC-DC converter that allows the system to be operated from the same battery power as the Nortek instrument. Only AWAC current and wave measurement system fitted with a ProLog wave processor is supported. AWACs shipped prior to January 1, 2009 require a hardware upgrade in order to support the Prolog and the acoustic modem. The intended use of the acoustic modem is to transfer blocks of data associated with an individual measurement event, which include current profiles and estimates from wave burst measurements. This means that data is streamed from the Nortek instrument. Two-way communication or data download at a user specified time is not supported.

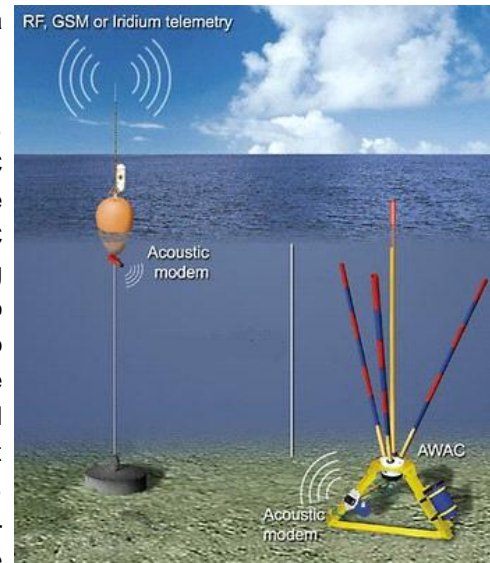

Figure: Bottom mounted AWAC with data transfer over acoustic modem

The modem has been configured with settings that are optimized the fidelity of communications and battery life. This means that the end user does not need to configure the modem itself. The end user is only required to properly configure the Nortek instrument so that it (a) has the correct baud rate setting and (b) streams data out the serial line. More about the configuration can be found in the System Integrator Manual.

It is worth taking a look at some of the more practical aspects of acoustic communication and the associated limitations. Reliability of the modems can vary due to acoustic conditions in the water. The most common issues that can reduce the fidelity of the communications are:

- Competing acoustic instrumentation that operates in the same frequency band as the modems will likely present a problem for communication. It is advisable to identify and remove all sources that could harm communications. Typical sources of noise are echo sounders from ships. Acoustic communication is surprisingly resilient to out-of-band noise from sources such as shipping traffic.
- Multipath, known as reception of the same signal or message due to reflections from boundaries.
- Clear Line of Sight. If you do not have a clear line of sight between the modems, it is very unlikely that there will be communication between them. It is also unlikely that an acoustically rigid boundary can be used to reflect energy in order to achieve an indirect transmission path.
- Shadow Zones. A shadow zone is defined as a region with no direct path of acoustic energy, and only reflected energy may enter this zone. An acoustic shadow zone will occur if the speed of sound profile is not uniform; this will lead to bending of the transmission path or “rays”. A conceptual example is presented in the figure below. The trouble with shadow zones is that they can often exist with a mildly non-uniform speed of sound profile, and that they are usually non-stationary over time. This means that a location may have variable reception.
- Range and Depth. Communication over short distances (approximately 200 meters) is quite reliable. This is particularly true for vertical communication in deep waters with few boundaries. The best operation is when the modems are oriented vertically; the surface modem oriented downwards and the bottom modem oriented upwards. As a rule, vertical communications and short ranges are reliable (i.e.

bottom mount to a buoy / boat), whereas horizontal communication (particularly in shallow water) become increasingly challenging with greater modem separation (e.g., 10 meter depth and 500 meter range).

- Air Bubbles. From an underwater acoustics standpoint, air-water interfaces are more or less impassable. Clouds of air bubbles can largely inhibit acoustic transmission. This is usually a greater problem at the surface where breaking waves create clouds of air bubbles. For buoy mounted acoustic modems we advise mounting the modem away a few meters below the surface where the buoy itself contributes to bubble formation.

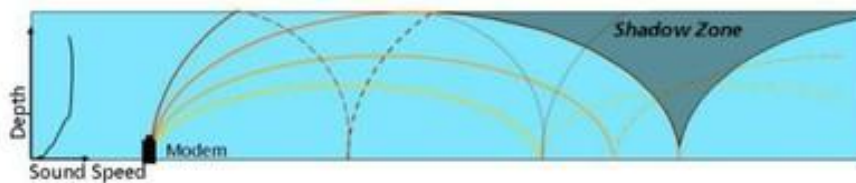

Figure: Illustration of the shadow zone. Note the non-uniform speed of sound profile to the left

4.3 Equipment

4.3.1 Standard Equipment

4.3.1.1 Surface Buoy

The surface buoy may work as a surface signature, retrieval float, as a mounting structure for instruments, as a provider for buoyancy on top of a mooring line or as a surface expression for telemetry. It is important to have sufficient buoyancy on top of the mooring to keep the mooring components as vertical as possible as the mooring must satisfy the depth excursion and instrument inclination criteria. Thus the surface buoy should make sure the instruments maintain constant depth, even during high and low tides etc.

The shape and dimension of the buoy must be considered with the purpose and the design of the deployment in mind. The buoy should in most cases contribute to as little dynamic stress to the mooring line as possible. The buoy will naturally follow the motion of the waves both heave and roll motion. The degree of this motion transferred to the instrument should be restricted, to the greatest extent possible. Spherical buoys are commonly used due to their great strength of weight, ease of construction and their common availability. It is recommended to use hard plastic buoys filled with either foam or air, and not air filled soft plastic buoys. There are cases where the soft plastic buoy has punctured.

4.3.1.2 Subsurface Buoy

A subsurface buoy is used to minimize wave-induced motion of the mooring line and to keep the mooring as vertical as possible. A subsurface float can also help support the weight of the instrumentation and the mooring line itself. In addition, with such an arrangement, if the cable or mooring line should snap, the instrument will have enough buoyancy to rise to the surface (backup recovery). By adding positive buoyancy above the anchor, the risk of entanglement and wear and tear from the bottom is minimized. It is also recommended to attach a buoy along the mooring line resting at the bottom when using an [L-mooring](#). If the surface buoy should be lost or the mooring line should snap, a backup recovery in form of catching the mooring line at the bottom is an option, which is greatly simplified if the mooring line does not rest at the bottom.

When using a subsurface buoy in the upper part of the water column, the buoy should have as low density as possible. The efficiency of the buoy decreases rapidly with its weight. The floating material density must increase with depth to resist the increasing hydrodynamic pressure. Note that the pressure resistance is of concern only for deeper waters. Synthetic foam resists the highest pressure of the ocean; in addition, it is attractive for use in high current regimes. It is wise to use one buoy with large diameter, as this will reduce the drag compared to using a number of small buoys. The buoyancy of the subsurface buoy has considerable influence on the response of the mooring systems.

It is also possible to mount the instrument in a [subsurface buoy](#). For this type of deployment, there are several aspects to consider. The shape of the buoy is not irrelevant; an ellipsoid shaped buoy has for example lower drag than a spherical buoy. The ellipsoid is a good alternative in calm areas, or when the instrument is to be mounted close to the bottom. In areas exposed to relative strong currents, the ellipsoid buoy is not recommended. This is because strong currents will tilt the buoy more and more, until the bottom of the buoy is faced upstream. Then the drag contribution becomes severe. An alternative is to use a streamlined subsurface buoy (shape of a torpedo) called SUBS, that states to be very stable and reduce mooring excursions and inclinations. The SUBS will keep the instrument orientation vertical, even in high current regimes.

The ellipsoid buoy has a tendency to rotate more than the SUBS, but data from an [experiment comparing the two buoys](#) shows that the rotation is slow enough so that the compass is able to keep up with the rotation and provide accurate measurements. Conversely, the SUBS is more stable for the roll (side to side), but the pitch becomes larger during time of increased wave energy.

4.3.1.3 Mooring Line

The type of load, rope material, ease of handling, duration of deployment and the surrounding environment are components that are worth considering when choosing a mooring line. Different rope materials have different properties: Strength, drag, stretch, endurance, weight, and floating / sinking capacity.

When determining the design of a mooring in the deep ocean, the drag on the mooring line over the entire length is an important factor. As a starting point, it is a good idea to choose the mooring line with the smallest diameter possible to avoid excessive drag. The diameter represents the largest portion of overall drag contributions due to the large cross-sectional area (A in Equation (1)) of the long line. Shallow water moorings, on the other hand, are subject to currents that outweighs the contribution from the diameter of the mooring line; the tidal, wind and wave-induced currents (V^2) in Equation (1) are the factors that should be of primary interest when choosing mooring line. E.g. a heavier sinker may be required to hold the mooring in position because there will be more tendency for the buoy to lift the anchor under rough sea conditions.

The stretch or amount of elongation of the line will determine the location of the instrument and the surface buoy at any time. When considering a deep-water mooring, the objective of keeping the mooring line taut is adapted by using elastic synthetic rope. The elastic stretching of the rope reduces the effect of instrument movement due to currents and waves, and it may not pull the surface buoy under the surface. Under adverse environmental conditions (excessive wind and waves), the energy of the movement of a surface buoy can be absorbed by the elasticity of the rope. Note that the elasticity of a synthetic rope is non-linear and changes with time. Several hundred meters of mooring line may be required for full ocean depth (>1000 m) mooring, so the weight of the line itself is not negligible. Use of

elastic synthetic rope in shallow water is usually not recommended due to the short length that one would have to use (in order to avoid wearing from the bottom). An alternative is to use floats along the line to keep the mooring off the bottom. Note that synthetic ropes are made of visco-elastic materials, so their stiffness characteristics are not constant and vary with the duration of load application, the load magnitude and number of cycles. In general, synthetic mooring lines become stiffer after long use.

Avoid knots on the rope, as this reduces the breaking strength with up to 50%.

4.3.1.4 Anchor

The ability of an anchor to hold a position on the seafloor is dependent on several factors; the seabed type, the anchor material, shape and weight. Failure of the anchor can have serious effects on the deployment.

Primarily, the anchor weight must be sufficient. It is essential to have enough weight on the bottom of the mooring to allow the assembly to sink and remain firmly at the sea floor. It must be able to withstand any vertical and horizontal tension that may be placed on it. With an anchor that weights too little, the mooring system might shift location during e.g. high tide or high current situations. On the other hand, the anchor size and weight must be kept within reason due to ease of deployment. The site condition is also an important factor when determining the anchor weight.

Generally, the more cohesive the bottom type, the more horizontal friction there is between the anchor and the bottom, the more force is required to move the anchor. Soft bottoms will generally have more holding force than rocks, gravel or shells. The shape of the anchor will help increase the holding power of the anchor.

The density of the anchor material is critical due to the loss of weight that materials experience when fully submerged. For example, the weight of submerged concrete is only 56% of dry land weight. Because the reduced weight of concrete anchors, larger sizes may be needed to achieve the desired weight.

When using an acoustic release, the anchor is abandoned at the seafloor, thus it should be able to disintegrate after a certain amount of time so that it is not an obstruction to others. Another benefit of an anchor that disintegrates is that the system will eventually refloat if e.g. the acoustic release should fail.

Dead weight anchor: The dead weight anchor (illustrated in Figure above) is used to resist vertical pull of the system; some weight underneath the instrument will keep it from bouncing around in rough weather. A length of chain is recommended due to the reduced chance of sidelobe interference compared to when using weight with a larger surface area. Ballast underneath the surface buoy has the same effect, and the risk of entanglement of the mooring line is reduced. A length of chain placed above the anchor will reduce the tension the anchor experiences.



Figure: Illustration of use of dead weight anchor

4.3.1.5 Connecting Hardware

Shackles, swivels and links are used to connect the different components of the mooring and to secure the instrument in line. The strength required to resist the tension from the different components it connects is the important factor when choosing dimensions. Remember that a mooring is only as strong as its weakest link.

Swivels are sometimes inserted to permit rotation of one of the two components it connects, as this helps reducing the torsion stress on the line.

Another aspect to focus on is to avoid contact between metals/alloys of different qualities to the greatest extent possible. By doing this, the possibility of corrosion is reduced. For example, the battery canister should be isolated from any other metals to avoid the risk of corrosion and canister failure - use nylon washers, plastic sheeting, etc.

Note that the shackles must be secured with a safety pin. Remember that the safety pin must also be of corrosion resistant material to not contribute to increased corrosion of the shackles. Do not mix metals.

4.3.1.6 Bottom Frame

When designing or selecting a bottom frame, you should consider a few things before you drop your gear in the water.

Stability. The frame should sit on the bottom and not move or rock back and forth. One common solution is to use a tripod leg configuration. Stability naturally improves with a larger frame "footprint" and a lower profile. The frame will normally have the battery canister on one of the legs. If possible, put the battery inside the leg, and not outside. Have an equal amount of weight on each side / leg; the frame might tip over if the weight is too little and / or uneven. Make sure that the weight is correct underwater.

Mobility. Clearly, the frame should not move while on the bottom. Movement can come from strong mean currents or wave generated currents. Wave generated currents can be particularly troublesome in shallow waters or environments where waves are large and long. The frame must also be firmly attached to the bottom if the bottom type is relatively soft. Note that shifting sediment or sand can undermine bottom fasteners.

Ease of deployment. This should be considered if the frame is to be deployed by divers or handled by a small boat. If a large amount of weight is used to eliminate mobility, it may not be manageable by a small boat or crew.

Orientation. The instrument should be placed vertically and in the case of the AWAC, with AST, a tilt less than 5 degrees should be the aim. For other instruments, the performance deteriorates quickly for tilts greater than 10 degrees. A gimbal is the best solution if you do not use divers to ensure the proper orientation of your frame / instrument.

Retrieval. This is perhaps more of a deployment consideration; however, some method should be kept in mind for a retrieval system that does not interfere with the instrument's performance. Surface buoys floating above the instrument can interfere with the acoustic beams; moreover, they may be dragged away or lost due to shipping traffic or curious mariners. Alternative methods of retrieval include acoustic releases (from bottom weight), pop up buoys with releases, drag lines and/or offset mooring systems.

Trawl resistance. Bottom fishing is perhaps one of the most challenging issues for bottom-mounted systems. Trawl resistant bottom frames are designed for protecting the instruments from trawler gear. The frames can reduce the risk of being impacted by trawlers, but the risk is not completely eliminated. A good alternative is the [Miniaturized Trawl Resistant Bottom Mount \(MTRBM\) systems](#).

Multi-sensor mounting. Since Nortek instruments provide the possibility to integrate external sensors, this should be considered when deciding on a frame.

Ease of shipping. Some frames can be separated into sections for easy shipping. This of course reduces operational costs when testing is performed at different locations.

Corrosion resistance. All materials of the frame must be corrosion resistant. Materials such as fiberglass, stainless steel (316), aluminum, and plastic are good alternatives. You must always isolate any metal you use, and make sure not to mix metals to reduce the risk of corrosion.

Burial. This is also a challenging issue for bottom-mounted instruments. Low profile frames may not be the best alternative in locations with large sediment deposits or moving sand. Sometimes it is just a matter of time before the frame slowly sinks or sand builds up; in these situations, some users (of online systems only) have found sensors measuring distance from the instrument to the bottom useful. If mean currents and wave-induced currents are manageable at the bottom, a solution against burial is to mount the instrument on a subsurface buoy located just above the bottom.

Magnetic deviation in the instrument compass due to a magnetic source on the bottom frame should be taken into account by calibrating the compass before deployment (for more on this, read the Service Manual).

4.3.2 Ancillary Equipment

4.3.2.1 Pop-up Buoy

The pop-up buoy is recommended when use of a surface buoy is impractical. Most of the pop-up buoy's life is spent submerged, secure from storms and surface traffic. It functions by attaching one end of a line to e.g. the bottom frame and the other end to the buoy. Upon receiving an acoustic command, the buoy rises to the surface and works as a surface signature, and the line attached to the buoy can be used to pull up the equipment directly. The Spin buoy by Abyssus, the Fiobuoy by Fiomarine and the 875-PUB by Benthos are good alternatives. Make sure to obey the depth limitations specified by the manufacturer.

4.3.2.2 Acoustic Release

An acoustic release system is deployed in-line on a mooring, close to the anchor. When activated from the surface unit, the release system disconnects from the anchor, and the mooring system ascends to the surface. Note that it is important to have enough buoyancy close to the bottom and / or along the mooring line to make sure the system reaches the surface.

4.3.2.3 Gimbal

On an uneven sea floor, a gimbal provides proper orientation of the transducer head. Since a gimbal uses gravity to keep the instrument upright, it is necessary to have a counter weight underneath the instrument. This is particularly important for the AWAC since it is "top heavy". Make sure there is

enough space below the instrument's gimbal; an uneven bottom or settling frames will have reduced clearance and could cause the gimballed instrument to tilt. A gimbal should not be used in combination with an open bottom frame in areas with high currents, as the gimbal then might work counterproductive, leading to more tilt.

4.3.3 Mounting Device

4.3.3.1 AquaFin

Nortek's AquaFin optimizes the instrument's ability to measure without flow disturbance while simplifying in-line deployment. The AquaFin shackles in-line and swivels the instrument so that its beams always face into undisturbed flow. In this context, it is especially useful to use swivels instead of shackles, as mentioned earlier. The instrument's compass has no trouble compensating for the heading changes. The AquaFin works equally well for the Aquadopp and the AquaPro.

4.3.3.2 AquaClamp

The AquaClamp is similar to the AquaFin in that it is used to mount an Aquadopp current meter or profiler on a mooring line. The AquaClamp mounts in-line in the mooring line, and it is used when clamping the instrument directly to the mooring line is not practical or desired.

4.4 Special Considerations

4.4.1 Measuring Waves

Refer to the Principles of Operation, Part II for in-depth explanation of wave and wave processing methods. The most important things to consider regarding deployment of instruments measuring waves are the focus here.

What considerations that must be taken into account first and foremost depend on the wave frequency of interest, and on what processing method that can / will be used. Knowledge about the limitations that exists when measuring waves and having an anticipation of the waves that are to be captured is critical to determine the instrument's depth and ultimately successful data collection and post-processing. Therefore the aim is to achieve a "Target Depth". This is the deployment depth that will capture as much of the wave spectrum as possible with the greatest amount of accuracy. Knowing the types of waves the instrument is likely to be exposed to, and what types of waves that are of interest to measure, makes it much easier to decide upon the deployment depth.

PUV method: Pressure, U and V velocity components (orbital velocity components) are the parameters of interest. The pressure and orbital velocity signals attenuate with depth, thus the signals from the waves are not detectable at a certain depth. If you know the significant wave height of the area and the prevailing period of the waves, you can find the depth in the table above that are able to measure the waves of interest. This table provides a general guideline for the limitations when measuring waves.

Perhaps the most difficult aspect of classifying sea state via spectral based estimation is the realization of wave energy at high frequencies. These types of spectra prove to be quite tricky. Amongst the problems are the errors in the calculation of moments and cutting off peaks at higher frequency. One scenario is that an instrument placed in 15 meters of water may never detect the energy up above 0.25 Hz.

Array method: The difference between PUV and the Array method is that the latter measure U and V closer to the surface with the consequence that shorter waves can be measured. The pressure is measured at the level of the instrument. The measurement of U and V are still limited by the frequency of the waves; as the deployment depth becomes greater, so does the horizontal separation between individual measurement cells in the surface array. In order to resolve wave direction at any given frequency, the horizontal separation of individual measurements must be less than half a wave length.

This aliasing presents a spatial Nyquist limit and leads to a “cutoff frequency” where wave directions cannot be resolved. For example, a gauge deployed 40 m below the surface has a directional cutoff frequency of about 0.23 Hz, that is, a period of 4.35 seconds (cf. Table below). This means the gauge will not be able to resolve directions from waves shorter than 4.35 seconds at 40 m depth.

Depth	Cutoff freq.	Cutoff T
5	0.7	1.45
10	0.45	2.2
20	0.32	3.1
30	0.26	3.85
40	0.23	4.35
50	0.20	5.0
60	0.18	5.5

Table: Limitations of the measurable waves (Array method) with regard to depth, cutoff frequency [Hz] and period, T, [s].

MLMST and SUV method: The same limitations of measuring U and V velocities using the Array method applies to the MLMST and SUV. The MLMST and SUV methods use the AST to measure wave energy; a method that is often more accurate because it is a direct measurement of the surface position, as opposed to the inferred pressure. The wave resolution from the AST measurements is not completely independent of deployment depth either; some high frequency wave information is lost at greater deployment depths. This limit has to do with the size of the AST footprint on the sea surface relative to the measurable wavelength. The size of this circular footprint is determined by (a) the beam width and (b) the distance from the sea surface. The size of the footprint will increase with wider beam width or with greater distance from the sea surface. The difference between MLMST and SUV is that the latter permits the instrument to rotate during the wave burst (i.e. instrument mounted on a subsurface buoy), while the MLMST method depends on measurements retrieved from a not-moving instrument.

4.4.2 Natural Frequency of Subsurface Buoys

Each subsurface buoy has its own characteristic response. For instruments mounted in a subsurface buoy, this motion may contaminate the collected velocity data. The characteristic response is based on several design parameters, such as mass, buoyancy, drag and mooring line length. Balancing the forces on the buoy, given a nominal displacement from equilibrium, results in a simple, linearized differential equation of motion. This can be used to estimate the natural frequency of a subsurface buoy to first order as follows:

$$(4) \quad \omega_n = \sqrt{\frac{R}{ML}}$$

$$(5) \quad T = \frac{2\pi}{\omega_n}$$

$$(6) \quad R = F_B g$$

$$(7) \quad M = M_{buoy} + M_{added}$$

ω_n is the natural frequency of the mooring system, T is the corresponding period of oscillation, L is the mooring line length, R is the cable tension of the mooring (restoring force), F_B is the buoyancy in mass units [kg], and M is the mass of the buoy itself plus the mass added to the buoy (the mass of the instrument).

The idealized motion of subsurface buoys most closely resembles an inverted pendulum. Once displaced, the mooring system returns to its equilibrium position, swinging back and forth at its unique natural frequency, thus creating an apparent velocity in the velocity measurement cells. The most likely explanation for possible false velocities, and thus poor directional performance (increased directional uncertainty in the wave measurements) at certain periods, is that the buoy is being displaced from its equilibrium position with wave energy at other frequencies. During periods of low energy the associated wave orbital velocities have decreased amplitude and therefore are more vulnerable to sources of noise.

It is important to get a good understanding of the expected motion of the subsurface buoy to ensure that the response of the buoy has a natural frequency outside of the dominate wave frequency when collecting data. To avoid that the natural frequency and the wave frequency are in the same band, the design of the mooring should be carefully considered. Each term in equation (4) has a certain significance, but the term that can easily be adjusted to contribute to a higher or lower natural frequency is the length of the mooring line (L). The natural frequency decreases with increasing L . Thus, if the calculated frequency is too high / low, one can extend / shorten the length of the mooring line. One may also consider the buoyancy of the system and the total mass.

4.4.3 Damping Factor

The damping factor (ξ) can be calculated to make an indication of the potential for resonant behavior at the system natural frequency. The damping factor ξ is defined as:

$$(8) \quad \xi = \frac{D}{2M} \sqrt{\frac{ML}{R}}$$

Here, D is a coefficient defined by the buoy drag coefficient, cross sectional area and water density, M is the mass term described earlier, R is the reserve buoyancy, and L is the mooring line length.

An overdamped system is defined as $\xi > 1$ and returns to its equilibrium position without overshoot; no free oscillations are possible, even at the system's natural frequency. An underdamped system has a $\xi < 1$, and suggests a system capable of overshoot oscillations (e.g. when disturbed can sway back and forth through multiple cycles before returning to rest). Underdamped systems experience resonant motions if the external forcing, in this case waves, occurs at the system's natural frequency. While both

over- and underdamped systems respond to wave forcing across the spectrum, the underdamped system is the most troublesome since it can create persistent artificial velocities at the natural frequency of motion. One should thus focus on designing the system to be overdamped.

4.4.4 Mooring Vibrations

High frequency mooring vibrations due to vortex shedding are caused by current flow past a mooring structure, such as surface and subsurface buoys, mooring lines, risers etc. Alternating vortex shedding produces pressure fluctuations with a dominant component in the direction across the flow direction. The mooring structures, if not mounted rigidly, are very sensitive to excitation from vortex shedding, especially if the frequency of vortex shedding matches the resonance frequency of the structure. This results in resonant vibrations transverse to the flow direction of the ocean currents. The occurrence of vortex induced motion also increases the mean drag force in the current direction, contributing to aggravating the data collection. Increased offset implies increased mooring line tensions. It also causes oscillations in the line tension, which may contribute to fatigue damage.

Excessive mooring vibration can adversely affect the data; vibration introduces spurious velocities and interferes with the proper operation of the tilt sensor. The impact of mooring oscillations must be carefully considered. A general solution to improve on data quality is to design a more stable deployment by considering the components that generate mooring vibrations. The addition of aerodynamic devices may partly prevent and partly reduce the strength of vortex induced vibrations. You may be able to detect intervals of excessive vibration by looking closely at your data. For more accurate measurements of vibration, an accelerometer is the solution.

4.4.5 Corrosion

Corrosion is a big risk to your deployment if the proper steps are not taking to prevent it. Avoid mixing metals by isolating clamps, shackles, battery canisters, etc. Make sure battery canisters have a zinc anode attached.

4.5 Check lists

BOTTOM MOUNT

PLANNING THE DEPLOYMENT

- One of the first aspects to consider is the environment the instrument is to be deployed in. The location, the influence from the surroundings, and most importantly the prevailing wind-, wave-, current- and tide conditions are essential to consider when preparing a successful deployment and hence making as accurate measurements as possible.
- The Compass Update Rate (accessible in the *Deployment Planning* pane) should be adjusted to the current conditions in the area and the chosen mounting method. For a bottom mount, one update per burst is enough.
- The Instrument should be oriented vertically; the performance deteriorates quickly for tilts greater than 20°. When using AWAC AST, a tilt within 5° of the vertical should be aimed. A gimbal is the best solution (if you do not use divers) to ensure the proper orientation. Since a gimbal uses gravity to keep the instrument upright, it is necessary to have enough *counter weight* underneath the instrument. Note that the gimbal may counterproductive during strong currents.
- Large waves generate orbital currents down to a certain depth, thus the mounting frame may be exposed to strong forces. The frame should thus be compact at the same time as it should be heavy. Note that the frame might tip over if the weight is too little/unevenly distributed.
- A quick calculation of the forces at work, such as buoyancy, tension and drag, is useful as a verification of the stability of the deployment.
- Do not mix parts of different metal quality. Corrosion resistant material should be used; fiberglass, stainless steel (316), aluminum, and plastic are good alternatives.

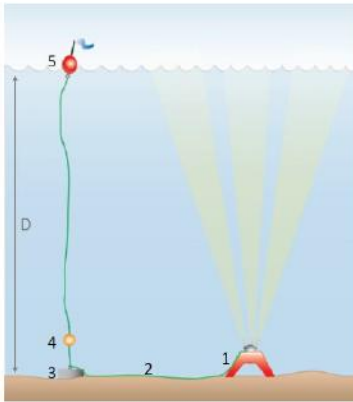

ILLUSTRATION OF A DEPLOYMENT

1. The bottom frame (here: *Ocean Science Sea Spider*). Remember enough weight to prevent the frame from moving or rocking back and forth.
2. The distance between the bottom frame and the concrete anchor should be equal to the depth (D) for easier hoist when retrieving the system. Type of mooring line should be chosen wisely, certain wire types do stretch under tension. In addition, the current velocity at the area should affect the choice of diameter of the mooring line; the thinnest possible mooring line should be used (to reduce drag).
3. The dimension and weight of the concrete anchor must be adjusted to the conditions at the location; in addition it must be resistant to the oceans dissolving impact. Remember that the buoyancy of the anchor is equal to the volume of water it displaces.
4. Subsurface buoy above the anchor, to prevent the slack mooring line to rub against the bottom.
5. Retrieval buoy / surface signature. An alternative is using an acoustic release system, sending a pop-up-buoy to the surface at command.

FINAL CHECK LIST

- Make sure you are using the most recent software and firmware for your instrument.
- The Functional Test in the Quick Guide is performed.
- The battery is connected.
- The battery and memory requirements are met (cf. the *Deployment Planning* pane).
- The desiccant bag is replaced (if necessary).
- There are no obstructions between the beams and the measurement area.
- The compass alignment is verified.
- The pressure sensor offset is set.
- The flow disturbance is considered. No other instrument or other parts of the mounting are causing turbulence.
- The mooring tilt does not exceed 20°. When using AWAC AST, the tilt should be within 5° of the vertical.
- The dummy plug(s) is installed.

SUBSURFACE BUOY

PLANNING THE DEPLOYMENT

- One of the first aspects to consider is the environment the instrument is to be deployed in. The location, the influence from the surroundings, and most importantly the prevailing wind-, wave-, current- and tide conditions are essential to consider when preparing a successful deployment and hence making as accurate measurements as possible.
- The Compass Update Rate (accessible in the *Deployment Planning* pane) should be adjusted to the current conditions in the area and the chosen mounting method. Recommended compass update rate when using a subsurface buoy is one update per second.
- The mooring's characteristic response should not fall in the wave band of interest. This can be controlled by considering primarily the buoyancy of the subsurface buoy and the length of the mooring line, but parameters such as mass and drag also have an effect. The natural frequency of the buoy should be below 0.03 Hz (outside the dominant wave frequency). It is recommended to read more about this in the *Mounting Guideline*.
- Do not mix parts of different metal quality. Corrosion resistant material should be used; fiberglass, stainless steel (316), aluminum, and plastic are good alternatives.
- A quick calculation of the forces at work, such as buoyancy, tension and drag, is useful as a verification of the stability of the deployment.

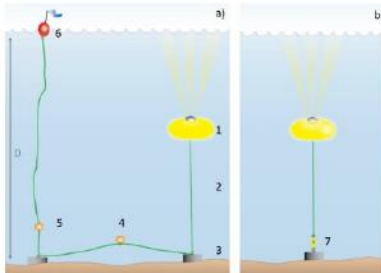

Figure 1: a) is suited for shallow deployments; b) can be used at every depth, provided that the depth capability of the acoustic release (5) or the instrument is not exceeded.

ILLUSTRATION OF A DEPLOYMENT

1. Subsurface float with instrument mounted inside. It is essential that this subsurface float has sufficient buoyancy to avoid tilt of the instrument. Note that an ellipsoid shaped buoy has lower drag than a spherical buoy.
2. The position of the subsurface buoy is equal to $D - 2$. The type of mooring line should be chosen wisely, certain wire types do stretch under tension. In addition, the current velocity at the area should affect the choice of diameter of the mooring line; due to drag, the thinnest possible mooring line should be used.
3. The dimension and weight of the concrete anchor must be adjusted to the conditions at the location; in addition it must be resistant to the oceans dissolving impact. Remember that the buoyancy is equal to the volume of water the anchor displaces.
4. The distance between the two concrete anchors should be equal to the depth (D), for easier hoist when retrieving the system. A subsurface buoy along the line will make it easier to catch the line if it is lifted off the bottom by the buoy compared to when it is resting along the bottom, as a backup.
5. Subsurface buoy, to prevent the slack line to rub against the bottom.
6. Retrieval buoy / surface signature.
7. Acoustic release. The anchor will be abandoned at the sea floor and should thus disintegrate, so that it does not end up as an obstacle for e.g. trawlers. In addition, the instrument will eventually refloat if the acoustic release should fail (backup recovery).

FINAL CHECK LIST

- Make sure you are using the most recent software and firmware for your instrument.
- The Functional Test in the Quick Guide is performed.
- The battery is connected.
- The battery and memory requirements are met (cf. the *Deployment Planning* pane).
- The desiccant bag is replaced (if necessary).
- There are no obstructions between the beams and the measurement volume.
- The compass alignment is verified.
- The pressure sensor offset is set.
- The flow disturbance is considered. No other instrument or other parts of the mounting are causing turbulence.
- The mooring tilt does not exceed 20°. When using AWAC AST, the tilt should be within 5° of the vertical.
- The dummy plug(s) is installed.

IN-LINE MOORING, INSTRUMENT POINTING UPWARD

PLANNING THE DEPLOYMENT

- One of the first aspects to consider is the environment the instrument is to be deployed in. The location, the influence from the surroundings, and most importantly the prevailing wind-, wave-, current- and tide conditions are essential to consider when preparing a successful deployment and hence making as accurate measurements as possible.
- The Compass Update Rate (accessible in the *Deployment Planning* pane) should be adjusted to the current conditions in the area and the chosen mounting method. Recommended compass update rate for an instrument on a mooring line is every other second.
- Attach the instrument to the mooring line by using e.g. Aquafin or AquaClamp (visit <http://nortek-as.com/en/service/deployment-assesories> for more information). Make sure the Instrument's x-axis (marked at the head of the instrument) points out of the frame.
- When mounting more than one instrument on the mooring line, the instruments should transmit signals out of step with each other to avoid interference.
- Do not mix parts of different metal quality. Corrosion resistant material should be used; fiberglass, stainless steel (316), aluminum, and plastic are good alternatives.
- A quick calculation of the forces at work, such as buoyancy, tension and drag, is useful as a verification of the stability of the deployment.

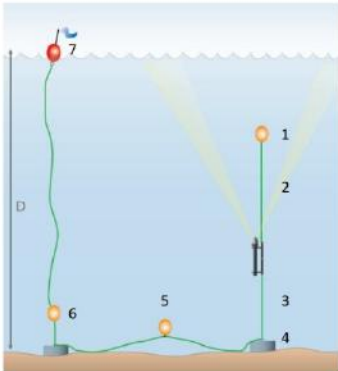

ILLUSTRATION OF A DEPLOYMENT

1. Buoy to keep the instrument in a vertical position. It is essential that this subsurface float has sufficient buoyancy to avoid tilt of the instrument.
2. Minimum distance between the instrument and the buoy (1) should be 10 m to avoid Sidelobe interference. Note that in case of few particles in the water, the data might be contaminated by the Sidelobe interference in spite of 10 m clearance.
3. The deployment depth is equal to $D - 3$. The thinnest possible mooring line should be used to avoid tilt due to drag.
4. The dimension and weight of the concrete anchor must be adjusted to the conditions at the location; in addition it must be resistant to the oceans dissolving impact. Remember that the buoyancy is equal to the volume of water the anchor displaces.
5. The distance between the two anchors should be equal to the depth (D) for easier hoist when retrieving the system. A subsurface buoy along the line will make it easier to catch the line if it is lifted off the bottom by the buoy compared to when it is resting along the bottom, as a backup.
6. Subsurface buoy, to prevent the slack line to rub against the bottom.
7. Retrieval buoy / surface signature.

Note: An acoustic release is an option if this is to be deployed at greater depths.

FINAL CHECK LIST

- Make sure you are using the most recent software and firmware for your instrument.
- The Functional Test in the Quick Guide is performed.
- The battery is connected.
- The battery and memory requirements are met (cf. the Deployment Planning pane).
- The desiccant bag is replaced (if necessary).
- There are no obstructions between the beams and the measurement volume.
- The compass alignment is verified.
- The pressure sensor offset is set.
- The flow disturbance is considered. No other instrument or other parts of the mounting are causing turbulence.
- The mooring tilt does not exceed 20°.
- The dummy plug(s) is installed.

IN-LINE MOORING, INSTRUMENT POINTING DOWNWARD

PLANNING THE DEPLOYMENT

- One of the first aspects to consider is the environment the instrument is to be deployed in. The location, the influence from the surroundings, and most importantly the prevailing wind-, wave-, current- and tide conditions are essential to consider when preparing a successful deployment and hence making as accurate measurements as possible.
- The Compass Update Rate (accessible in the *Deployment Planning* pane) should be adjusted to the current conditions in the area and the chosen mounting method. Recommended compass update rate for an instrument attached to a mooring line is every other second.
- Attach the instrument to the mooring line by using e.g. Aquafin or AquaClamp (Check the Mounting Guideline for more information, or visit <http://nortek-as.com/en/service/deployment-assesories>).
- When mounting more than one instrument on the mooring line, the instruments should transmit signals out of step with each other, to avoid interference.
- A quick calculation of the forces at work, such as buoyancy, tension and drag, is useful as a verification of the stability of the deployment.
- Do not mix parts of different metal quality. Corrosion resistant material should be used; fiberglass, stainless steel (316), aluminum, and plastic are good alternatives.

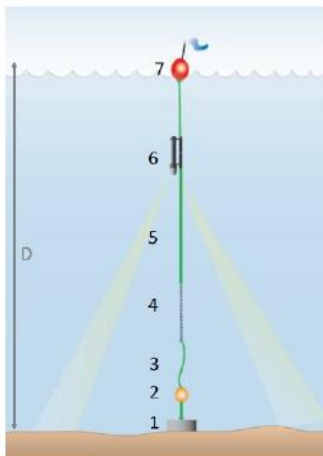

ILLUSTRATION OF A DEPLOYMENT

1. The dimension and weight of the concrete anchor must be adjusted to the conditions at the location; in addition it must be resistant to the oceans dissolving impact. Remember that the buoyancy is equal to the volume of water the anchor displaces.
2. Subsurface buoy, to prevent the slack line (3) to rub against the bottom.
3. Slack corresponding to maximum tidal effect, to prevent the system from moving to another location during maximum tide.
4. A type of ballast (here: chain) to keep the instrument in a vertical position. The advantage of using a chain is that it has a small surface area (seen from above) and will thus not contribute to reflect the signals transmitted from the instrument.
5. The thinnest possible mooring line should be used to avoid tilt due to drag.
6. Make sure the instrument's x-axis (marked at the head of the instrument) points out of the frame. The quality of the measurements will be destroyed if the beams "see" the ropes.
7. Retrieval buoy / surface signature.

FINAL CHECK LIST

- Make sure you are using the most recent software and firmware for your instrument.
- The Functional Test in the Quick Guide is performed.
- The battery is connected.
- The battery and memory requirements are met (cf. the Deployment Planning pane).
- The desiccant bag is replaced (if necessary).
- There are no obstructions between the beams and the measurement volume.
- The compass alignment is verified.
- The pressure sensor offset is set.
- The flow disturbance is considered. No other instrument or other parts of the mounting are causing turbulence.
- The mooring tilt does not exceed 20°.
- The dummy plug(s) is installed.

ONLINE MODE, BOTTOM MOUNT AND OFFSHORE CABLE

An **Offshore Cable** is suitable for providing power and communication to instruments located at distances of up to 5 kilometers off the coast. For cables longer than 50 m the online cable connects on shore to an Interface Box, which supplies 48 VDC power and RS-422 communication. To reduce the voltage sent in to the electronics of the instrument, a DC-DC converter (mounted inside the instrument) is required. When planning a deployment, consider the following factors:

- The Compass Update Rate (accessible in the *Deployment Planning* pane) should be adjusted to the current conditions in the area and the chosen mounting method. For a bottom mounted deployment, one update per burst is enough.
- The instrument should be placed vertically; the performance deteriorates quickly for tilts greater than 20°. When using AWAC AST, a tilt within 5° of the vertical should be aimed. A gimbal is the best solution if you do not use divers to ensure the proper orientation. Since a gimbal uses gravity to keep the instrument upright, it is necessary to have enough *counter weight* underneath the instrument.
- Large waves generate orbital currents down to a certain depth, thus the mounting frame will be exposed to strong forces. The frame should thus be compact at the same time as it should be heavy. Note that the frame might tip over if the weight is too little/unevenly distributed.
- To simplify the problem of wear and tear, we recommend a segmented cable where the segments are linked with an underwater mate-able connector that can be detached or attached by a diver (optional diver tool is available).
- Do not mix parts of different metal quality. Corrosion resistant material should be used; fiberglass, stainless steel (316), aluminum, and plastic are good alternatives.

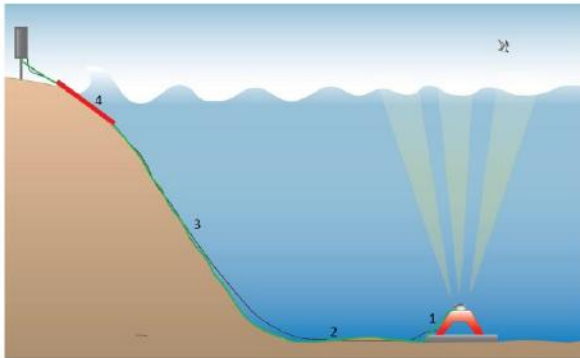

ILLUSTRATION OF A DEPLOYMENT

1. The bottom frame (here: *Ocean Science Sea Spider*). Remember enough weight to prevent the frame from moving or rocking back and forth.
2. Make sure that the cable rests at the bottom (not stretched) when lowering the cable from a boat.
3. Secure the cable at the seabed, or bury it completely. This is important in order to reduce the exposure of a cable.
4. In the surf zone, you should protect the cable by using a plastic tube bolted to the ground, encapsulating the cable.

FINAL CHECK LIST

- Make sure you are using the most recent software and firmware for your instrument.
- The Functional Test in the Quick Guide is performed.
- The battery is connected.
- The battery and memory requirements are met (cf. the *Deployment Planning* pane).
- The desiccant bag is replaced (if necessary).
- There are no obstructions between the beams and the measurement volume.
- The compass alignment is verified.
- The pressure sensor offset is set.
- The flow disturbance is considered. No other instrument or other parts of the mounting are causing turbulence.
- The mooring tilt does not exceed 20°. When using AWAC AST, the tilt should be within 5° of the vertical.
- The dummy plug(s) is installed.

System Integrator - Light

SECTION

5

5 System Integrator - Light

This section covers analog inputs and outputs, i.e. how to use Nortek instruments together with other instruments.

For a more comprehensive System Integrator Manual, check out the one available on [our support site](#). This manual provides the information needed to control a Nortek product with a non-PC controller. It is aimed at system integrators and engineers with interfacing experience.

5.1 Analog Inputs

You may connect external sensors to the two analog inputs of most Nortek instruments. They may be powered (enable this in the Deployment Planning dialog), and their data output may be stored in the instrument during a deployment or downloaded in real time. The instrument can read both analog inputs at the same time.

The reported value from the Nortek instrument is counts. The scaling is $V = (\text{Counts}/65536)*5$ due to 16 bit AD converter. The input range is 0-5 Volt, where 0 Volt equals 0 counts, 5 Volts equals 65535 counts and 2.5 Volts equals 32768 counts.

The analog input can be scaled and re-labeled in the instrument specific software; Click View > Analog Inputs.

Power out can be software selected by sending a HEX command in a terminal emulator.

Voltage Level	Command	Maximum Current
RAW	OPWRBA	500 mA
+12 V	OPWR12	100 mA
+5 V	OPWR5V	250 mA

Be aware that the power out is turned off when the instrument is in sleep mode, as this contributes to reducing the system's power consumption significantly. Consequently, the external sensor used must be capable of automatically resuming its duties once the power comes back and it must do this within 1 sec after power up in order to provide correct data for the first sample. Please be aware that

- Power at 5 and 12 VDC comes through switching regulators. This means that power drawn from the battery pack is 15-18% greater than the power consumed by the external device. See example in the next section when considering energy consumption.
- The output voltage is protected against short-circuit with a 1-amp fuse. To protect the circuitry against external sensors providing an output voltage in excess of +5.0V, there is a clamping diode on the input with a current limiting resistor in series. The diode will conduct at voltages above approximately 5.3V. To achieve stable conditions during testing, the +5V_SEN net can be powered up from command mode by sending the hex command 435001C4.
- The output voltage turns on at least 0.8 s before the beginning of a measurement interval, and it turns off again at the end. The first measurement of the analog inputs occurs roughly 0.9 s after power is applied.

- The planning software does not consider power consumption of your external devices when it plans deployments.
- The data from the external sensor will not be affected by the instrument data quality. For example, the external sensor's data will be totally unaffected even if the instrument is out of water and thus measuring noise only.
- The input impedance of the analogue inputs is 468 k Ω /100 nF

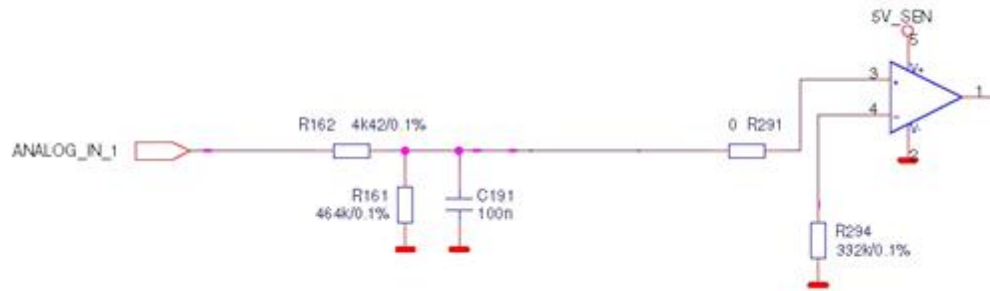

To activate powering of the external sensor:

- In the instrument software click Deployment > Planning > Use existing or use Load from Instrument.
- Check the “Use Advanced Settings” box and go to the Advanced tab.
- Define which analog input (1, 2 or both) to use. AquaPro: Profile is used to sample data at the same rate as profile measurements are started, while Wavesample is every time a wave burst measurement is started. The Profile & Wave is used to sample data every time a profile or a wave burst measurement is started. Only one of the inputs can be set to sample while wave measurements are made. A warning will appear if you attempt to set them both to wave related sampling. AWAC: The difference from the AquaPro is that Wave samples every time an AST wave measurement is started. The Profile & Wave is used to sample data every time a profile or an AST wave measurement is started.

If you want to power the external sensor from the instrument you must check the Output power box. The output power is configured in hardware by Nortek and can be raw (i.e. battery power), +5 V, or +12 V (c.f. table above). The raw setting is the default setting and all instruments come with this setting unless otherwise was specified upon ordering.

5.1.1 Example of Calculation of Energy Consumption

If you are interested in calculating energy consumption, the following example might be helpful. It covers the energy consumption of an OBS3+ sensor, 15 mA, 5-15V supply, that are set up for 30 days deployment.

Duty cycle of OBS: (2048samples/4Hz)/1200sec measurement interval = 43%.

Output power voltage set to battery: $11V \cdot 15mA \cdot 43\% = 71mW$ per sensor. Energy per sensor: $30days \cdot 24hours \cdot 0.071W = 51 Wh$. That is 102 Wh for two OBS sensors.

Output power voltage set to 12V: $1.25 \cdot 12V \cdot 15mA \cdot 43\% = 97 mW$ per sensor. Energy per sensor: $30days \cdot 24hours \cdot 0.097W = 70 Wh$. That is 140 Wh for two OBS sensors.

Output power voltage set to 5V: $1.25 \cdot 5V \cdot 15mA \cdot 43\% = 40mW$ per sensor. Energy per sensor: $30days \cdot 24hours \cdot 0.040W = 29 Wh$. That is 58 Wh for two OBS sensors.

5.2 Analog Outputs

The Aquadopp has the option of outputting data analog represented. They are able to output the measured velocities on a linear scale, and the voltage output is 0-5 volt. This voltage must manually be converted to velocities. 0 m/s is reported as 2.5V, -velocity range as 0V and +velocity range as 5V. Available outputs are 3 velocities (E/X/B1 N/Y/B2 U/Z/B3) and pressure. For standard cable only 3 outputs are available – 3 velocities are default.

The velocity is given by:

$$(vel_{range}/V_{range}) \times V_{out} = velocity$$

Where vel_{range} = full range of velocity, V_{range} = usually 0V to 5V, V_{out} = voltage outputted, vel_{min} = minimum velocity.

Example:

The range is specified to +/- 1m/s

Voltage outputted is 1V

V_{range} is 5V

The velocity would be: $(2/5V) * 1V - 1m/s = -0.6m/s$

Alternatively set up two equations (2 unknowns, slope and intercept) using $mx + b = y$, where x is voltage and y is velocity. Knowing voltage and velocity in two scenarios will give m and b (use max and min velocity and voltage). This gives you the full linear fit.

At zero flow the outputted voltage should display 2.5V. If not, there may be issues with grounding.

Note: To use this function Nortek needs to provide a head file with this enabled. The correct harness also needs to be installed.

5.2.1 Aquadopp Current Meters

Aquadopps can send out velocity and pressure signals as 0-5 VDC analog voltages. Here is what is required to enable analog outputs:

- A special wiring harness passes the analog voltages out to the external connector. The output wires include three signal wires and one ground wire (which is shared with the RS232 ground). The remaining wires are allocated to RS232 and power.
- A special head configuration file where analog outputs are enabled is needed.
- An Aquadopp can send three velocity channels or two velocity channels plus pressure. The selection of output channel is controlled by firmware. The most common configuration combines the two velocities with pressure to measure directional wave data.
- Aquadopp software controls how the data are collected, including specifically sample interval and coordinate system (ENU, XYZ or beam)
- Aquadopp data output is normally limited to 1 Hz, but special firmware is available to output signals at 4 Hz.

- Once in analog output mode, you can remove and reapply power as desired. When you reapply power, the analog outputs resume. Allow a few seconds for the instrument to start up after you apply power.

Troubleshooting Guide

SECTION

6

6 Troubleshooting Guide

This section covers:

- ✓ Tests that can be performed if you encounter a problem
- ✓ What to do if your data does not look right
- ✓ Instructions on how to return an instrument for repair

This document contains our yearlong experience in where to start looking if an instrument does not behave as intended. If you encounter a problem, you should:

- Work in a systematic way and do not neglect the obvious.
- Get a good overview of the problem; make notes during the troubleshooting process.
- Start by looking for simple causes such as incorrect baud rate, power not connected, bad connections etc. If the system involves custom cables, power supply or the like, first assemble and test the instrument using just the cables and battery that came with the system. This is the easiest way to get the system to work, and if you have trouble, you can always return to this setup to confirm that problems are not caused by a faulty instrument.
- Measure the power supply current, check that the instrument responds to a “Break”.
- Components rarely fail; usually bad solder joints or short circuits are the cause of problems.

If you still have problems after consulting this guide, please take a look at [Nortek Support Site](#), where previously answered questions might answer your question. You can also contact our subsidiaries, sales representatives or Nortek Support. To help us in giving good support, please:

- be specific about the error – a screen shot is often helpful
- include if possible
 - an error description
 - firmware and software version
 - serial number (head ID, hardware ID or order number)
 - a raw sample file showing the error
 - the collected data set showing the error
 - result of tests as loop-back, current drain and LED signaling

6.1 Communication Problems

The first thing to do when connecting an instrument to a computer is try sending a break. Send a break by clicking Communication > Terminal Emulator, and click the Send Break button. If the instrument is powered and properly connected and if the terminal is set to use the correct serial port, you will see the instrument's [wake-up message](#). If not, check the section about Break responses.

The **most common issues** we encounter are solved by the following:

1. Swap the cable and USB converter. If you do not have a spare, check it with a multimeter.
2. Swap the complete endbell assembly. If you do not have a spare, inspect the pins on the 8-pin female bulkhead connector, with a magnifying glass and flashlight, and see if there is any dirt or corrosion. If the pins are dirty or corroded, you could try cleaning them very carefully with a round miniature file and blast them with compressed air.
3. Try a different computer.
4. Open up the instrument (see [2.3 of Service Manual](#)). Visually inspect the electronics board(s) and wiring harness. Look for any signs of water ingress, corrosion or broken wires. Try using a magnifying glass, corrosion can be very difficult to spot, especially on the wiring harness connector pins.
5. Swap the wiring harness with a spare, if you have one.

If you see a response consisting of garbled text or strange characters, the instrument and the Terminal Emulator might be using different baud rates. The solution is to try other baud rates. Baud rates can be selected under Communication > Serial Port. To auto-detect the baud rate, use Online > Stop Data Collection (or the corresponding toolbar button). If you have reason to believe that your computer is having problems, do not hesitate to try a different computer!

If nothing happens when sending a break, initially check if

- You have forgotten to power the system.
- The DB-9 connector has fallen out of the computer
- You are using the wrong serial port.
- You have forgotten that new instruments ship with the battery disconnected.
- Computers do not always behave as they should and not all of them have serial ports available. If one computer is giving you a problem, try another one instead.

If none of these points above solves the problem, continue with the troubleshooting tests described next. There is also the [Midlife Connection Troubleshooting guide](#) on the Nortek Support Site.

6.1.1 Test with Battery and Power Supply

Cables are often exposed to heavy use and the power connector might break. To ensure that this is not the reason causing problems, be sure that you test the communication with both the power supply and the battery inside the housing connected. Also:

- Measure the power supply and make sure it is stable
- Do not exceed the maximum VDC listed in the technical specifications
- Remember that Nortek instruments ship without the batteries connected

6.1.2 Cable test

- Perform a continuity test on the cable by "beeping" each pin to pin. If you are experiencing intermittent connections try wiggling the cable around to see if there is a cable breakage.
- Make sure you are using correct cable compared to your harness (f.ex RS232 communication on both harness and cable)
- Check the cable for electrical short circuits or discontinuities using a multimeter (resistance tester).
- Keep the cable connected to the instrument, and disconnect the cable from the Interface box, PC or power source.
- Pin 1 & 2 should show similar magnitude of Ohm. The same goes for pin 3 & 4 and 5 & 6.

6.1.3 Serial-to-USB Converter

- The converter should blink when first connected.
- Converter matches the cable (f.ex RS232 converter with matching RS232 cable).
- On RS422 converters check that the pins on the USB end have not been pushed in.

6.1.4 Baud Rate

- Standard: 9600 baud rate
- If you receive garbled text or strange characters in the Terminal Emulator, check the baud rate
- Pressing Stop Data Collection will prompt the software to search through all baud rates
- To update the baud rate go to Communication > Serial Port and set it to the correct value (as above), then press Online > Stop Data Collection

6.1.5 Serial COM port

- Go to Communication > Serial port and select the correct port from the drop-down Serial port menu
- When connected the COM port will appear in the Device Manager (see screenshot)
- Will usually appear as USB Serial Port (COMx)

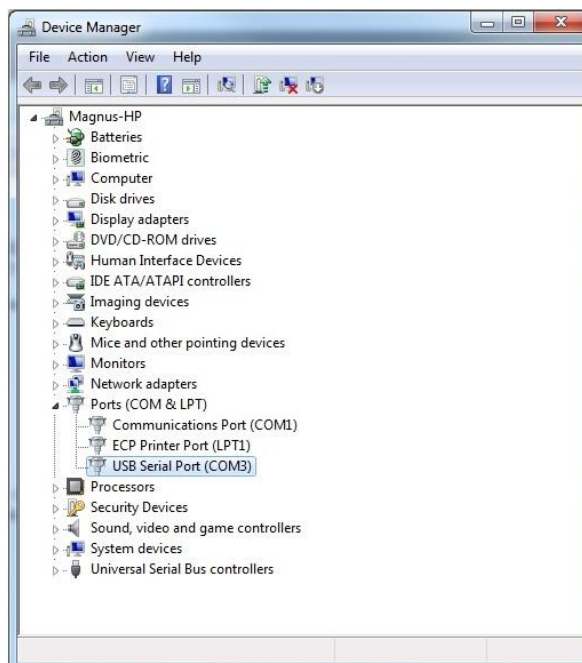

6.1.6 Break Response

Send a break by clicking Communication > Terminal Emulator, and click the Send Break button. If the instrument is powered and properly connected and if the terminal is set to use the correct serial port, you will see the instrument's wake-up message (AquaPro example below):

```
@@@@@@@
AQUAPRO
NORTEK 2012
Version 3.39
Command mode
¶¶
```

Other responses:

1. @@@@@@K1W%!Q@@@@@K1W%!Q

Suggestion: Check that you are using the correct cable (with correct communication - RS232 or RS422)

2.

Suggestion: Check that you are using the correct baud rate.

3. (no response)

Suggestion: Check that you are using the correct serial port. Go to the device manager; disconnect the USB to serial converter and then connect it again to detect the correct port.

4. MEASURING

Suggestion: The instrument is measuring. If you want to stop the instrument, send MC ("Message Confirmed"). If you want the measurements to continue, do not do anything.

6.1.7 Loop Back Test

The serial loopback test verifies that the serial port can receive the same characters as it sends. The aim of this test is to short-circuit the Tx and Rx lines, send a character using the Tx line and loop it back to the Rx line.

At the serial port

- Make a loop-back connector and plug it into your serial port as shown in the figure below.
- Now, run the test with the software's built-in Terminal Emulator, and if that does not work, try HyperTerminal instead (a terminal program that comes with Windows).
- Type characters - whatever you type should be echoed to the screen. Once you remove the connector, the characters should stop echoing back.

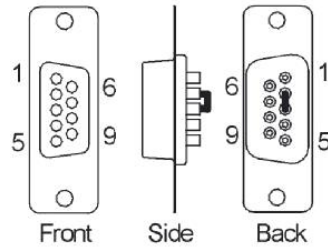

Figure: Serial loop back connector

At the serial cable

- Plug the cable into the computer
- Put a loopback connector on the end of the cable; that is, short-circuit pin 3 & 4 on the 8-pin underwater connector. This applies to RS-232 communication only.
- The same principle applies to RS422, except Rx+/Tx+ and Rx-/Tx- must be short-circuited - respectively pin 8/3 and 7/4. This will be the same on the DSUB as for RS232, since that is after the signal is converted.

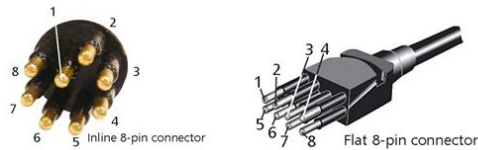

Figure: 8-pin connectors

6.1.8 Test with both RS422 and RS232 communication

Our instruments are able to communicate with both RS232 and RS422. When not able to communicate with the option installed, it could be a good idea to try the different alternative. To do this you will need both cable and harness wired for this communication.

6.1.9 Check Current Drain

If you have the possibility to power the instrument with a power supply that displays the current drain, this could give good diagnostic data. Send the commands listed in the table below in the Terminal Emulator. The instrument should not drain more than 0,5A continuously. Typical current drains are (15V):

Mode	Command	Current Drain
Command mode	<BREAK>	8-12 mA
Power down	PD	1-2mA
Measurement mode	ST	~3-150mA (cycling)

When performing a current drain test here, we usually leave the power on for about 12-15 hours (perhaps even longer) in advance to make sure the internal battery is fully charged. Note that the values above is for RS232. Using RS422 will result in different values. Note also that the Continental has much higher current drain.

6.1.10 Check Fuse

If the instrument does not drain any current, disassemble the instrument and find the 3A fuse that is protecting the power input. There should be close to 0Ω between the terminals on the fuse. In other words if your input power source is 15V there should be 15V on both terminals of the fuse.



Figure: Fuse on circuit board

6.1.11 Check LED Indications

The midlife hardware has a dual LED consisting of one green and one red LED. The firmware uses the LEDs to indicate the state it is in. The following combinations are used:

- A short red flash occurs when the board boots. This means that reception of a break will also cause a red flash as well as start of a new measurement based on an alarm from the real time clock and when power is applied to the board.
- Continuous green and red indicates that the board is in firmware upgrade mode.
- Continuous green only indicates command mode.
- In measurement mode, the green LED will flash when either of the beams pings. This will typically indicate which part of the measurement cycle the system is in as the ping rate is usually much higher in wave/diagnostics mode than during the regular profiling/point measurement.

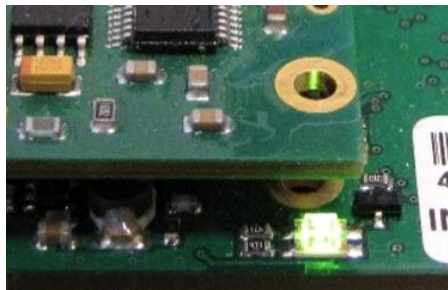

Figure: LED on circuit board

6.1.12 Check Interface Box

- Check the LED light display. The lights will turn red in case of error.
- The upper light (“Power on”) shows the status of the main power, and will lit green when the power is on.
- Rx and Tx indicators describe the status of the receive signal and the transmit signal, respectively. The Rx will blink when the instrument receive signals, the Tx will blink when it transmits.
- The Error power and Error cable indicators lit in case of power or cable failure.

6.1.13 Checksum Error

A checksum error means there was a problem with the serial communications. The checksum is at its simplest the sum of all of the bytes from the start of a data string to the end. This is generally encoded at the end of the data string and used to check for communication errors. A checksum error occurs when the computed checksum on the receiving end does not match the transmitted value.

Generally, this means there is some noise on the communications line and one of the bits was mis-transmitted or something similar, although in this case it could be due to the data buffer overflow and the data strings getting a little out of sync. For example, a data string could start and then the buffer overflow error occurs, so a portion of that data string is lost.

6.1.14 Flash Corrupt

The message "Error: Flash Corrupt (I)" may appear in the Terminal Emulator. It can also be identified by looking at the dual LED on the main PCB blinking red once per second.

The flash corrupt message indicates a problem with the part of the recorder flash where internal parameters are stored such as baud rate, instrument mode etc. The corrective action is to try to erase the recorder and see if the problem disappears. The cause of this error is typically extensive "recorder wear" which can cause flash failure. We have seen this in cases where instruments have been used with a high rate of measurement start/stop sequencing usually only done by system integrators. If you see this error and use a controller to operate the instrument autonomously you may have to change the way you operate the instrument. For example using the commands that measure and output single samples from command mode or controlling the data flow by controlling the power to the instrument.

Another solution to this is to replace the flash which is a relatively simple operation. Nortek Support will send a short document describing the procedure when it is necessary along with the ready programmed flash and a special tool.

6.2 Instrument Stopped During Data Collection

There are mainly two problems that may cause an instrument to stop during data collection; power is discharged or the recorder is full.

6.2.1 Power

The instrument specific software allows you to calculate the anticipated power consumption as a function of the sampling scheme and planned deployment duration. The predicted power consumption is given in percentage, where 100% signifies complete depletion of a chosen battery pack for the particular instrument. Make sure the power requirements calculated in the deployment planning dialog (see figure below) are met before deploying.

Note that this calculation is based on using new batteries only, and we recommend that you to always use fresh batteries when deploying an instrument. It is just not worth taking any risk with possible non-collection or loss of data or any instrument failure due to low battery level. Consider the cost of deployment and recovery of an instrument and place that against the cost of a fresh battery pack. As standard practice, we always install a fresh battery pack before every instrument deployment.

6.2.2 Full Recorder

Always start a new deployment with an empty memory. To erase the instrument's recorder:

- Make sure that you have transferred all the data you want to retain to your computer (if applicable) and that the data is in good shape.
- Click Deployment > Erase Recorder.

It is also a good routine to pay attention to the Memory required review in the right side of the deployment planning dialog (see screenshot below).

Figure: Deployment planning dialog, AquaPro software. Note the Battery utilization output

The file wrapping option can be used to prevent the recorder from becoming full. Ticking this option in the deployment configuration window will mean that once the recorder reaches capacity, the oldest data will be overwritten by new data until the deployment is stopped or the battery is depleted. Be aware that file wrapping is not available for 16 GB recorders.

6.3 Suspicious Data

If your data does not look right, the first step should be to check how the instrument was deployed. Inspect its Pitch, Roll and Heading readings, in addition to pressure. This will in an efficient way tell you how the instrument has behaved during deployment, and, most importantly, indicate whether the data are trustworthy or not.

6.3.1 Signal Strength

The instrument cannot measure velocity accurately if the water has too few scatterers. Your data will be questionable when signal levels are down around the noise level (around 20–30 counts), a rule of thumb is that the signal should be at least 3 dB higher than the noise floor. When using the instrument in high latitude areas the purity of the water can affect the signal strength and thus also profiling range. The low presence of scattering particles in the water cause extremely low reflected signal level.

If your data does not look right, particularly if you have unrealistic vertical velocities, consider the possibility that one or more of the beams were blocked. If the blockage is somewhere inside the measurement cell of one beam, you should see elevated signal strength for that beam. If the blockage is closer to the instrument, the signal strength may not look very different from the other beams, or it could be substantially reduced. Below are some examples of both good and bad amplitude profiles.

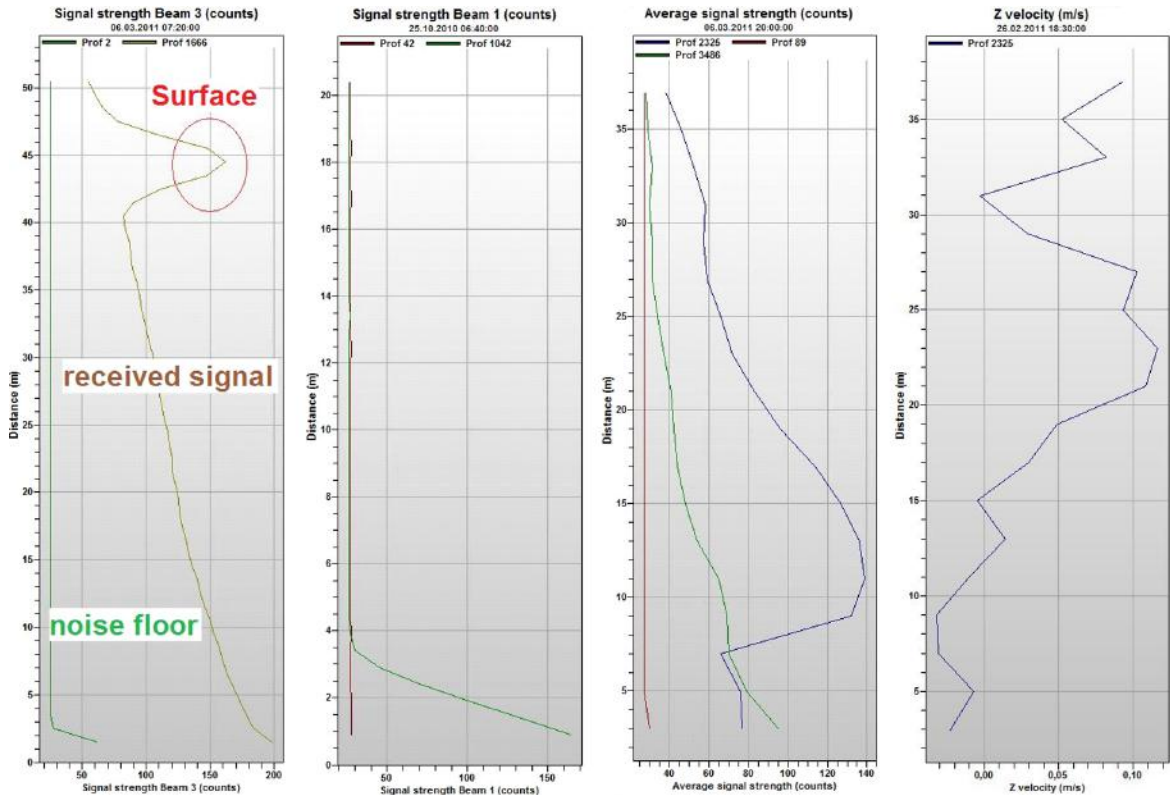

Figure: #1 from left: A good profile. The signal strength profile starts high and exponentially decreases with range. At some point it increase substantially because the transmit pulse has met a boundary (surface or bottom). Note also the Noise Floor profile. The signal should be at least 3 dB higher than the noise floor. **#2:** Short range. The signal no longer decreases and become constant. It has reached the noise level. No signal is returned to the instrument and the velocity measured is only noise. In this example, the instrument was covered with sand. **#3:** Blockage. Green profile is a good profile for comparison. Blue profile is increasing at about 10 meters due to blockage. **#4:** The result of the blockage in Figure #3 is corrupted velocity measurement. This profile shows unreasonable vertical velocity.

6.3.2 Boundaries

In open waters, boundaries are not a concern, but if you want to use the instrument near the bottom or surface, you should think about the boundaries as you design your experiment. If one of the beams cross a hard boundary, whether surface, bottom or wall, velocity data from that beam will be bad, as seen in the figure above. There are several different ways to improve the situation; one example is to change the orientation of the instrument.

Profilers looking up or down typically loose data near the surface or bottom. This loss is caused by contamination of the near-surface data by sidelobe echoes. The acoustic beams focus most of the

energy in the center of the beams, but a small amount leaks out in other directions. Transducer sidelobes are rays of acoustic energy that go in directions other than the main lobe. Because sound reflects stronger from the water surface than it does from the water, the small signals that travel straight to the surface can produce sufficient echo to contaminate the signal from the water. Note that because the instruments beams are narrow, sidelobes are not always a factor in your measurements. In general, sidelobes may be unimportant in water with strong backscatter, but they may contaminate your data when backscatter is weak. Read more about sidelobes in the [Principles of Operation](#).

The sidelobe interference will typically result in a bias towards zero for a bottom, unless the bottom is moving. For the surface the bias will depend on the sea state or surface wind conditions.

6.3.3 Grounding Problems

Tests in laboratory tanks can sometimes lead to grounding problems that show up as elevated noise levels, but only after the instrument is submerged in water. You will not automatically see the increased noise level in your data if your signal from the water is above the noise, but the increased noise level could look like signal. If grounding problems cause elevated noise levels, you may be able to reduce your problems by coiling your cable into a tight bundle and raising the cable above the floor (i.e. placing it on a chair). Also, feel free to call us for further guidance. Keep in mind that grounding problems occur around man-made structures, and are not normally a problem in the field.

6.3.4 AquaPro HR: Phase Wrapping

Please check out the [Principles of Operation](#) and “A Practical Primer for Pulse Coherent Instruments” (available on the web) for details regarding phase wrapping. The essential is that the Doppler phase shift is computed using the covariance method, and this restricts solving the phase difference within the range of $[-\pi, \pi]$ or as reported by the planning software. This introduces the problem of ambiguous determination of the phase shift; if the phase difference goes outside the range of $\pm\pi$, the measurement uniqueness is lost, something known as velocity ambiguity.

We see this phase wrapping in a velocity trace as an abrupt, unrealistic change in magnitude, usually with a change in sign. While it is possible for phase wrapping to occur without a sign change, this would be the result of an extremely large wrap where the phase shift exceeds 2π , in which case decorrelation would likely occur first.

It is generally best to avoid phase wrapping issues as the time spent correcting them is often significant. The best tip is to have some prior knowledge about the area of interest, so that you can set the Velocity Range properly.

6.3.5 Error and Status Codes

The Aquadopp, Aquadopp Profiler, AWAC and Continental all output two multiple bit binary coded words describing the instrument state. The following explains the meaning of each bit in the Error and Status words (more information in the [Integrators Guide](#)). The bits within the words count from right to left starting with zero.

Error word:

The bit is set ("1") if there is an error condition and cleared ("0") if ok.

Bit 7 - Coordinate transformation: If the compass fails and the system is set to ENU the system will output XYZ and this bit will be set.

Bit 6 - Sensor: Aquadopp: The CT sensor (serial only - e.g. Seabird) is not responding.

Bit 5 - Beam number: A problem has occurred with the beam order.

Bit 4 - Flash: An error has occurred in the primary system flash memory and the system may not be able to reboot.

Bit 3 - Tag bit: There has been an error in the processing, an internal buffer is overflowing.

Bit 2 - Sensor data: One of the sensors is not operating correctly.

Bit 1 - Measurement data: An error has occurred with some element of the processing, the data is probably corrupted.

Bit 0 - Compass: The compass does not respond. If the system is in ENU mode it will default to XYZ, and a value of 90 degrees will be displayed.

Status word:

Bits 7 and 6 - Power level: These bits reflect the power level setting, i.e. how much acoustic energy the instrument transmits into the water. This is set by the user in the deployment planning dialog when configuring the instrument.

Bit 7	Bit 6	Power level
0	0	High
0	1	High -
1	0	Low +
1	1	Low

Bits 5 and 4 - Wakeup state: These bits indicate the wakeup state of the instrument. There are four different ways that can cause a wakeup of the instrument and hence there are two bits in the status field that identify the wakeup source.

Bit 5	Bit 4	Wakeup state
0	0	Bad power
0	1	Power supplied
1	0	Break
1	1	Real Time Clock (RTC)

Bad power status is used when the input voltage to the instrument during normal operation is so low that the instrument may no longer operate correctly. The hardware is then held in a reset state until the voltage reaches an acceptable level. It is typically caused by a broken cable or a faulty power supply.

Power supplied is the status code when power is applied to an instrument. To get this status code the power must typically be removed for a few seconds. Removing power for just one second will typically be indicated as bad power.

Break status indicates an instrument reset because a break was received on the communications port. The break is used when the software communicates with the instrument. This will typically be status code in the first data record in an online measurement.

Real Time Clock status shows that the internal clock in the instrument caused the wakeup. To reduce the power consumption the instruments enters sleep mode between measurements for most setups. The internal RTC will ensure that the instrument wakes up at the appropriate time and this is indicated in the status byte.

Bit 3 - Roll: This bit indicates if the instrument roll angle exceeds the tilt sensor operational range limits.

Bit 3	Roll
0	Ok, valid data
1	Out of range, invalid data

Bit 2 - Pitch: This bit indicates if the instrument pitch angle exceeds the tilt sensor operational range limits.

Bit 2 Pitch

- 0 Ok, valid data
- 1 Out of range, invalid data

Bit 1 - Scaling: Not relevant (Vector only)

Bit 0 - Orientation: This bit indicates the orientation of the instrument.

Bit 0 Orientation

- 0 Up
- 1 Down

6.3.6 Vessel Mounted Current Profiler Data

This section concerns the vessel-mounted AWAC only. For information on the vessel-mounted Signature, please see the [SignatureVM Operations manual](#).

6.3.6.1 Unrealistic Values

The problem may result from three different reasons:

- Missing or bad quality data from the GPS. You should check that the interface is present and installed with correct port number and baud rate.
- Low amplitude. Observe the Signal Strength under the Vessel Profile Graph display. A stable low counts value (straight vertical line) at all depths is a strong indicator that something is wrong. The cause of low amplitudes may be barnacles present on the transducers, thus they need to be cleaned. In case, it is highly recommended to avoid using strong detergents. You may also want to check that the depth cell chosen (Calculations menu) for closer review has amplitude high enough (>5 counts above noise floor) to give credible data.
- Bad or no calibration. The directional information appears to be random or unlikely, e.g. the sticks in the stick plot tend to turn along with the vessel heading, or there is asymmetry in the velocity sticks. The solution is recalibration. Follow the calibration procedure described in the [VMCP Quick Guide](#).
- Unstable current readings; each second, instrument produces very different current readings. Set the averaging interval to a minimum of 30 seconds.
- Cavitation effect could appear due to the shape of the boat or of the blister. In that case the signal strength will decrease very rapidly to the background noise as transducer beams will be blocked by the bubble layer.

6.3.6.2 No or Intermittent Data

The problem may result from three different reasons:

- Failure of the Interface box. You should perform an inspection of the Interface Box. If one of the two lower LED lights lit red, there is most likely a problem with the cable.
- Failure of the cable or connection. Please perform a Cable test; check the Ohm value of the 6 pins:

Pin	Value of Ohm
1 & 2	1 MOhm
3 & 4	130 Ohm

5 & 6

1 MOhm

- Failure of the instrument. If the cable, interface unit and PC appear to be ok, and the system is still failing, please contact Nortek in order to discuss further actions. In case, please send the following raw data files, preferably also with a completed Trouble Report ([Appendix B](#)) to Nortek Support for further guidance:
 - SurveyVM v1: *.adp, *.gps, *.gyr, *.rcf,
 - SurveyVM v2: *.wpr, *.ves, *.svm

6.3.6.3 Calibration Sanity Check

The VMCP scaling corrects for sound speed errors and hull-induced flow effects. because both of these are normally small, the correction should be between 0.9 and 1.1 – ideally between 0.98 and 1.02. You can detect small errors in your calibration parameters by inspecting the stick plots:

- If you see a consistent current to the right or left of the ship track, suspect a small error in the heading offset. If you see a current that tends to follow the direction (or opposite the direction) of the ship, suspect an error in the VMCP scaling.
- If you have a large error in either factor, you will see a large error in the readings that should be quickly apparent. For example, if your display shows strong currents across the ship track, but the ship's compass lines up with the course track; suspect a large error in your calibration, or that profile averaging includes the bottom.

In installations in which the navigation system provides compass readings already corrected to true north, your heading offset angle should reflect primarily the transducer mounting angle offset. You can quickly check this offset in the current display. when you click the raw button, the next current display will show you the uncorrected current. This current should point opposite the direction of the ship (see figure below).

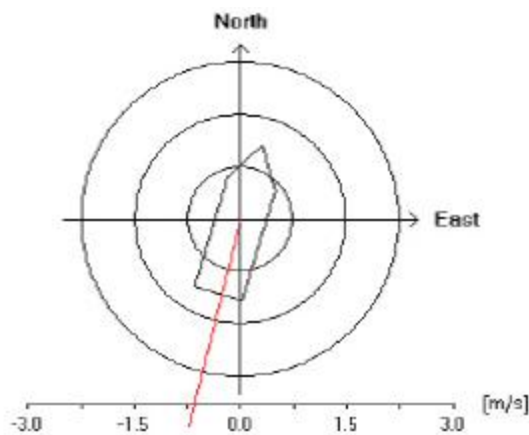

Figure: example of a "raw" current display, i.e. when the heading offset includes correction only for installation offsets, but not compass offsets.

6.4 Returning Instruments for Repair

Before any product is returned for repair you must have obtained a Return Merchandise Authorization (RMA) in writing from your local representative or Nortek AS, which identifies the system for customs and for internal production control purposes. All instrument repairs will have to be approved and coordinated by Nortek Support or your local Nortek representative.

Proforma Invoice

You must complete a proforma invoice. Include all the information requested and ensure that it is correct. Use the copy in [Appendix C](#), or in [this FAQ](#).

Include 3 copies of all shipping and export documents with the proforma invoice attached to the freight box. Make sure you include a copy of all shipping and export documents with the proforma invoice inside the freight box.

For customs purposes, we recommend that you clearly label the commercial invoice with expressions such as "Return to the original manufacturer Nortek AS for warranty repair. Will be returned to sender". Using the term "warranty" simplifies customs handling and can be used even if the system is returned after the warranty period has expired.

Insurance

Note that freight insurance on repairs is not covered by Nortek. You must make sure your goods are properly insured before shipping to Nortek AS. We will not be held responsible if the instrument is damaged or lost while being shipped to Nortek for repair. Similarly, Nortek will not be held responsible for consequential damages as a result of instruments becoming damaged or lost while being shipped to Nortek for repair.

All RMA products must be carefully and securely packed to protect against shipping damage. Return products in their original shipping containers if at all possible. Use antistatic bags to protect against electrostatic discharge (ESD) if you are returning a circuit board.

Nortek will always insure instruments returned to a customer after service or repair. You will be invoiced the cost of this insurance along with other charges relating to the repair and shipping costs.

If the instrument is repaired under warranty Nortek will cover all return shipping and insurance costs.

Customs regulations

The regulations and requirements covering the export and re-import of items sent for repair will vary from country to country, and in the past some of our customers have experienced problems because they failed to provide the correct documentation. If these matters are not handled correctly, you may be charged for import duties and taxes a second time when your instrument is returned to you.

We at Nortek must meet our own country's regulations when taking instruments for repair and when returning them. This may not be enough for your country.

We strongly suggest that, as part of your own procedures for handling any returns, you check with your customs authorities as to what information, documents etc. they need from you and from us. You should then inform us of what you need by e-mail, fax or mail. We will do all we can to help you.

Batteries

Please do not include any batteries when returning an instrument unless specifically requested. If they are included you will not get them back because of rules regarding shipping dangerous goods. No type of battery can be shipped within a pressure housing (i.e. the instrument housing). Lithium and lithium-ion batteries are also dangerous goods and shipping them as ordinary goods is strictly prohibited.

HS code for customs clearance:

9015.80.80 Oceanographic instruments

Returning DVLs

The Nortek DVL follows the standard codes, and the HS code is 9015.80.80 Oceanographic instruments. The export restrictions list code for the Dual Use functionality is 6A001.b.23

Repairs

We will confirm the receipt of the equipment and inform you of any chargeable cost associated with repairs. Billing will be done at standard rates for repair and retest if the failure is due to warranty violations or misuse. Make sure to clearly state where you want us to send the repaired system and what shipping method you prefer.

Appendices

SECTION



7

7 Appendices

7.1 Appendix A - Final Test Checklist

Final test checklist

Order number 	Head ID Hardware ID Frequency 																														
System type <input type="checkbox"/> Aquadopp <input type="checkbox"/> Aquadopp profiler <input type="checkbox"/> Vector <input type="checkbox"/> AWAC <input type="checkbox"/> Continental <input type="checkbox"/>	Firmware version Comments 																														
<div style="float: right; border: 1px solid black; padding: 5px; width: fit-content;">Lable checked <input type="checkbox"/> OK</div> <div style="float: right; border: 1px solid black; padding: 5px; width: fit-content;">Dock test <input type="checkbox"/> OK</div>																															
Tilt check <input type="checkbox"/> Pitch up <input type="checkbox"/> Roll up <input type="checkbox"/> Status bit <input type="checkbox"/> Pitch down <input type="checkbox"/> Roll down <p style="font-size: small;">pitch & roll within $\pm 0.2^\circ$</p>	Heading <input type="checkbox"/> Up <input type="checkbox"/> Down <p style="font-size: small;">tolerance: $\pm 0.2^\circ$</p>																														
<div style="display: flex; align-items: center;"> <div style="flex: 1;"> <p>Pressure</p> <p style="font-size: small;">tolerance: $\pm 0.5\%$ of _____m</p> <input type="checkbox"/> OK </div> <div style="flex: 1; padding-left: 20px;"> <p>Temperature</p> <input type="checkbox"/> OK <p style="font-size: small;">tolerance: $\pm 0.1^\circ$</p> </div> </div>																															
<table border="1" style="width: 100%; border-collapse: collapse; font-size: small;"> <thead> <tr> <th style="width: 20%;">Beam check</th> <th style="width: 10%;">Correct order</th> <th style="width: 15%;">Noise floor</th> <th style="width: 15%;">Amplitude in tank</th> <th style="width: 15%;">Range</th> <th style="width: 25%;">Velocity direction</th> </tr> </thead> <tbody> <tr> <td>Beam 1</td> <td><input type="checkbox"/> OK</td> <td><input type="text"/></td> <td>> <input type="text"/></td> <td><input type="checkbox"/> OK</td> <td><input type="checkbox"/> X <input type="checkbox"/> E</td> </tr> <tr> <td>Beam 2</td> <td><input type="checkbox"/> OK</td> <td><input type="text"/></td> <td>> <input type="text"/></td> <td><input type="checkbox"/> OK</td> <td><input type="checkbox"/> Y <input type="checkbox"/> N</td> </tr> <tr> <td>Beam 3</td> <td><input type="checkbox"/> OK</td> <td><input type="text"/></td> <td>> <input type="text"/></td> <td><input type="checkbox"/> OK</td> <td><input type="checkbox"/> Z <input type="checkbox"/> U</td> </tr> <tr> <td>Beam 4</td> <td><input type="checkbox"/> OK</td> <td><input type="text"/></td> <td>> <input type="text"/></td> <td><input type="checkbox"/> OK</td> <td></td> </tr> </tbody> </table>		Beam check	Correct order	Noise floor	Amplitude in tank	Range	Velocity direction	Beam 1	<input type="checkbox"/> OK	<input type="text"/>	> <input type="text"/>	<input type="checkbox"/> OK	<input type="checkbox"/> X <input type="checkbox"/> E	Beam 2	<input type="checkbox"/> OK	<input type="text"/>	> <input type="text"/>	<input type="checkbox"/> OK	<input type="checkbox"/> Y <input type="checkbox"/> N	Beam 3	<input type="checkbox"/> OK	<input type="text"/>	> <input type="text"/>	<input type="checkbox"/> OK	<input type="checkbox"/> Z <input type="checkbox"/> U	Beam 4	<input type="checkbox"/> OK	<input type="text"/>	> <input type="text"/>	<input type="checkbox"/> OK	
Beam check	Correct order	Noise floor	Amplitude in tank	Range	Velocity direction																										
Beam 1	<input type="checkbox"/> OK	<input type="text"/>	> <input type="text"/>	<input type="checkbox"/> OK	<input type="checkbox"/> X <input type="checkbox"/> E																										
Beam 2	<input type="checkbox"/> OK	<input type="text"/>	> <input type="text"/>	<input type="checkbox"/> OK	<input type="checkbox"/> Y <input type="checkbox"/> N																										
Beam 3	<input type="checkbox"/> OK	<input type="text"/>	> <input type="text"/>	<input type="checkbox"/> OK	<input type="checkbox"/> Z <input type="checkbox"/> U																										
Beam 4	<input type="checkbox"/> OK	<input type="text"/>	> <input type="text"/>	<input type="checkbox"/> OK																											
Head file <input type="checkbox"/> Headfile checked <input type="checkbox"/> Saved as read only	Harness test <input type="checkbox"/> OK Type: <input type="text"/>																														
Recorder erased <input type="checkbox"/> OK Rec. size: <input type="text"/> MB																															
External sensors																															
Power down <input type="checkbox"/> OK <input type="checkbox"/> Battery disconnected upon shipping	<table style="width: 100%; border-collapse: collapse;"> <tr> <td style="border: 1px solid black; width: 30px; text-align: center; font-size: x-small;">day</td> <td style="border: 1px solid black; width: 30px; text-align: center; font-size: x-small;">month</td> <td style="border: 1px solid black; width: 30px; text-align: center; font-size: x-small;">year</td> <td style="border-bottom: 1px solid black; width: 150px;"></td> </tr> <tr> <td colspan="3" style="text-align: center; font-size: x-small;">Date</td> <td style="text-align: center; font-size: x-small;">Signature</td> </tr> </table>	day	month	year		Date			Signature																						
day	month	year																													
Date			Signature																												

NOM 03-110-01

7.2 Appendix B - Trouble Report - VMCP

Trouble Report

Company:	
Contact Person:	

Instrument ID:		Color of Cable:	
Software Version:		Interface Box:	<input type="checkbox"/> LED <input type="checkbox"/> No LED

Has the instrument ever worked?
<input type="checkbox"/> No <input type="checkbox"/> Yes
<i>Details about what was done immediately before the problem (e.g. New PC, new serial port, cable junction, etc...) or any error messages at the time can be helpful when diagnosing and fixing the problem:</i>

Describe the error by using the checklist below, and perform the suggested solution:						
<i>Note that the table below is divided into two sections. Follow the section that belongs to the type of error that applies to your problem.</i>						
Type of error	<input type="checkbox"/> Unrealistic values			<input type="checkbox"/> No or intermittent data		
	Possible Cause					
Check for confirmation	<input type="checkbox"/> GPS problem (missing or bad quality data)	<input type="checkbox"/> Low Amplitude	<input type="checkbox"/> Bad/No calibration	<input type="checkbox"/> Failure of the Interface box	<input type="checkbox"/> Failure of the cable or connection	<input type="checkbox"/> Failure of the instrument
	<input type="checkbox"/> Check that the interface is present and installed with correct port number and baud rate. <input type="checkbox"/> Check that the incoming format is correct, e.g. by using a terminal or serial port emulator program.	<input type="checkbox"/> Observe the Signal strength under Vessel Profile Graphs display. A stable low counts value (straight vertical line) at all depths is a strong indicator that something is wrong. You may want to check that the depth cell chosen (Calculations menu) for closer review has amplitude high enough (>5 counts above noise floor) to give credible data.	<input type="checkbox"/> The directional information appears to be random or unlikely, e.g. the sticks in the stick plot tend to turn along with the vessel heading, or there is asymmetry in the velocity sticks.	<input type="checkbox"/> Perform an Inspection of the Interface Box (cf. margin on the previous page). If one of the two lower LED lights lit red, there is most likely a problem with the cable.	<input type="checkbox"/> Perform a Cable test ; check the Ohm value of the 6 pins (cf. table and description in the margin on the previous page). <input type="checkbox"/> Check that no serial mouse or other device driver is installed on any of the serial ports used by the VMCP or external sensors.	<input type="checkbox"/> If the cable, interface unit and PC appear to be ok, and the system is still failing, please contact Nortek in order to discuss further actions.
Solution		Barnacles on transducers; needs to be cleaned. It is highly recommended to avoid using strong detergents.	Recalibration, follow the Calibration procedure.	Please send the raw data files (SurveyVM v1: *.adp, *.gps, *.gvr, *.rcf, SurveyVM v2: *.wpr, *.ves, *.svm) together with this report to support@nortek.no .		

7.3 Appendix C - Example of Proforma Invoice



NOT A SALE

Temporary export to norway for repair

Sender (Exporter)	Receiver
Name:	Name: Nortek AS
Address:	Address: Vangkroken 2
City:	City: N-1351 Rud
Country:	Country: Norway
Tel:	Tel: +47 67 17 45 00
Fax:	Fax: +47 67 13 67 70
E-mail:	E-mail: inquiry@nortek.no
Ref:	Customs Account No.: 322 68 794 VAT/Company No.: 996 707 415 MVA

About the goods	
Date:	No. of Units:
Delivery Terms:	Weight:
Description of Goods:	Origin: NO
Reason for Export:	Total Value:
Return for repair	
Temporary	Nortek RMA No.:

Place:
Date:
Exporter's Name: