



NORTEK MANUALS

Signature Operations

250 | 500 | 1000kHz



Table of Contents

Ch. 1	Introduction	5
Ch. 2	System Overview 250/500/1000	7
Ch. 3	Getting Started	9
3.1	Checking the Inventory	9
3.2	Installing Software	9
3.3	Connecting the Instrument to PC via Ethernet	9
3.4	Initial Ethernet Connection	10
3.5	Serial communications	12
Ch. 4	Preparation	12
4.1	Functionality Test	12
4.2	Changing Batteries	16
4.3	Guide rail harness removal	18
4.4	Compass Calibration	19
4.5	Before Deployment	20
Ch. 5	Software	22
5.1	Discovery Tool	22
5.2	Deployment Wizard	23
5.3	Stand-Alone Deployment	34
5.4	Online Data Collection	36
5.5	Recorder Data Retrieval	37
5.6	Data Conversion	39
5.7	Post-Processing	41
5.8	Menus	41
	File	41
	Communication	41
	Planning	41
	Deployment	42
	Online	42
	Instrument	42

Help	43
Ch. 6 Mechanical Aspects and Maintenance	44
6.1 Instrument Care	44
6.2 Connector Care	45
6.3 Cable Care	45
6.4 Replace Desiccant Bag	45
6.5 O-ring Care	45
6.6 Securing Screws	46
6.7 Biofouling	47
Ch. 7 Troubleshooting	48
7.1 Communication	48
7.2 Network	50
7.3 Software Problem	50
Ch. 8 Appendices	52
8.1 Glossary	52
8.2 Communication and Ethernet	55
8.3 Terminal Emulator	57
8.4 Web interface	58
8.5 Universal Plug and Play	59
8.6 Synchronization	60
8.7 Connector Pin Configurations	61
8.8 Proforma Invoice	64

1 Introduction

This manual is designed to help users of Signature Series product line, also known as broadband instruments, to get familiar with the system and how to use it. The manual includes chapters covering how to get the instrument up and running as quickly as possible, functional testing, software information, and tips for maintenance and troubleshooting. Take a look at [Principles of Operation - Signature](#) for more in depth understanding on how the instrument works. For information about how to communicate, control and develop for your instrument, consult our [Integrators Guide - Signature](#).

Nortek online

At our website, www.nortekgroup.com, you will find technical support, user manuals, and the latest software and firmware. General information, technical notes, and user experience can also be found here.

Nortek FAQ

Our old forum where users from all over the world met to discuss and shared their experience with Nortek instruments has been converted to an FAQ section. If you have comments, questions, application tips, suggestions for improvements, or simply want to learn from others or share your own experience, we encourage you to [comment on the relevant FAQ](#) or [start a topic in our new forum](#).

Your feedback is appreciated

If you find errors, omissions or sections poorly explained, please do not hesitate to contact us. We appreciate your comments and your fellow users will as well.

Contact Information

We recommend first contacting your local sales representative before the Nortek main office. If you need more information, support or other assistance, you are always welcome to contact us or any of our subsidiaries by email, phone or fax.

Email: inquiry@nortekgroup.com for general inquiries or support@nortekgroup.com for technical support

Phone: +47 67 17 45 00



Fax: +47 67 13 67 70

You can also write us at:

Nortek AS
Vangkroken 2
1351 RUD
Norway

Version/revision	Date	Comments
2014.1	28.10.2014	Release
2014.2	17.11.2014	
2014.3	02.12.2014	
2015.1	09.06.2015	Software updates
2015.2	24.11.2015	Instrument updates
2016.1	29.02.2016	Software updates
2016.2	15.09.2016	Software updates
2017.1	10.02.2017	

2017.2	08.12.2017	
2018.1	26.06.2018	
2018.2	21.09.2018	
2021.1	04.06.2021	General updates, new software examples
2022.1	09.02.2022	General updates, formatting
2022.2	29.09.2022	Minor updates

	<p>The system is designed and produced to comply with the council directive of 2014/108/EC relating to electromagnetic compatibility. The instrument has passed the following tests according to EN61000-6-2:2005 and EN61000-6-3:2007/A1:2011/AC:2012 (practically similar to US FCC 15 part A in US): Conducted and radiated emission, voltage flicker, harmonic current, conducted radio frequency immunity, radiated electromagnetic field immunity, fast low energy transients/bursts, slow high energy transients/surges, voltage dips and interruptions, electrostatic discharge and power-frequency magnetic field. The design is also according to RoHS II directive 2011/65/EU.</p>
	<p>The mark on the left is in compliance with the Waste Electronic Equipment Directive 2012/19/EU (WEEE). This symbol indicates the requirement NOT to dispose the equipment as unsorted municipal waste, but use the return to collection systems according to local law or return to the Nortek facilities (address above).</p>
	<p>Relevant plastic parts on the product is marked for end of life recycling (Directive 2008/98/EC on waste)</p>

2 System Overview 250/500/1000

Signature1000, Signature500 and Signature250, three advanced five-beam current profiling systems, are made with the most demanding scientific user in mind. Built on the entirely new AD2CP platform, the Signature1000, Signature500 and Signature250 are designed for unprecedented performance in high energy turbulent environments, while also giving users the freedom to employ several measurement schemes at one time.

The figures below show the Signature1000 system but can be easily translated to the Signature500 and Signature250. The Signature1000 and Signature500 sensor heads have five acoustic transducers, four slanted at 25 degrees from vertical, and a fifth vertical beam. The Signature250 uses beams angled at 20 degrees and an optional fifth vertical beam. Note that the optional vertical beam on the Signature250 operates at 500 kHz. On the Signature500 and Signature1000 all beams operate at the same frequency. For dimensions, please refer to the specific instrument data sheet, available for download from our [website](#).

The pressure sensor, temperature sensor and LED light are all visible from the outside. Note also the beam configuration, with Beam 1 pointing in the positive X-direction (see the engraved axis definition on the head).

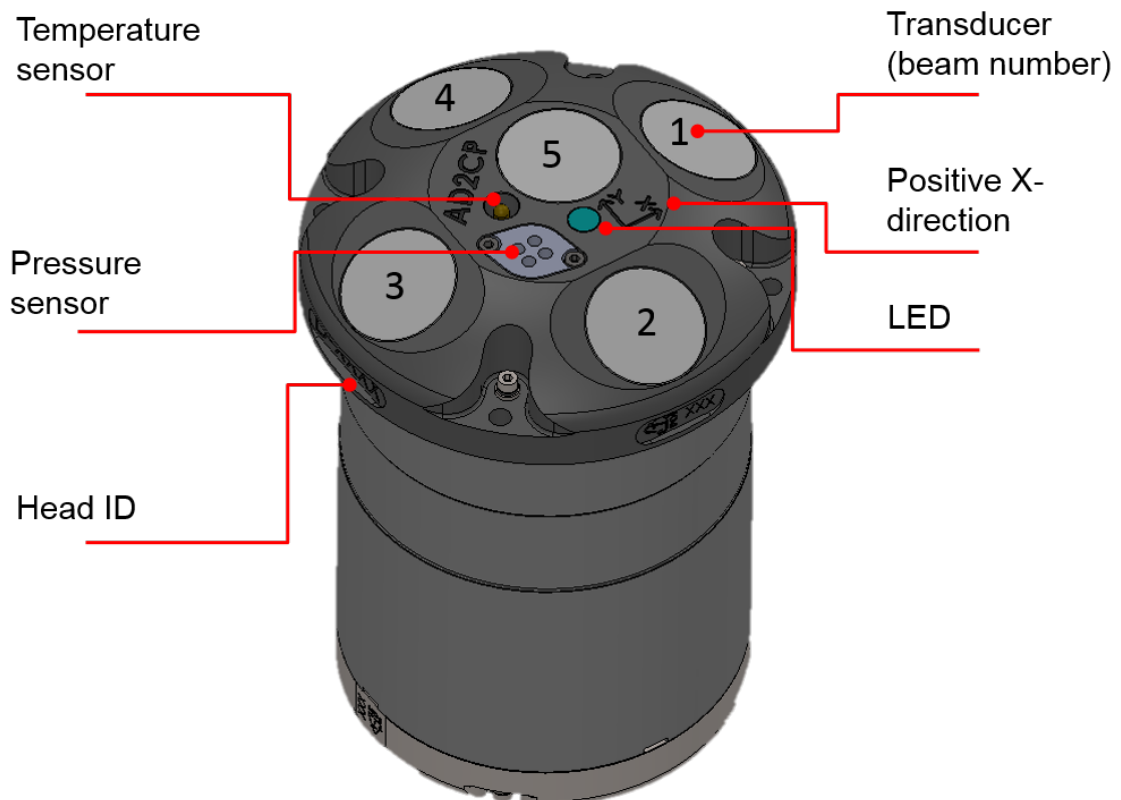

Figure 1. Signature1000 beam and sensor overview

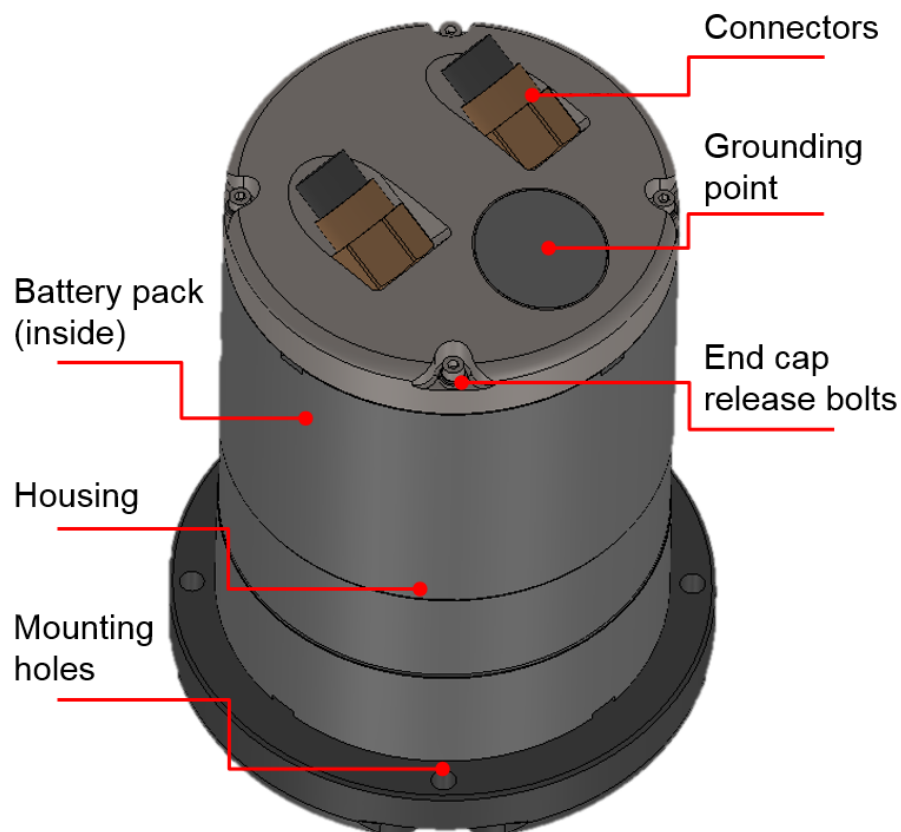

Figure 2. Signature1000 housing, end cap and connectors overview

Connector

The standard connectors are 2-pin + 6-pin brass Subconn by MacArtney. Optional 8-pin + 6-pin if the instrument is ordered with serial communication. There is the option to install the more robust Souriau connector for long term on-line use.

Power requirements:

Internal battery:

- Signature1000: 90 Wh, 3*10AA cells and 15VDC.
- Signature500: 180 Wh, 12 C cells and 18VDC.
- Signature250: 540Wh 18 V alkaline, or 1800Wh 19V Li.

External battery: Single or double alkaline 540Wh, or single or double lithium 1800Wh.

DC input: 12-48 (Sig500/1000), 15-48V (Sig250).

Note: Signature instruments cannot use Power over Ethernet (PoE) technology. Using PoE with your Signature instrument will damage the electronics board and require repair.

3 Getting Started

This chapter deals with installation of the accompanying software, connecting to the instrument and other information that is important for first time use of the instrument.

3.1 Checking the Inventory

Check the contents of the received package against the packing list included in the shipment. Do not hesitate to [contact us](#) if you find any part of the delivery missing.

3.2 Installing Software

The Nortek Deployment software is an important part of the Signature series and has been designed to aid you in the planning, execution and recovery of your instrument deployment. A thorough description of the software and its features can be found in the Operations manual. We recommend that you update when prompted by the software to ensure that you have all the new functionality accessible. To install the software:

- **Microsoft Store version:** Follow the link on our [software page](#); this will open MS Store from where you can install SignatureDeployment.
- **Installer version:** Find this version on the memory stick that came with the instrument, or download it from our [software page](#). This version includes dependencies that may need to be installed prior to installing the .msix file. If you have difficulty installing this version even with the dependencies, [contact Nortek Support](#).

System requirements:

Component	Requirement
Processor	1 GHz or faster processor
Memory	1 GB RAM
Hard disk	100 MB (programs)
Operating system	The software will run on Windows Vista or newer with .NET framework 4.5. If you use Mac OS platform: you have to rely on Windows-on-Mac virtualization programs such as Parallels Desktop
Display	1024x576 or higher resolution monitor

Licenses:

The Deployment software itself does not require a license to run. However, certain functions of the Signature instrument are protected under different licenses, so register your licenses (refer to the software help file for how to do this) in order to get the instrument to operate in a certain mode. Register purchased licenses while connected to your instrument under **Instrument > Licenses**. Licenses that are ordered with the instrument are already registered. You will not need a license when updating the firmware version.

3.3 Connecting the Instrument to PC via Ethernet

The Ethernet communication has been implemented by using a dedicated network processor, and needs to be powered by connecting a power supply to the external power breakout on the cable. Note that powering through the Ethernet cable will also power the rest of the electronics.

DO NOT APPLY POWER TO THE ETHERNET CABLE BEFORE YOU HAVE CONNECTED THE CABLE TO THE INSTRUMENT

If you power the Ethernet cable before you connect it to the instrument, there is a risk that you will connect the cable incorrectly and apply power to the wrong lines. This will cause components on the board to burn out. If this occurs, you will see a loss of communication and you will need to return the instrument to Nortek for repair.

1. Connect the supplied test cable to the communication output on your instrument, then apply power to the breakout cable. The blue LED should be turned on shortly.
2. Use a direct connection or an Ethernet switch to connect the Ethernet connector to your computer.
3. If you use a computer Ethernet port that has status lights, verify that the link is active by looking for a solid green light on the port. If an Ethernet switch is used, the Ethernet port should also show an active Ethernet link. If the status light is not lit refer to our [Troubleshooting Guide](#).

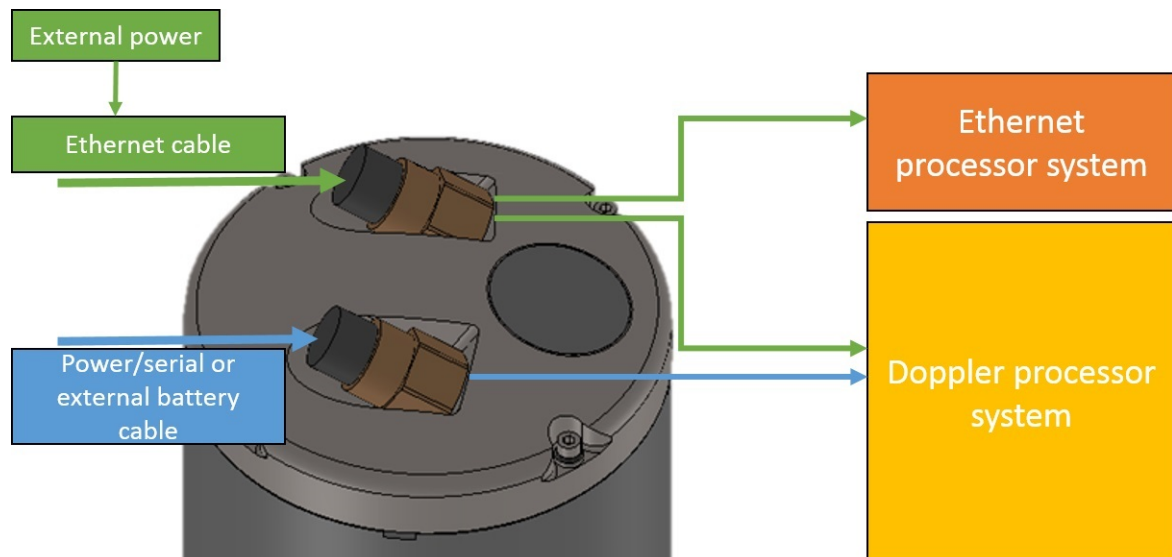

Figure 3. Power distribution. When the Ethernet cable is connected to the instrument, it will need to be powered from the power breakout cable. This will power both processor systems. If power is supplied through the Serial or external battery connector, the Ethernet processor is unavailable.

3.4 Initial Ethernet Connection

The first time using the instrument, the network address needs to be properly configured for the network. For new users who are unaware of how the network is set up, the instrument should be plugged either directly into a computer (Ethernet cable) or via an Ethernet switch connected to the computer. For more information consult the [Appendix](#).

Remember that external power must be supplied to connect using the Ethernet interface. Ensure that the correct cable is used to connect the instrument to the Ethernet port. Refer to the [previous section](#) or the [Troubleshooting Guide](#) if the LED on the instrument, the PC port or the switch are not lit in the correct manner.

1. Check the internet access status at the notification area in the taskbar of your PC. The screenshot below shows that a local connection has been established (the IP address has been set).

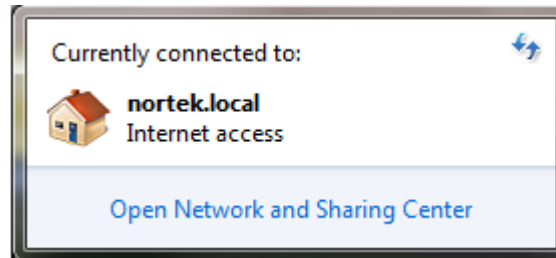

Figure 4. Local connection dialog box.

2. Open the Nortek Deployment software and click **Connect** to launch the Discovery feature (figure 5). This will produce a window with a list of instruments available on the network. It may take a few minutes before the Discovery tool lists a newly connected instrument. This is due to the IP address assignment process (more details are available in [Appendix](#)). If the instrument is not shown in the list, wait approximately 90 seconds and click **Discover** again. The computer is capable of communicating with the instruments shown with a white background in the list. If an instrument in the list has a red background, it is not possible to connect to it (see section [Software Problem](#)).
3. Select the instrument by finding the Serial number that matches your instrument and click **Connect**. With multiple instruments, assigning a suitable nickname for identification purposes should be useful. This can be found under **Instrument > Nickname** once you are connected.

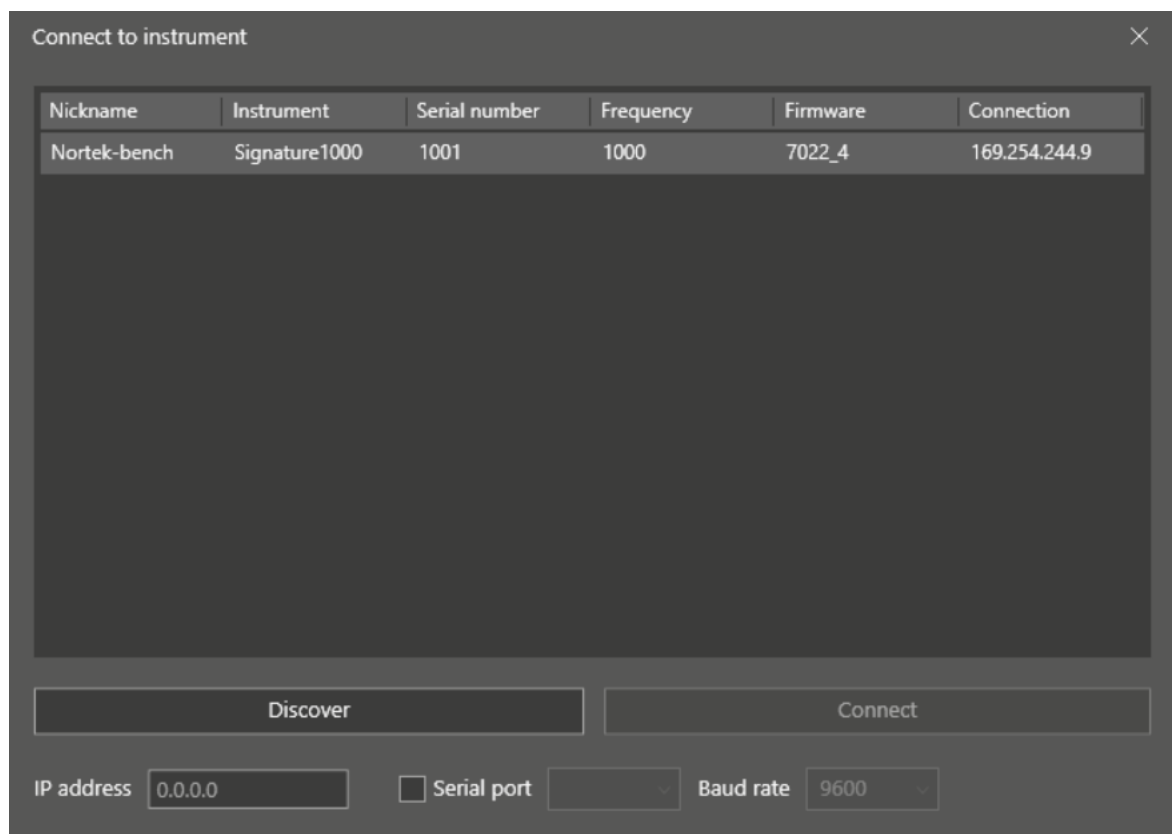

Figure 5. Discovery dialog

3.5 Serial communications

The Signatures can be purchased with both Ethernet and Serial communications. When connecting with serial, the only way to communicate with the Signature is through a terminal. The terminal in the SignatureDeployment software can be used, but no other part of the GUI will be available when connected over serial. Therefore any streamed data will only be available at binary or ASCII text.

For information on how to control the Signature instruments over a serial connection, please read the [Signature Integrators Guide](#).

4 Preparation

From this point on it is assumed that a stable, reliable connection with the instrument has been established. This is necessary to continue onwards for the next few sections of the manual. If the instrument is unable to connect with your PC please revisit the [Getting Started](#) chapter or consult the [Troubleshooting](#) chapter.

ALWAYS ENSURE YOUR SIGNATURE HAS THE LATEST FIRMWARE

Nortek releases firmware updates multiple times per year. We are constantly improving Signature functionality and components, so it is extremely important that the firmware on your instrument is kept up-to-date. Failing to keep the firmware updated may mean that your instrument will not work as intended.

Updating the firmware will not affect your installed licenses.

When you connect to a Signature, the SignatureDeployment software will prompt you to update the firmware if a new version is available (when connected to the internet). You can also check the [Software page](#) for updates. See [this chapter](#) for instructions.

4.1 Functionality Test

Before any sort of deployment test it is strongly recommended to undergo a functionality test to ensure that the various components are working as intended. Before continuing make sure that your instrument is connected as described in [Initial Ethernet Connection](#). The Functionality Test procedure also assumes that you are familiar with the Deployment Software as described in the [Deployment Wizard](#) section.

First we need to create a .deploy file which preferably samples at the maximum rate. To do so select all the default options except Average interval and Measurement interval which should be set to the lowest common value.

Once connected, select **Online > Start Data Collection**, and select the .deploy file we just created which will start real time sampling. An easy way to tell if the instrument is sampling is to check the LED which will blink every time a ping is sent by the instrument.

Once the instrument is sampling you will find information regarding the various sensors in the main screen, refer to [Online Data Collection](#) for more information.

First check that your firmware version is up to date with the Nortek [software page](#). When you purchase a brand new instrument, it has a firmware version matching the PC software, hence no

firmware upgrade will be needed before you start using the instrument. However, new functionality (and bug fixes) is likely to be offered in the future, requiring that the firmware be updated. New firmware is posted on the Nortek [software page](#). Download the version corresponding to your instrument type. Click **Instrument > Firmware Upgrade** and follow the on-screen instructions. **You must reformat and reboot the instrument after every firmware upgrade.**

Note: If you leave the instrument collecting data using the internal batteries it will run until depletion. Always make sure to stop data collection when testing is complete.

Temperature

To test the temperature sensor simply read off the corresponding value and compare with your room temperature.

Pressure

The pressure sensor outputs the absolute pressure value in units of dBar. During production, the sensor is adjusted to 9.5 dBar to output the gauge pressure (pressure relative to the atmospheric pressure). The pressure sensor cannot output negative values. The outcome is that when the instrument is in air, you will see a value of 0.2-0.7 dBar, depending on atmospheric conditions.

Test the pressure sensor by submerging the instrument in approximately 0.5 m of water. The value should read 0.5 dBar + the ambient pressure of 0.2-0.7.

An alternative way to test whether the sensor is functioning is by forming a seal around the sensor with your mouth and blowing to observe an increase in pressure.

Tilt

1. Find the X mark located on the instrument and identify which direction it is pointing.
2. Hold the instrument as level as possible while aiming the X direction away from you. The values for "Pitch" and "Roll" should now be close to zero.
3. Tilt the instrument 10° to the right. The "Roll" value should read approximately 10.
4. Tilt the instrument 10° to the left. The "Roll" value should read approximately -10.
5. Tilt the instrument 10° forwards. The "Pitch" value should read approximately -10.
6. Tilt the instrument 10° backwards. The "Pitch" value should read approximately 10.
7. Now turn the instrument upside-down, still aiming the X direction away from you. Repeat steps 2 - 6 and ensure you have the same values. Note that an AHRS-enabled instrument will read 180° when upside-down.

Note: While holding the instrument upside-down the Accelerometer Z value should read -1.

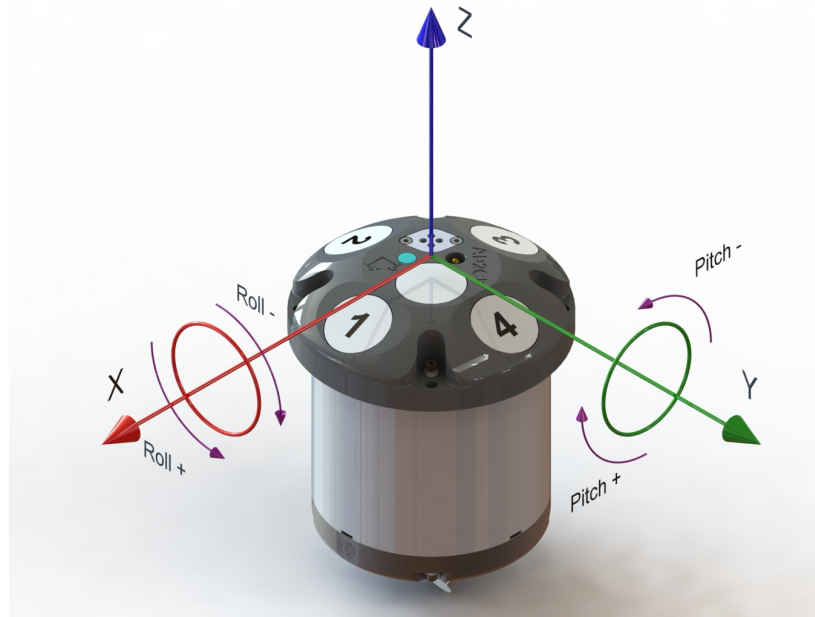

Figure 6. Definitions of beam number, pitch and roll

Compass

Point the X-direction towards North. Rotate the instrument around the Z-axis and check the values at 0, 90, 180, 270 degrees corresponding to North, East, South and West respectively.

Electromagnetic interference from magnets, metals, etc in the vicinity can interfere with the measurement so take this into consideration when evaluating the result. Check the [Compass Calibration](#) section for more information.

Amplitude

Each beam measures amplitude in dB and should be checked individually. Do this by shooting one beam at a time into water (or a water filled bag as in picture below), you should see a peak in amplitude corresponding to the individual beam number you are testing. The beams are numbered 1-4 starting with the beam facing the X-direction and going clockwise with the fifth beam in the center. Remember that you will need a license that covers fifth beam operation to test its functionality. The data from the fifth beam can be found in the raw data.

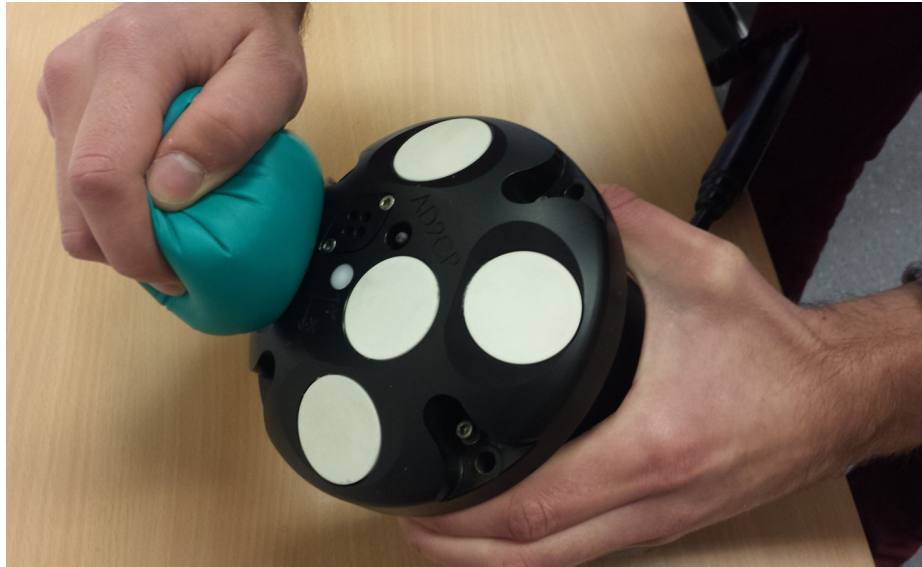

Figure 7. Example of an amplitude test. Covering one beam at a time with a water filled glove.

Check and record the noise floor (amplitude) for the instrument in air. Values should be between 20 and 30 dB, this will vary with bandwidth and frequency used. Submerge the sensor head and check the maximum amplitude, values should increase significantly. Since the instrument relies on scattering particles, clean water will give low returned signal strength. The purpose of the test is to see that the returned signal has a significant increase in strength relative to the noise floor. All the beams should have approximately the same values.

Note: Background noise is very prone to interference from nearby sources, such as a power supply. During testing make sure the instrument is far enough away from other electronics.

Correlation

Correlation values should be observed before the transducers are submerged in water and compared to the values while underwater. You should notice a significant increase.

Recorder/Memory

1. Test the recorder by selecting **Deployment > Start Recorder Deployment**.
2. Name the file "test" and start deployment. A notification may appear warning the instrument is running off an external power supply, press Yes to continue.
3. A popup confirming your deployment will appear, press OK. You will be taken back to the Home screen while the instrument is deployed.
4. After a few minutes, stop the data collection by reconnecting to your instrument.
5. Find the "test.ad2cp" file you created under **Deployment > Recorder Data Retrieval** and press the  icon.
6. Select **Deployment > Data Conversion** and find your downloaded "test.ad2cp" file using the **Add file** feature. Specify the folder you want to save the converted Matlab file in and press **Start**.

Note: If you leave the instrument collecting data using the internal batteries it will run until depletion. Always make sure to stop data collection when testing is complete.

Note: We recommend starting new deployments with an empty memory. Before you erase the recorder, make sure that you have transferred all the data you want to retain. Click **Deployment > Recorder Data Retrieval** and **Erase Recorder**.

4.2 Changing Batteries

The internal battery pack is located inside the housing. Note that the instruments are shipped with the battery disconnected.

You can estimate the power consumption before the deployment using the planning module in the [Deployment Software](#). We encourage using new batteries for each deployment.

To connect the battery pack for the first time or to replace it with a new one, follow the guidelines below.

<p>Remove any existing connections from the instrument. Place the instrument with the end cap facing up and remove the four bolts using the provided tool (see toolkit). Take a second to note how the end cap is matched with the housing (refer to image). The positive X-axis points in the direction of the labels.</p>	
<p>If the lid is stuck, use the supplied tools (see picture) and place them in a notch on each side of the canister. Twist in opposite directions to loosen the lid then slowly lift up the end cap.</p>	
<p>Disconnect the 3-pin (or 9-pin if serial communication) and 9-pin cables from the end cap. It may be necessary to have another person holding the end cap while disconnecting. Set the end cap aside and make sure not to scrape, damage or lose the O-rings. Remove the old batteries and slide the new battery pack carefully into the housing, making sure to thread the cables through the hole (see picture). Connect the battery harness (female) to the two 2-pin connector (male).</p>	
<p>Connect the 3- or 9-pin connector (female) to the end cap (male), to enable the use of an external battery canister. Connect the 9-pin to the end cap and check that the grounding cable (green/yellow) is fastened.</p>	
<p>Check the O-rings on the end cap are maintained as per described in the O-ring Care section. This is perhaps the most crucial step as it ensures the instrument does not leak in water.</p>	
<p>Make sure the end cap is oriented correctly as you put it back in place. Take special note that none of the wires are squeezed when placing the end cap.</p>	
<p>Loosely cross tighten each screw before tightening properly. Refer to the Securing Screws section for more detailed information. Note the washer and lock-washer sequence.</p>	



Note: You will need to do a new compass calibration after changing your battery as the magnetic interference will be different from before.

Note: The Signature500 alkaline battery pack holds 12 C cells and gives a nominal starting voltage of 18 VDC. The Signature1000 has 3*10AA cells and gives a nominal starting voltage of 15 V. The Signature250 alkaline battery pack gives a nominal starting voltage of 18 VDC. The voltage of alkaline cells falls quickly at the beginning, slowly during most of its life, then again quickly at the end.

When is the battery pack considered dead, you may ask. We do not have a clear cut answer, because the measured voltage of the battery will vary greatly depending whether a load is applied or if you measure just using a voltmeter. The internal Signature500 18 V batteries should be considered "empty/used" below 17 V and completely dead at 12 V if using a voltmeter. For the Signature1000, the corresponding numbers are 15 V, 14 V and ~12 V. The instruments will be able to measure < 12 V when a load is applied. The best way to estimate how much is left of the battery is to use the estimates given by the Deployment Software. For example: The internal Signature500 batteries are 180 Wh. With a configuration setup that uses approx 0.7 Wh per day, and a total run time ~126 days will lead to ~88 Wh used with ~90 Wh remaining.

External Battery Canister

The following procedure outlines how to connect the external battery pack or install a new one.

Remove the three screws and washers holding the end cap to the pressure case, and remove the end cap.	
Disconnect the 2-pin connector and pull the old battery out of the pressure case.	
Slide in a new battery and connect the connectors.	
Check the O-rings are maintained as per described in the O-ring Care section.	
Place the end cap and mount the three screws and washers.	
Test the instrument by collecting data without using an external power source to ensure that the battery is properly connected. Make sure to stop data collection so that the instrument will power down after the testing is finished.	

Note: Make sure to always include a desiccant bag in the housing and canister. Humid air can condense enough water to cause damage.

Check and follow local regulations about proper disposal of batteries (alkaline or lithium) as this varies between countries.

4.3 Guide rail harness removal

This section is relevant for Signatures with long housings that will be powered by Lithium batteries. With the Lithium batteries there is not enough room in the housing with the standard guide rail installed, so the solution is to remove it. The following describes the procedure.

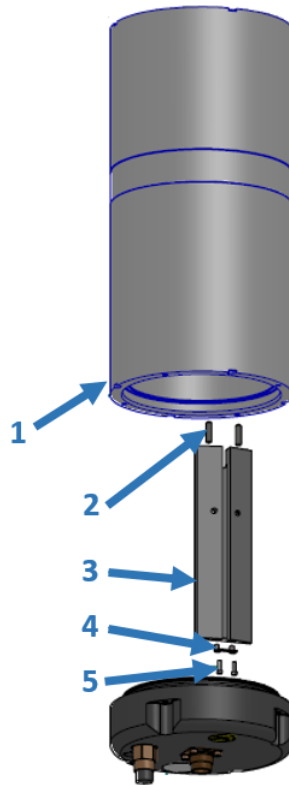

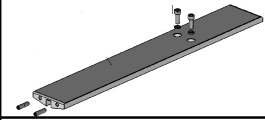

Figure 8: 1: Housing, 2: Set screws, 3: Rail, 4: Bracket, 5: Screws

Open the battery compartment as described in the previous section	
Remove the two screws (5) that fix the bracket (4) to the housing (1). (The numbering refers to the figure above)	
Remove the bracket, and carefully slide the guide rail harness (3) out. It is fixed to the base plate with set screws (2) so it should not be difficult to pull it out.	
The rail is secured with an extra set of screws and washers	
Connect the battery. Follow the guidelines in the previous section for details	

If the harness should still be secured to the side, the rail can be replaced by a piece of duct tape to make the installation of a new battery a bit easier.

4.4 Compass Calibration

The steps below applies both to instruments with a standard magnetometer and to those with the AHRS option.

1. Assemble the frame/buoy with the instrument, battery canister, extra ballast, etc. so as to simulate the intended deployment setup as closely as possible.
2. Connect the system to the computer. Click **Instrument > Compass Calibration**.
3. Be prepared to rotate the entire system slowly around the Z axis of the instrument. Click **Start**. Note that when doing this in the field, you cannot expect to produce a perfect circle. However, we recommend you to do this slowly, approximately 30 seconds per 360°, in an attempt to come as close to the ideal circle as possible.
4. After full rotation click **Stop**. If the data collected is suitable for calibration, the Quality indicator turns green. Yellow indicates an adequate calibration and red indicates a bad calibration. A good calibration will have a relatively flat Corrected Normals graph.
5. To use the obtained values, click **Update**. You will be prompted to confirm that the offset values shall be transferred to the instrument to serve as the new compass setting.

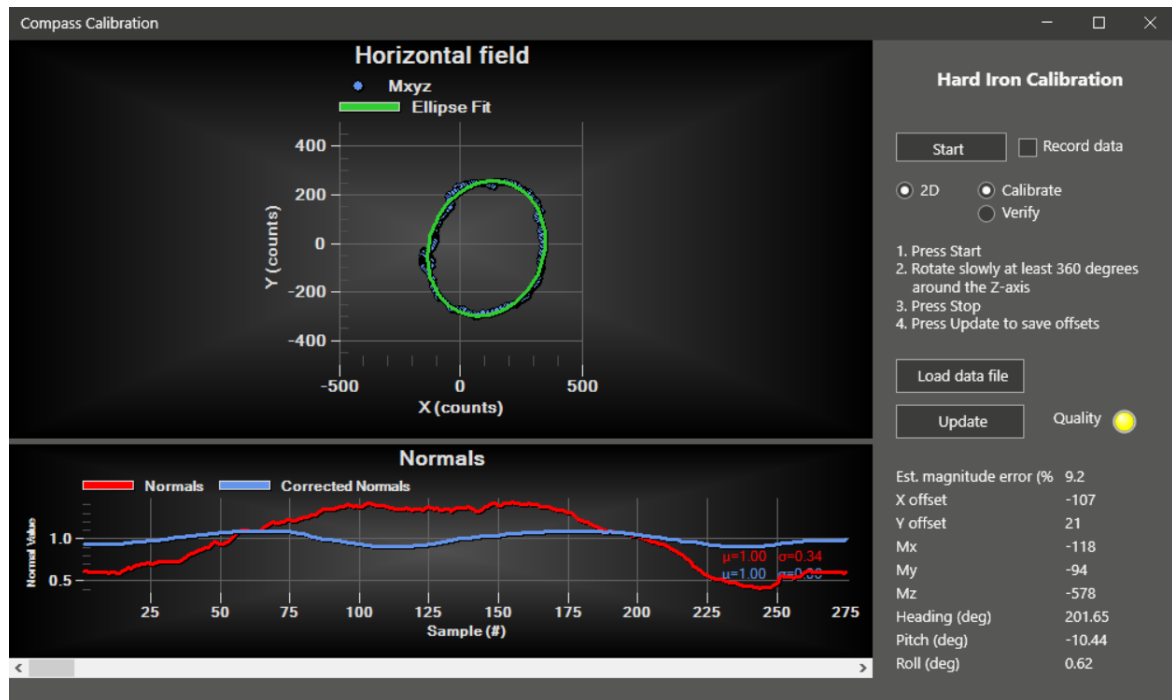

Figure 9. 2D Compass calibration dialog box

Typically you will see offsets coming from these two sources:

Hard Iron (X/Y offset): This will cause a shift in the position of the ellipse away from the origin (0,0).

Soft Iron (Mx, My, Mz): This will deform the ellipse.

After the instrument offsets have been updated the calibration can be verified by re-executing the data collection and rotation and ensuring that the circle produced is centered on (0, 0, 0) (and that the corresponding offset corrections are close to 0). This will verify that the hard and soft iron influences have been compensated for.

Ticking "Record data" will write the compass calibration values to a .txt file in the C:\...\Documents\Nortek\Deployment\Online folder, e.g. CompCalib_20210604T094001.txt). You can then use this file to apply the same calibration to the same or another instrument using "Load data file".

Note: Be aware of any material that may be disrupting the magnetic field in the vicinity during calibration as this may skew the directionality of your data. This is likely to occur at magnetic fields stronger than 5 Gauss. Velocities with respect to X, Y and Z and according to each beam will be correct but North, East and Up may be incorrect. If possible, do the final calibration before you board your vessel as ship decks tend to have non-uniform magnetic disturbances significant enough to disrupt the compass calibration process.

Note: Do not subject any part of the instrument, including batteries, to a magnetic field stronger than 20 Gauss. This may permanently damage the components and cause irreversible damage to the compass.

The raw data from the magnetometer and accelerometer are stored every time the compass direction is read. From a practical point of view this means that any instrument that has spun 360 degrees during a deployment can be calibrated for hard iron effects in post processing so long as you have the [Ocean Contour software](#). This avoids the problem of calibrating the compass before deployment and in principle makes it possible to achieve higher directional accuracy in the current velocity data.

Magnetic Declination

The compass calibration does not correct for magnetic declination at the deployment site. This must be added either before the deployment using commands (see the [Integrators Guide](#)), or after the deployment when post-processing in Ocean Contour.

4.5 Before Deployment

With the previous sections of this chapter successfully completed you are now ready for your final preparations before deployment.

- We recommend that you carefully plan the deployment setup and make yourself aware of the possibilities in the Nortek Deployment software. Simply select **Planning > Deployment Planning** to open the deployment settings. Here you are able to configure the settings without needing a live connection with your instrument. Set the deployment configuration as desired and click **Save configuration**. This will allow you to quickly load the settings onto multiple instruments and keep equivalent deployment settings time after time.
- For stand alone systems, it is vital to remember to connect the dummy plug to ensure the instrument is water tight. Before mating, ensure that the connectors are dry and free of debris, look for water inside the female connector.
- When properly mated, the engaging nut on the cable plug will thread smoothly onto the receptacle shell until it rather abruptly reaches a point where it cannot be hand-tightened any further. At this point the mating surfaces of the plug and receptacle are in contact, and have formed a good seal. The amount of force required to tighten the engaging nut should stay the same throughout (up until the point where it cannot be further hand-tightened). Otherwise, the connectors are not mating properly and will not form a good seal.
- Set a pressure offset. The instrument measures absolute pressure, and the pressure offset selected is the pressure reading for offsetting absolute to relative pressure. The factory setting is 9.5 dBar; this is chosen so that you always see a non-zero reading when the instrument is in air and can verify that the pressure sensor is functioning correctly. For reference, atmospheric pressure usually fluctuates around 10.13 dBar, and 1 dBar is equivalent to the pressure change over 1m depth in fresh water (so at 1m depth the absolute pressure would be 11.13 dBar).

- We recommend starting new deployments with an empty memory. Before you erase the recorder, make sure that you have transferred all the data you want to retain. Click **Deployment > Recorder Data Retrieval > Erase Recorder**. If the SD-card becomes full during deployment, the data will stop being written/saved. But it will continue to measure in case serial output is turned on.
- Depending on when you set your deployment start time it can be wise to check that the instrument has started sampling as planned. This can be done by checking the LED which will blink every time a ping is sent by the instrument.
- Be aware that if the deployment time has passed when the battery is connected, the instrument will resynchronize its data sampling according to the deployment time and the instrument configuration. This means you may have to wait for one average measurement interval or one burst measurement interval before the instrument starts to ping. When the instrument re-synchronizes, it will blink the LED once just after the battery is connected.
Example: the deployment is set to start at 12:00 with 20 minute measurements intervals, but the battery is connected at 12:10, the first measurement interval will start at 12:20.
- If you are using an internal and external battery the primary battery will be selected based on which has highest voltage.
- We recommend starting a deployment with fresh batteries. But if you want to estimate how much is left of a used battery the best way is to use the estimates given by the Deployment Software. For example: The internal batteries for the Signature500 are 180Wh. The last deployment lasted for 126 days and were using approximately 0.7Wh per day (this information can be found in the saved .deploy file). Then the remaining Wh of the battery is thus $180 - 88 \sim 90\text{Wh}$
- O-rings for the online connectors should be lubricated with silicone lubricant.

It is worth double checking your deployment settings and the structural integrity of your rig before deploying the instrument.

5 Software

The Deployment software has been designed to aid you in the planning, execution, recovery, retrieval and conversion of data collected. In addition to the information below, a description of the various elements on the screen (parameters, buttons etc.) will appear if you hover over the element in question (mouse-over-text).

The newest Deployment Software version is always available for download from [our website](#); check out the [Installing Software](#) section for more details.

5.1 Discovery Tool

The Discover configuration menu selection provides a means to locate and configure the network information for instruments without having to know the IP address of the instrument. All instruments found on the network are displayed.

- Highlight the instrument you want to connect to and double-click/use the Connect button.
- If you use a static IP address you can type it directly into the Discovery dialog and click Connect.
- If you connect to the instrument using serial cable, check the "Serial Port" box, select the correct communication port and baud rate. The default is 9600. Note that the latter will let you communicate with the instrument through the terminal window only.

Note that it may not be possible to "discover" instruments on networks that are connected to the local network through a router. Read more about this in the [Troubleshooting](#) chapter.

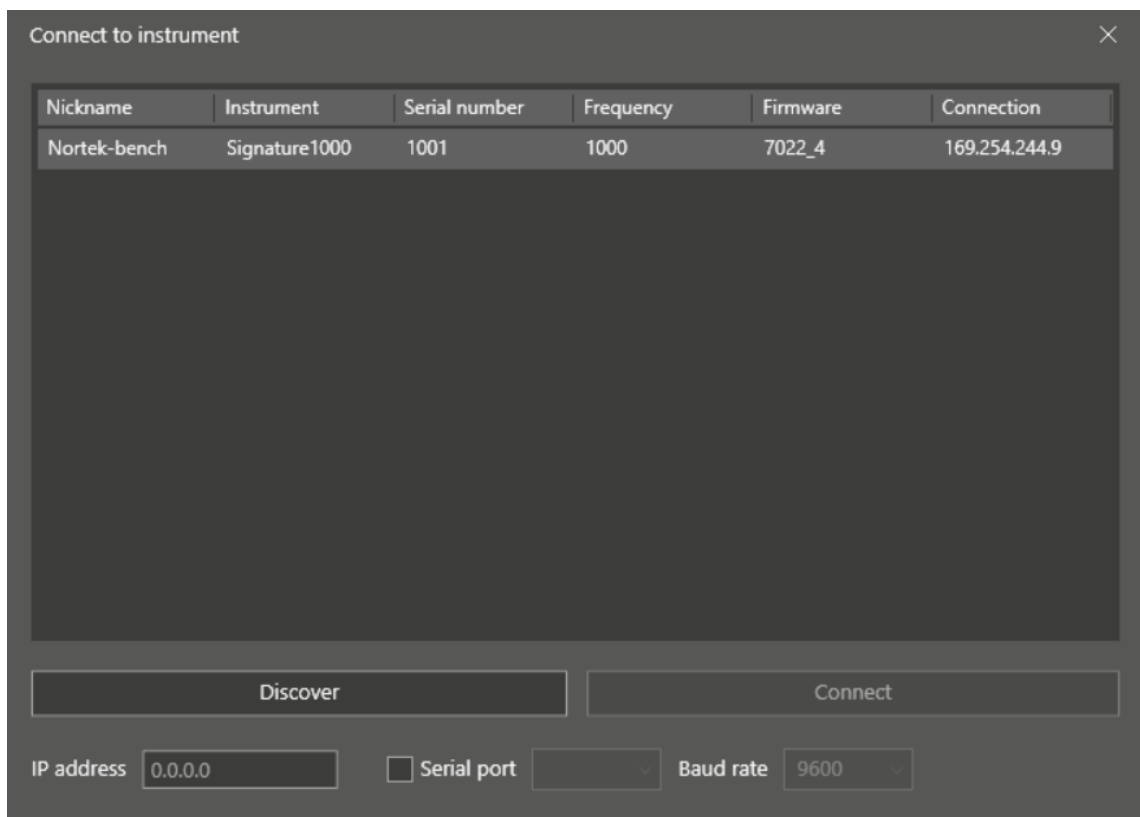

Figure 10. Discovery dialog box

- Instruments shown in the list that have a gray background will be possible to connect to.
- Only one person can be connected to an instrument at a time. If you try to establish connection with an occupied instrument, you will receive a notification.

- If an instrument has a red background, a notification box will give you information regarding the error. Refer to [Software Problem](#) chapter for information.

Right-click the highlighted instrument to get the option of using the Terminal Emulator (or press Ctrl+T, consult [Appendix](#) if needed). In the menu you also have the possibility to open the instrument specific web site or show the instrument logs (Deployment log, Instrument log, System log and SEC [Serial Ethernet Connectivity] log). There is also an alternative called "Network Configuration", which enables the possibility to enable/disable DHCP or set the IP address. The latter option is described in detail [here](#).

5.2 Deployment Wizard

The instrument is configured by clicking the **Plan** button or clicking **Planning > Deployment planning** in the menu line. The Deployment Planning is structured as a wizard which guides you through the necessary steps to configure the instrument successfully. It is possible to configure the settings for your deployment file without a live connection with your instrument.

The Deployment Wizard view is divided into three parts; Steps, Instrument and Effect (refer to screenshot below). The idea is that you follow the steps using the **Next** button (and **Back**, if you need to) and make the adjustments from the default options. The first three steps; **Instrument**, **Application** and **Environment** define the physical settings of the instrument. The remaining steps determine how and when the instrument measures. When you change the settings in one step, the default values in the following steps will also be adjusted.

The Effect field displays performance parameters that are automatically updated as you change the parameter settings. It is a good idea to keep an eye on the Effect during the planning, to make sure you do not violate any limits e.g. required precision of the data, power consumption or memory available. Parameters that are highlighted in yellow are meant to serve as notifications and warnings to the user. An explanatory tooltip will be displayed if the mouse is hovered over the parameter.

The planning will result in a Deployment file (.deploy). The instrument can be started directly from the Deployment Wizard (if you are connected to an instrument) by using **Deploy** or **Start Online** buttons. The .deploy file can be **saved** and then uploaded to the instrument before deployment, and this option will allow you to quickly load the settings onto multiple instruments and keep equivalent deployment settings time after time. The **Customize** option lets you save the file and open it in a text editor for further customization.

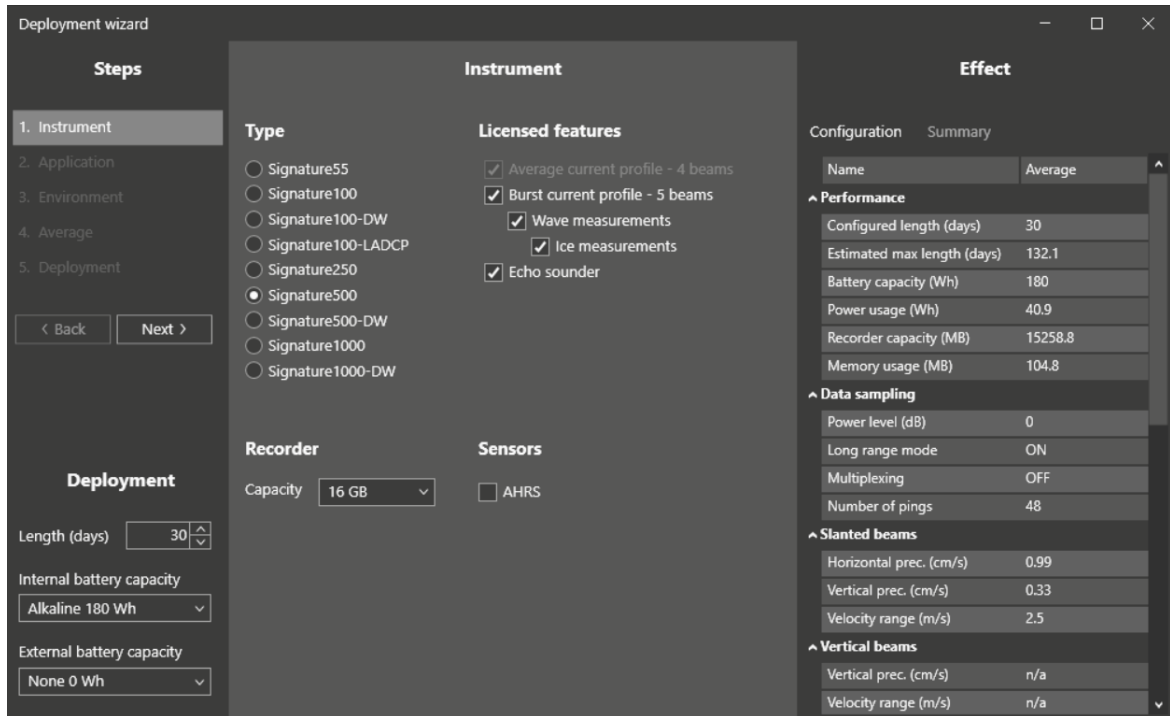

Figure 11. Deployment planning, step 1. Overview of the instruments and licenses.

Before going into the details of each step, here is an overview of the different parts of the **Effect** and **Summary** tabs.

Effect

Performance

Configured length (days)	Number of days you would like to collect data. This value, together with the other deployment parameters and the hardware configuration, will be used for calculating the performance parameters, i.e. power usage, recorder memory requirements and velocity precision.
---------------------------------	--

Estimated max length (days)	The deployment duration based on measurement parameters, hardware configuration and configured number of days.
------------------------------------	--

Battery capacity (Wh)	Total watt-hours as determined by the user.
------------------------------	---

Power usage (Wh)	The estimated power requirements as calculated by the firmware.
-------------------------	---

Recorder capacity (MB)	If no instrument connected; total capacity of the recorder in MB.
-------------------------------	---

Recorder free space (MB)	If instrument connected; unused space on the recorder in MB.
---------------------------------	--

Memory usage (MB)	The estimated memory requirements as calculated by the firmware.
--------------------------	--

Data sampling

Power level (dB):	Relative dB scale, where maximum power level is 0 dB. The maximum allowed power level varies with the configured profile range.
--------------------------	---

Long range mode	On or Off, varies with user requirements for range. In long range mode, more pings are required to reach the same velocity precision.
------------------------	---

Multiplexing	Only applicable for Signature250/100/55. Threshold at -6dB for on/off
---------------------	---

Number of pings The number of pings to be averaged together during the averaging interval. Important for velocity precision.

Slanted/vertical beams

Horizontal (cm/s) prec. A theoretical estimate of the precision of the velocity measurements based on how the instrument is set up. As a rule of thumb, this should be lower than 1/10 of the expected velocities in the measurement area.

Vertical (cm/s) prec. A theoretical estimate of the precision of the velocity measurements based on how the instrument is set up.

Velocity (m/s) range Maximum along-beam measurable velocity. Velocity range should cover the range of the velocities anticipated during the deployment. A velocity range set too high may result in more noisy data, and too low will mean that you will not be able to measure the highest velocities. If a range is set too short, it will result in velocity wrapping. This is based on the selected mounting method.

Measurement range

Desired range (m) Calculated based on instrument depth, up/down orientation and end of profile.

Configured range (m) Calculated based on end of profile and cell size.

Estimated range (m) Theoretical estimate. Based on "Geography", end of profile, cell size, power level and long range mode.

Blanking distance (m) Blanking is the time during which no measurements take place, to give the transducers time to settle before the transmitted signal returns to the receiver. This blanking reduce the interference from ringing based on the selected "Start of profile (m)"

Cell size (m) Specifies the vertical length of each depth cell in the profile. Standard deviation of the velocity measurements is inversely proportional to the depth cell size (larger depth cells give smaller standard deviations).

Number of cells Number of depth cells to collect per profile. The maximum number of depth cells with accurate velocity data will vary with system frequency, depth cell size and deployment conditions

Number of beams Number of active beams with selected configuration.

Altimeter Vertical distance measurement On/Off

Ice drift Tracking of ice on/off.

Pulse distance Related to HR settings. See below.

Altimeter start (m) Altimeter start of measurement distance

Altimeter end (m) Altimeter end of measurement distance

Sampling rate

Measurement interval Describes how often the instrument will collect data.

Configured average interval Specifies how long the instrument will be actively collecting data within each Measurement interval

Actual average interval Specifies how long the instrument will be collecting data within each Measurement interval. Differs from the Average Interval to allocate the Number of Pings correctly within it.

Sampling rate (Hz) Number of samples to collect per second.

#Samples Number of samples to collect each burst interval

Burst duration (s) The duration of one burst, defined by #Samples/Sampling Rate.

Summary presents a summary of the deployment based on the selections made. Some parameters are presented in the previous table.

Performance

Min configured baud rate	The minimum required baud rate, based on the amount of data being transferred (in turn based on measurement plan, number of cells, etc.)
Max RS422 cable distance (m)	The maximum length of an RS422 cable that can be used, based on the configured baud range

System information

Instrument name	Type of instrument, e.g. Signature1000
Nickname	The identifier given to this particular instrument
Serial number	The serial number of the instrument
Head frequency (Hz)	The frequency of the transducers on the head
Opt. sensors	Any additional sensors that have been added, e.g. AHRS
Firmware version	The currently installed firmware version
Recorder size (GB)	The size of the installed and licensed recorder
Connection	If Ethernet: IP address of instrument. If Serial: connected COM port.
Orientation	How the instrument is determining its orientation, e.g. Auto Z up/down

Application (see below for definitions)

Environment (see below for definitions)

[chosen measurement regime] (see below for definitions)

Step 1. Instrument. Refer to screenshot above.

- Select the type of instrument that shall be used. If the Signature is connected, that will be the only alternative available. Licensed features available for this particular instrument will be listed, the same applies to the Recorder.
- Licenses: Available functions. Contact Nortek if your measurements require other licenses.
- Recorder Capacity: Lists the recorder options.
- Sensors: AHRS (Attitude, Heading, Reference Sensor - requires additional hardware). Enable if the instrument is to be deployed in a dynamic environment.
- Deployment length (days): Enter the number of days you would like to collect data. This value, together with the other deployment parameters and the hardware configuration, will be used for calculating the performance parameters, i.e. battery utilization and recorder memory requirements.
- Specify the type of battery used (does not apply for online deployments). This is used to calculate power usage.

Step 2. Application. Select between Single and Concurrent plans. For the Signature500 and Signature1000 Alternating plans are also enabled. Check out the Appendix for a short overview of each application.

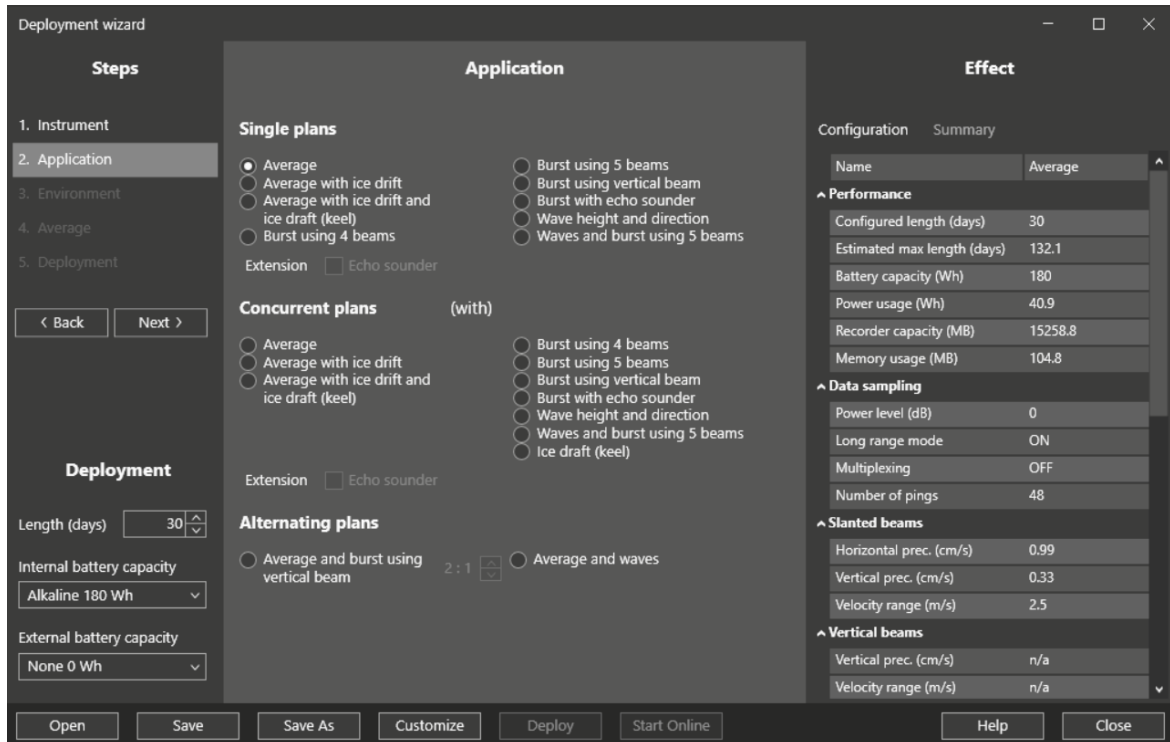

Figure 12. Deployment planning, step 2. Choose application.

- Single plan means that the instrument will measure selected sampling application at the defined measurement intervals.
- Concurrent plans enable different sampling schemes at the same time. The measurement duration and interval of concurrent plan no. 1 can be specified without taking much consideration of the second plan. See sketch below showing an example of a measurement sequence. The measurement interval and sampling rates are specified under step 4 and 5.

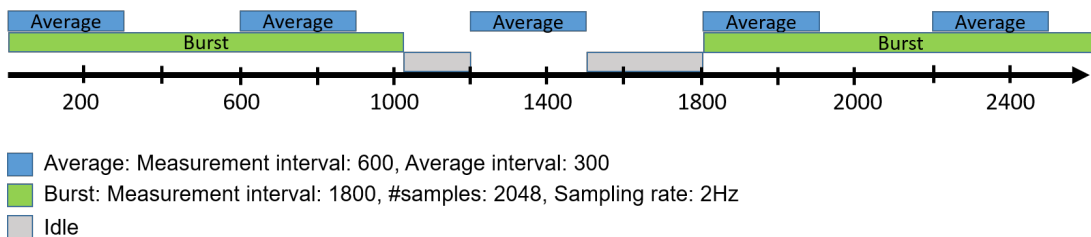
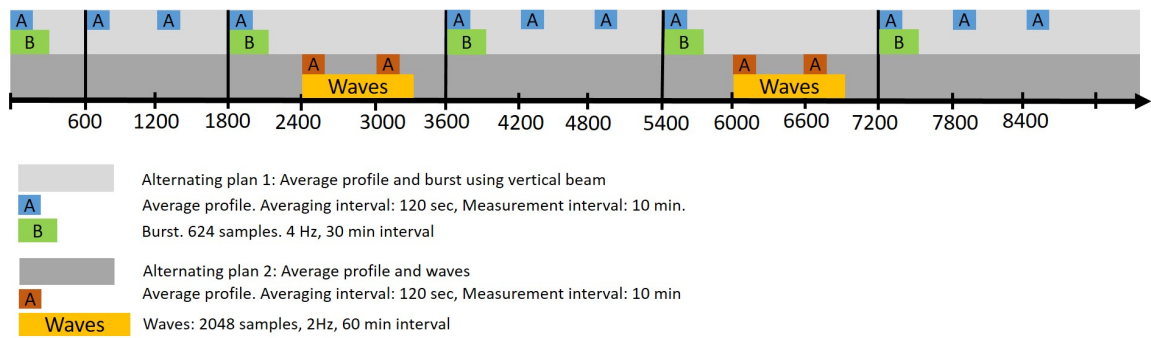

Figure 13. Visualization of a concurrent plan deployment setup, where the instrument samples bursts and profiles concurrently

- Alternating plans enables the possibility of alternating the sampling regime during deployment at a specified ratio. See example of measurement sequence below.



Ratio: Plan 1 = 2 * Plan 2

Figure 14. Visualization of an alternating plan deployment setup. The instrument alternates between measuring Current Profile & Burst and Current Profile & Waves, at a ratio of 2:1.

Step 3. Environment.

- Sound Velocity; Speed of sound can be set by the user (Fixed) or calculated by the instrument based on the measured temperature and a user-input value for salinity. The salinity is 0 for fresh water and typically 35 for the ocean. The instrument uses the speed of sound at the depth of the transducer to scale the Doppler frequency shift to velocity.
- Deployment: Specify if the instrument is looking upward or downward during the deployment, and estimate the distance to the bottom/surface. If the surface or the bottom is within the range of the instrument, this distance is used to configure the profiling range.
- Mounting: Choose the settings that best fits your deployment, which affects the velocity range.
- Geography: Choose the settings that best fits your deployment. This selection suggests a suitable power level and the long range mode for current profiling.
- Wave Climate: Check if strong waves are to be expected which affects the velocity range. Also specify the expected tidal range which helps configure the number of cells in the next step.

Velocity range: The velocity range reported by the Deployment software is the along-beam velocity range, which translates to a horizontal velocity range of $VR/\sin(\theta)$, where VR is the reported along-beam velocity range and θ is the beam slant angle. For example, a Signature1000 with a VR of ± 5 m/s and a slant angle of 25° will have a horizontal velocity range of ± 11.83 m/s.

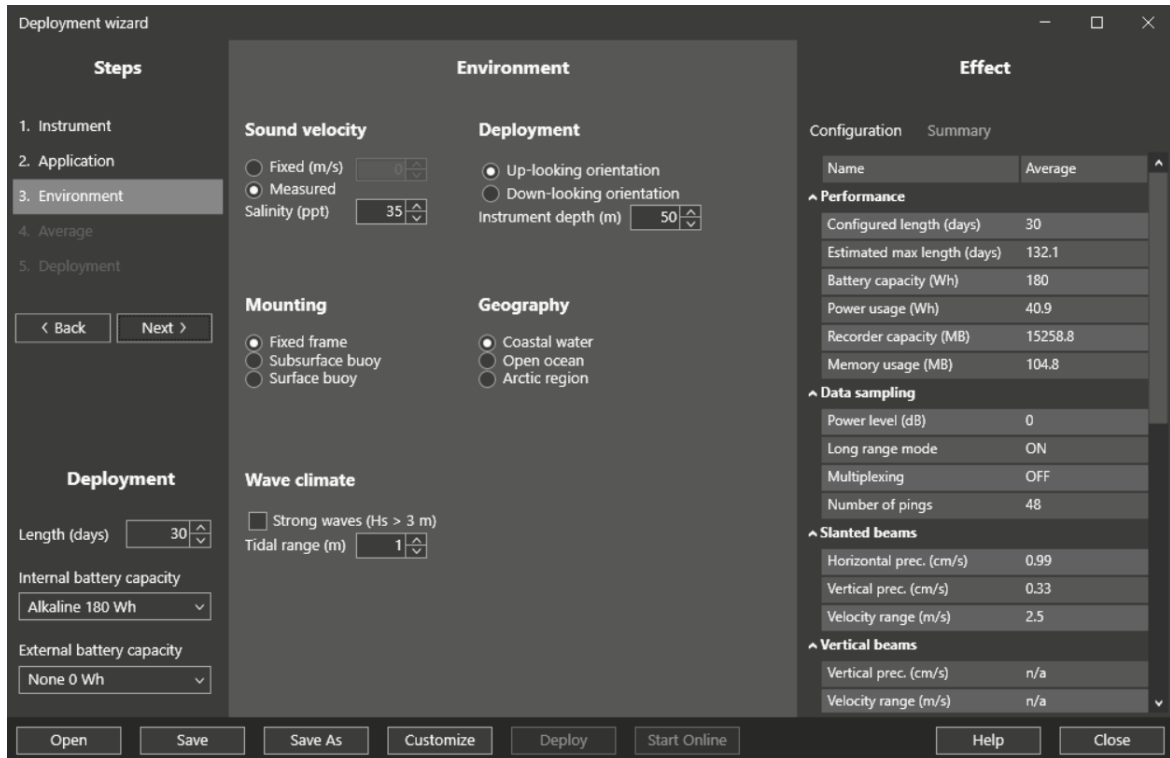

Figure 15. Deployment planning, step 3.

Next steps (depends on Application)

Average

- Range:
 - The instrument measurement region starts at Start of Profile (meter from the transducer) and ends at End of Profile. The Start of Profile defines the blanking distance
 - Cell size is the vertical size of the individual cells in the profile, in meters. A larger cell size will make the instrument transmit more energy for a given power level.
 - Power level should be set to match the desired Estimated max range or exceed it with a desired margin.
- Sampling:
 - Averaging interval specifies how long the instrument will be actively collecting data within each Measurement interval. Example: Measurement Interval is set to 600 seconds, averaging interval set to 60 seconds means that the instrument will collect data for 1 minute every 10 minutes. Averaging Interval must be smaller than or equal to Measurement Interval.
 - Measurement load: Within each second, the instrument can either be in active mode (collecting data) or in idle mode (not collecting data). The Measurement load is the relative time spent in active mode within each second and can have value from minimum (one ping) to 100% (always in active mode). With the Auto option selected, the program will automatically calculate an appropriate measurement load based on the averaging interval and the corresponding horizontal precision. Measurement load should be used as a configurable trade-off between precision and battery usage.
- Options: Select a coordinate system as desired. Changing the coordinate system can always be done in post-processing. Telemetry data format determines if serial output is enabled and which data format is used. Consult our System Integrator's Guide for more details about the Telemetry file. Enable serial output if you want the data out on the Ethernet or serial port.

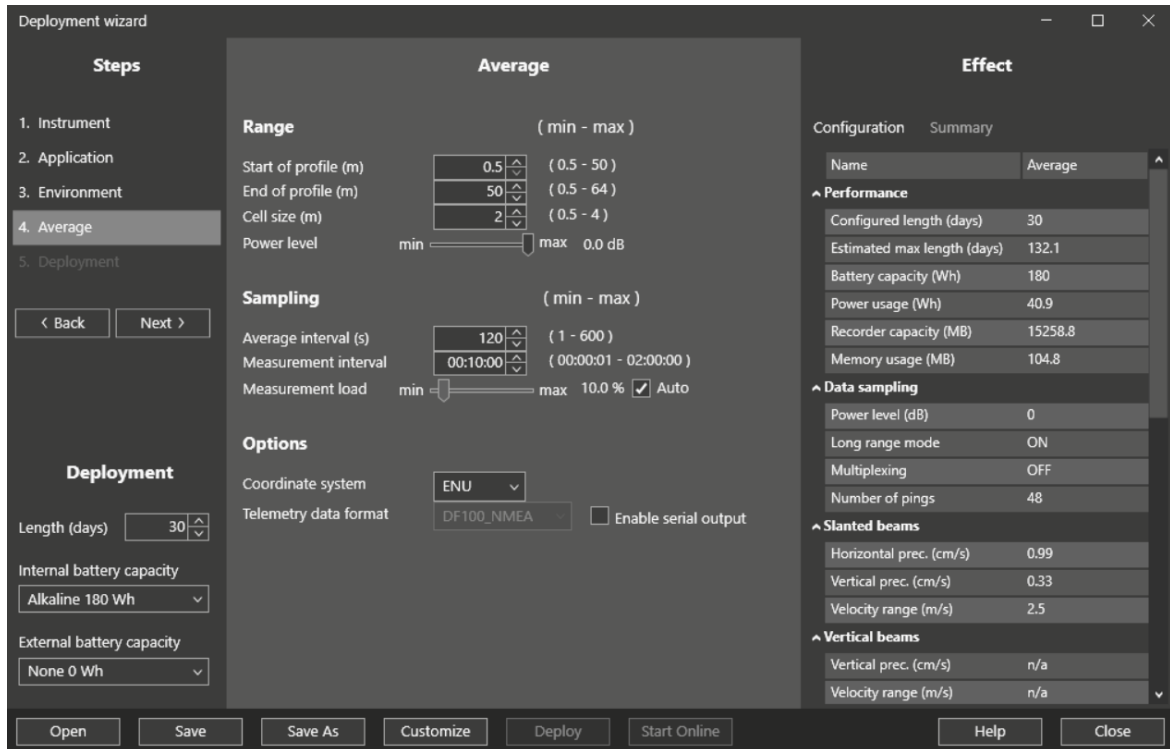

Figure 16. Deployment planning, step 4. Configure measurement regime.

Burst: similar settings as Average, except:

- Sampling:
 - Measurement interval determines how often the measurement scheme cycle should restart.
 - #samples: Number of samples to be taken within the measurement interval.
 - Sampling rate: Number of samples per second.
 - Measurement load: Within each second, the instrument can either be in active mode (collecting data) or in idle mode (not collecting data). The Measurement load is the relative time spent in active mode within each second and can have value from minimum (one ping) to 100% (always in active mode). With the Auto option selected, the program will automatically calculate an appropriate measurement load based on the averaging interval. Measurement load should be used a configurable trade-off between precision and battery usage.

Deployment wizard

Steps

- Instrument
- Application
- Environment
- Burst**
- Deployment

< Back Next >

Deployment

Length (days)

Internal battery capacity
Alkaline 180 Wh

External battery capacity
None 0 Wh

Burst (min - max)

Range

Start of profile (m) (0.5 - 50)

End of profile (m) (0.5 - 64)

Cell size (m) (0.5 - 4)

Power level min max 0.0 dB

Sampling (min - max)

Measurement interval (00:00:01 - 06:00:00)

#samples Continuous (1 - 14400)

Sampling rate (Hz)

Measurement load min max 100.0 % Auto

Options

Coordinate system

Effect

Configuration	Summary
Name	Burst 1-5
Performance	
Configured length (days)	30
Estimated max length (days)	29.1
Battery capacity (Wh)	180
Power usage (Wh)	185.3
Recorder capacity (MB)	15258.8
Memory usage (MB)	1760.6
Data sampling	
Power level (dB)	0
Long range mode	n/a
Multiplexing	n/a
Number of pings	1
Slanted beams	
Horizontal prec. (cm/s)	7.34
Vertical prec. (cm/s)	2.42
Velocity range (m/s)	2.5
Vertical beams	
Vertical prec. (cm/s)	4.6
Velocity range (m/s)	2.5

Open Save Save As Customize Deploy Start Online Help Close

Figure 17. Deployment planning, step 4.

HR: Relevant for Signature1000 with High Resolution (HR) license. Similar settings as Average, except:

- o Lag beam 5 (m): Time between two transmit pulses. The profiling range cannot exceed the time between the pulses, which means there is a coupling between the profiling range and the max/min velocity that can be measured. The resulting velocity range is reported under effects. When looking up towards the surface the lag should be set to half the distance to the surface to account for waves. When looking down towards the bottom the lag should be set to the distance to bottom. In open water, the lag can be increased as long as the velocity range is sufficiently high.

Waves, Waves and Burst: similar settings as Burst.

- o Range; Power level: Specifies how much acoustic energy the instrument transmits into the water. If disabled, the configuration uses the same power level as for the current profile.

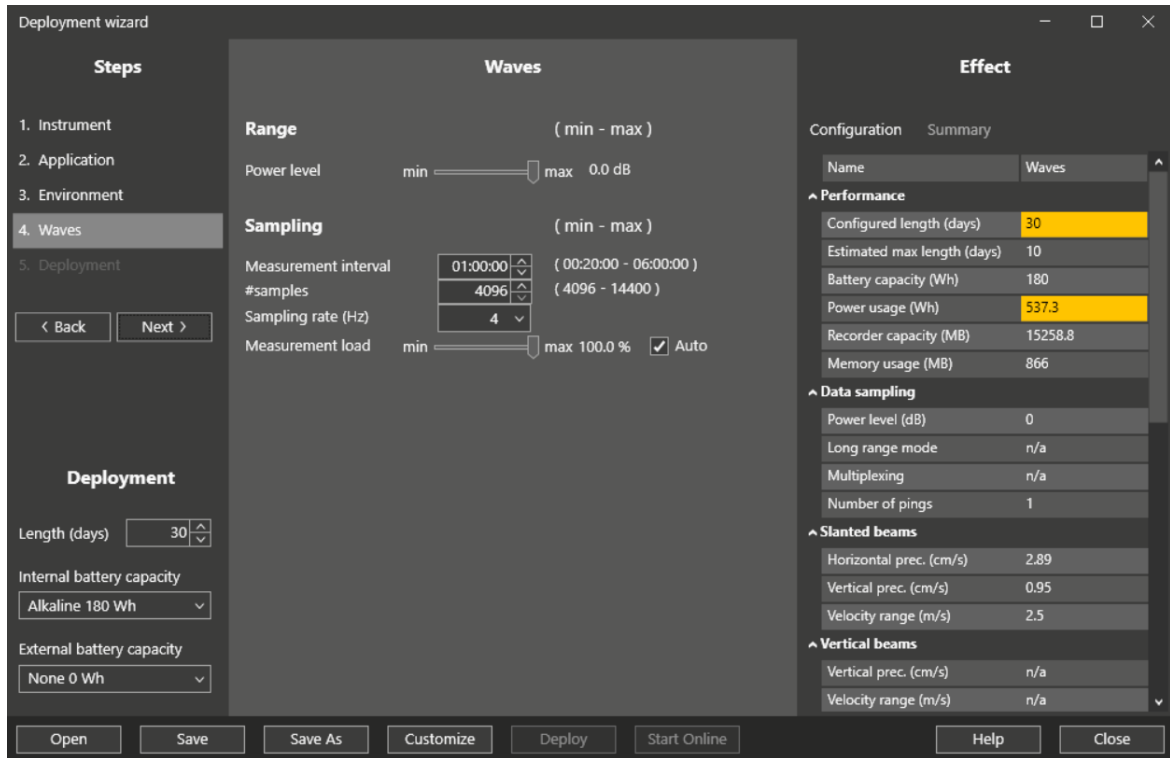

Figure 18. Deployment planning, step 4.

Ice draft (keel): Relevant for Signature250 and Signature500

- The altimeter measurement region starts at Altimeter start (meter from the transducer) and ends at Altimeter end.
- Measurement interval: how often a single ice thickness measurement will be done.
- Store echo data: how often raw altimeter data will be stored (in increments of measurement interval).

Echo Sounder: Relevant for Signature 500 and Signature1000

- Range
 - The measurement region starts at Start of Profile (meter from the transducer) and ends at End of Profile. The Start of Profile defines the blanking distance
 - Cell size is the vertical size of the individual cells in the profile, in meters. A larger cell size will make the instrument transmit more energy for a given power level.
- Echogram
 - Echogram can be combined so that the instrument measures both with and without pulse compression, or with different strength on the transmit pulse (transmit length). It is possible to enable three Echograms, but only one of them may be using Pulse compression. If unsure about what to select, it can often be a good idea to enable one echogram without pulse compression and another echogram with pulse compression enabled. Then you get both results at the same time and can decide later which one to use.
 - Transmit length with pulse compression: With pulse compression enabled, the center transducer transmit a sound wave (pulse) with a bandwidth of 25% (compared to the normal 6.25%). Changing the transmit pulse length when using pulse compression can increase the SNR at the expense of the power consumption. The resolution is not affected as the cell size will be equal to the configured value. Note that pulse compression may in some circumstances suffer from sidelobe effects but generally, this is not a problem.
 - Without pulse compression: The length of return echo will be a convolution of the rectangular transmit pulse and receive window. If the transmit pulse length is set to $\text{cell size}/(c/2)$ or

nominally cell size/750, the cells will consist of triangularly weighted echoes, similar to the classical ADCP cells. In this case the resolution depends on both the length of the transmit pulse and the cell size. The best resolution is achieved with the shortest allowable transmit pulse but still limited by the bandwidth which corresponds to a resolution of 12 mm for the Signature1000 and 24 mm for the Signature500.

- Store Raw Echo Data (under the Burst tab)
 - "Store raw data" enables the storage of the demodulated in-phase and quadrature components of the echosounder signal. These data are used when calculating the echograms output by the instrument and enable replication of the instrument algorithms in post-processing as well as implementation of other processing schemes. They can be very useful during echosounder calibration since they can be used for very precise distance estimates to calibration spheres.

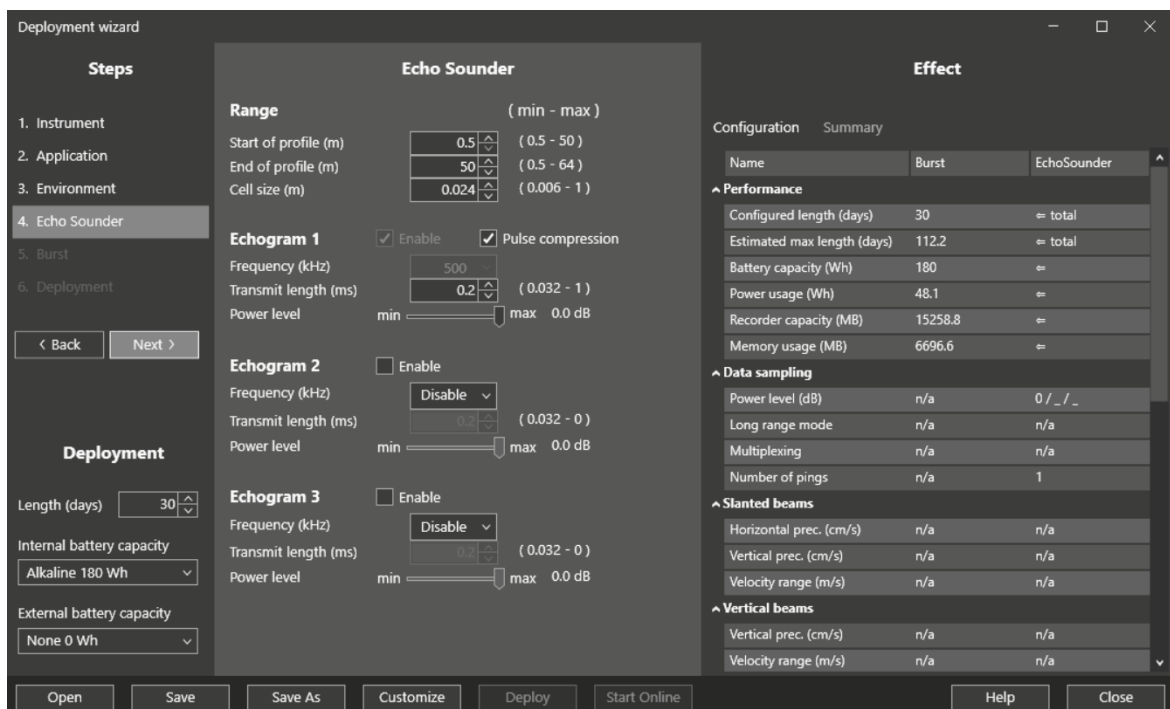

Figure 19. Deployment planning, step 4.

Final step: Deployment

When you are finished with the wizard, the configuration you have prepared must be saved as a deployment file. Define a name for the Deployment file you have prepared and add comments. The File menu configures where and how data are to be saved to the disk. The default filename is as follows: AD2CP_Instrumentfrequency_serialNO_DeploymentName.deploy.

5.3 Stand-Alone Deployment

A deployment sequence is started by clicking the **Deploy** button, and you will be prompted to select which deployment file to use. This activates a summary of the configuration:

Name	Average	Burst 1-4
Performance		
Configured length (days)	30	= total
Estimated max length (days)	8.7	= total
Battery capacity (Wh)	90	=
Power usage (Wh)	14	298.8
Recorder free space (MB)	15242.1	15242.1
Memory usage (MB)	24.6	2176.9
Data sampling		
Power level (dB)	0	0
Long range mode	OFF	n/a
Multiplexing	OFF	n/a
Number of pings	13	2
Slanted beams		
Horizontal prec. (cm/s)	0.97	5.19
Vertical prec. (cm/s)	0.32	1.71
Velocity range (m/s)	2.5	2.5
Vertical beams		
Vertical prec. (cm/s)	n/a	n/a
Velocity range (m/s)	n/a	n/a
Measurement range		
Desired range (m)	20	20
Configured range (m)	21.2	21.6
Estimated range (m)	23.7	20.9
Blanking distance (m)	0.2	0.1
Cell size (m)	1	0.5
Number of cells	21	43
Number of beams	4	4
Altimeter	OFF	OFF
Ice drift	OFF	OFF
Pulse distance	n/a	n/a
Altimeter start (m)	n/a	n/a
Altimeter end (m)	n/a	n/a
Sampling rate		
Measurement interval	00:10:00	01:00:00
Configured average interval	00:02:00	n/a
Actual average interval	00:01:57	n/a
Sampling rate (Hz)	n/a	4
#Samples	n/a	4096
Burst duration (s)	n/a	00:17:04

Deployment name:

Deployment time: Now

Synchronize clock to PC time

LED:

Figure 20. Deployment summary. The highlight presents relevant information

- Read through and verify that the set-up is as intended. This dialog box will confirm the selections made in the **Deployment Wizard**.

- The Deployment Name is by default the same as set in the final step of the Deployment Wizard, but it is possible to rename it.
- If you want the deployment to start some time in the future, set the date and time in the Deployment time field.
- The synchronize clock to PC time sets the instrument clock to the same as the PC clock. The purpose is to set the time as correctly as possible. The time reference is especially important in order to ensure proper synchronization between the instrument and other data sets collected independently. Time spent to properly set the time before a deployment can save a lot of time in post processing and analysis.
- The LED can be set to blink for every sample (On), blink for the first 24 hours of deployment (On for 24h), or never (Off).
- Press **Deploy** to send the configuration to the instrument.

The instrument connection will be closed during data collection, and you will be sent back to the Disconnected View of the software. The instrument is now properly configured and will stay in sleep mode until it begins its deployment at the scheduled time.

To stop the deployment, click **Connect**. Find the instrument in the Discovery feature and click the instrument you want to connect to. A notification will warn you that connecting to the instrument will stop data collection.

Be aware that if the deployment time has passed when the battery is connected, the instrument will resynchronize its data sampling according to the deployment time and the instrument configuration. This means you may have to wait for one average measurement interval or one burst measurement interval before the instrument starts to ping. When the instrument re-synchronizes, it will blink the LED once just after the battery is connected.

Example: the deployment is set to start at 12:00 with 20 minute measurements intervals, but the battery is connected at 12:10, the first measurement interval will start at 12:20.

5.4 Online Data Collection

An online measurement sequence is started by clicking the **Start** button, and you will be prompted to select which deployment file to use. Data collection will start immediately after the selected deploy file has been opened. After data collection has started, the **Stop** data collection is enabled.

If you want to record the online data, make sure to select **Record Data** under the Online menu before clicking **Start**. Otherwise, data are not saved on the recorder nor the computer hard drive during data collection. To find the data recorded to disk, click File > Open Online Data Folder.

The online data collection functionality in the SignatureDeployment software is intended mainly for function testing. For long-term deployments with real-time data output, enable data telemetry over the communications line using commands (see the [Signature Integrator's Guide](#)).

The online display window shows profiling and time series graphs for data currently collected by the instrument. Refer to screenshot below. The main display consists of two resizable panes. The top pane contains multiple tabular listings of measurement and status data. The bottom pane contains multiple chart and sweep plots of the measurement data. Different display groups are divided into tabbed windows to provide better viewing of the data. Use the time series row to select which data to display; either showing one cell at a time or a profile of one of the beams at a time. Certain data elements are displayed in a text pane. This displayed data is picked up live from the data stream as it is being collected (so no changes will be seen in this pane unless data collection is proceeding).

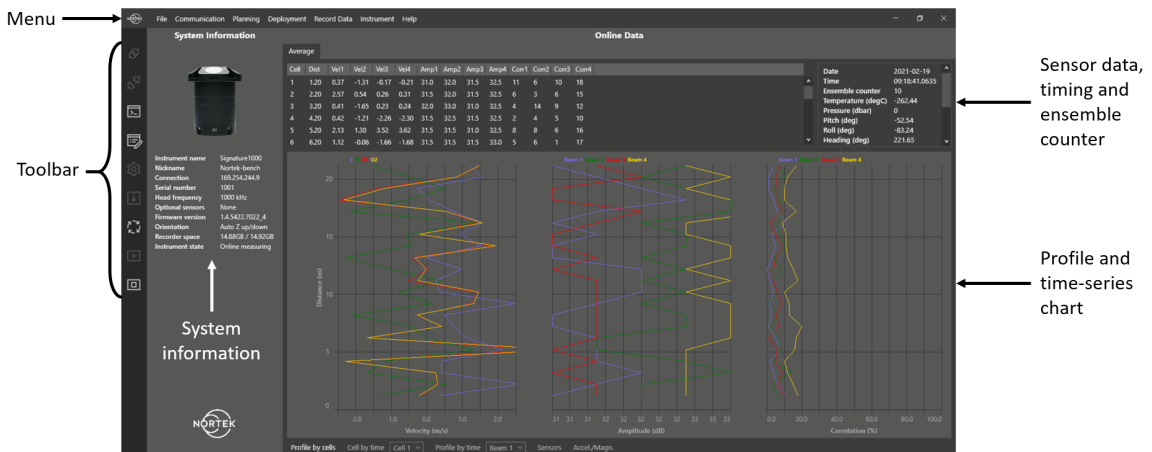

Figure 21. Overview of the main screen. This screenshot is from a Signature 1000 in air.

5.5 Recorder Data Retrieval

The **Data Retrieval** dialog box shows a list of all files currently stored in the recorder, including the time of the first measurement and the size for each file. The .cfg is the configuration file, the .ad2cp contain all raw data, stored in binary format. To allow the user to quickly investigate the results without having to download the full raw data file ([filename].ad2cp), an additional data file is stored containing only the averaged current data ([filename]_avgd.ad2cp). Only data where the correlation is above 50% will be included in the averaging, and the data will also include a percent-good value. Any bad data will be removed, or flagged with extreme values (e.g. -32.77 m/s). This averaging is only applicable to average mode; burst data will not be processed in this manner. "Percent Good" is defined as the percentage of data points above 50% correlation that go into an average ensemble.

Click the magnifying glass to see a summary of the deployment. Then download either all data (white arrow), or just the internally averaged data (_avgd.ad2cp file, dark gray arrow). The raw data downloads all single ping data. The file will be saved by default in the folder named Users\Use\Documents\Nortek\Deployment\Downloads, but this can be changed if needed. Multiple files can be downloaded at the same time. The "Show all" check box can be checked off if you want to see all files available on the recorder.

The firmware splits each deployment into 1 GB files, which are merged together when you download them. The "Download All" button will retrieve everything from the recorder but *will not merge the files*. You will need to use the white or gray arrows. It is not possible to change the maximum file size.

Erase Recorder

Click **Deployment > Recorder Data Retrieval > Erase Recorder**. It is good routine to do this in advance of every deployment as we recommend starting new deployments with an empty memory. Erase Recorder deletes the File Allocation Table (the list of files). This means that the data are not erased, they are made re-writeable. There is also the option to reformat the recorder under **Instrument > Format Recorder** which will delete everything on the recorder.

Note: Before you erase the recorder, make sure that you have transferred all the data you want to retain.

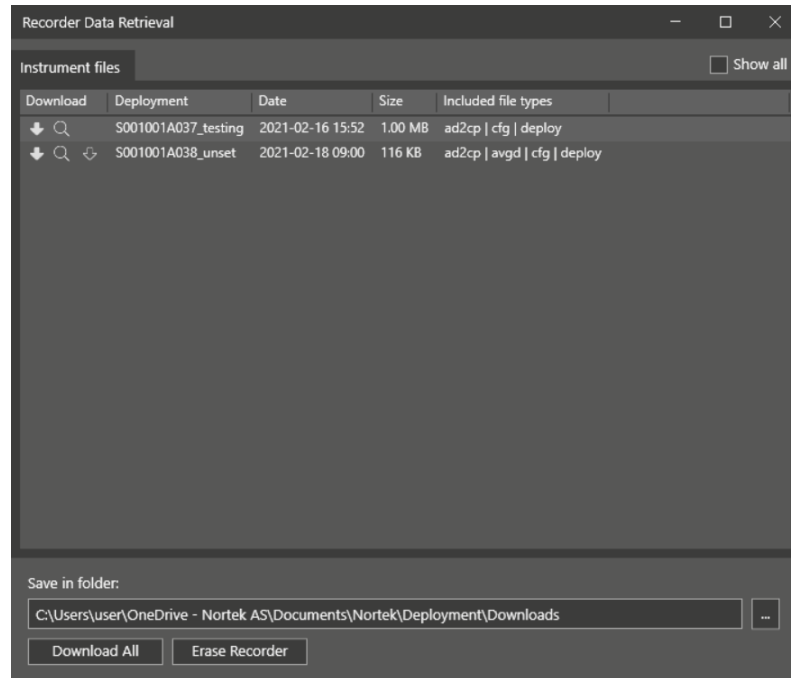

Figure 22. Recorder data retrieval dialog box

To find the downloaded data, click **File > Open Deployment Data Folder** or click the link in the dialog.

5.6 Data Conversion

The Data conversion menu is used to convert the proprietary binary data files (.ad2cp) into various formats. Multiple data files can be selected and converted at one time. Click **Add File...** This displays a file selection dialog box where you can select files to add to the Files to convert list. Press **Start** to initiate the conversion process. The converted data are located in the folder specified under "Save in folder". This path is also clickable.

Export to Matlab format result in .mat files which are directly readable by MATLAB. There is also an option to **Export to .PD0 format** which convert the file to standard PD0 binary format, or **Export to CSV format** which can easily be used with Excel. It is possible to select **Include coordinate transformations** which will automatically calculate the remaining two coordinate systems (e.g. if you chose ENU, then BEAM and XYZ coordinates will be included). Note that this will approximately triple the file size. The "Use 3D profile arrays" result in data saved in 3D arrays instead of 2D (which is the default).

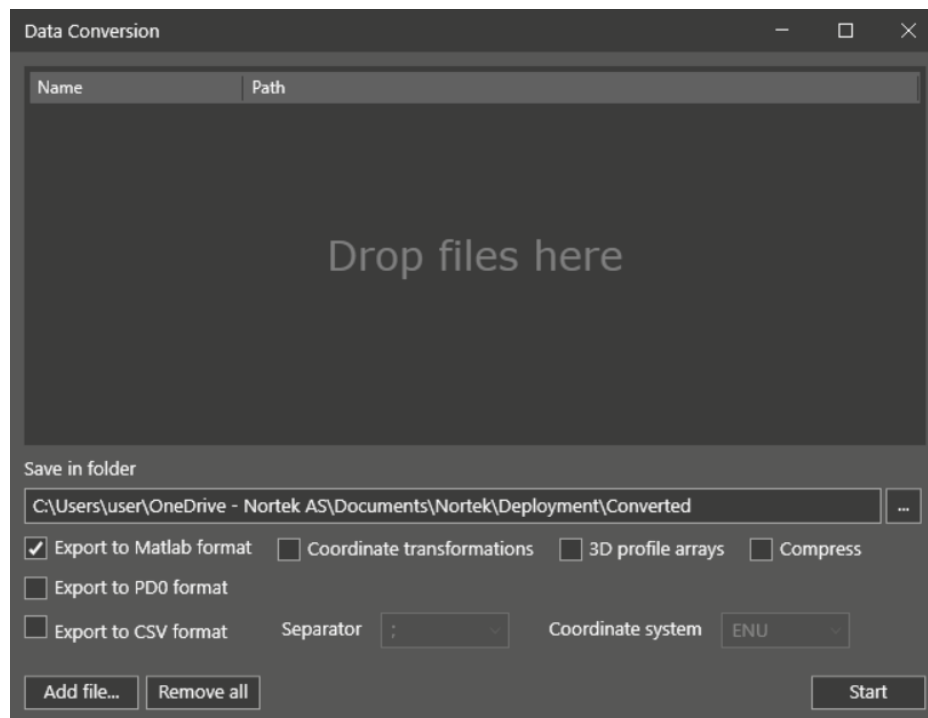

Figure 23. Data conversion dialog box

Data Format

.ad2cp and .cfg

The format of these data files are described in the System Integrator's Guide. The .cfg is the configuration file, the .ad2cp contain all raw data, stored in binary format.

.mat

Four structures are created. Data and Config contain sub-structures, Comments and Units that provide text describing the contents of the structures. Note that this operation can result in large amounts of RAM being used when processing large data files. Large data files will be broken down into multiple smaller .mat files by the export process. When multiple files are produced, “_#” will be added on to the file name prefix to identify each file portion.

.pd0

RDI Workhorse pd0 data format. See RDI documentation for details.

.csv

Comma separated values format. Each line is a data record, each column is described with the relevant header. Exports averaged data only for both raw .ad2cp files and _avgd.ad2cp files.

In order to get manageable file sizes out of the data conversion, there is a constraint of 50 Mb per file. The result is that the .ad2cp file will be separated into a number of sub files during conversion, depending on selected exported format and data size:

.mat and .pd0: Exports raw and averaged data, and these two types of files will be separated by an _avgd extension on the averaged data file. Large data files will be broken down into multiple smaller files, and _# will be added on to the file name prefix to identify each file portion.

.csv: Exports only averaged data, and the exported files will be separated into subfiles based on the configuration. For example, if you measure Current Profile and Burst, you can expect to get files with A0 and B0 in their names, respectively. If you in addition measure with alternating modes, you will see A0, A1, B0, B1. A0 and B0 contain Current Profiles and Burst data from the content of Alternating plan number one, and A1 and B1 is the Current Profile and Burst data from Alternating plan number 2. Other file identifiers are IB0 to denote Burst data from the vertical beam, and RAB0 to denote raw altimeter burst data. In addition, large data files will be broken down into multiple smaller files, and _# will be added on to the file name prefix to identify each file portion.

Note that the above may not be relevant for your specific instrument. The Signature250 does not have the option of alternating between two modes, and the Signature55 does not have concurrent measurement plans.

5.7 Post-Processing

The raw measurements captured by ADCPs often need to go through post-processing to yield usable datasets. The post-processing software intended for the Signature series of instruments is called Ocean Contour, and requires a paid-for license. If you would like a quote for the software, please contact your [local Nortek representative](#). Once you have a license, the software can be download from [our website](#).

Ocean Contour is a standalone, interactive desktop application that provides data visualization and processing capabilities for acoustic Doppler systems, specifically Nortek's Signature series, other AD2CP based instruments, and the Vectrino Profiler. Ocean Contour provides interactive QA/QC, data averaging and wave processing in addition to the display of all data products from the supported instruments.

5.8 Menus

The following commands are available on the main menu:

5.8.1 File

Open Documents Folder

Starts the Windows Explorer in order to find the folder where all the data files are stored.

Open Deployment Data Folder

Starts the Windows Explorer in order to find the folder where all the deployment data files are stored.

Open Online Data Folder

Starts the Windows Explorer in order to find the folder where all the online data files are stored.

Preferences

Sets the user data location and toggle for tooltips.

Exit

Disconnects from all instruments and exits from the application.

5.8.2 Communication

Connect to instrument

Initiates the Discovery feature which allows instruments to be found on the local network.

Disconnect from instrument

Disconnect instrument and returns the software to the startup screen.

Terminal Window

Access the Terminal Emulator to communicate directly with the instrument using commands. A simpler way to access the terminal emulator is to click Ctrl+T in the Discovery screen.

Open in Web browser

The AD2CP network processor runs a web server for displaying basic information about the instrument. To access the Web site, click here.

5.8.3 Planning

Recent deployments

Select a recently used deployment file.

New deployment

Starts the Deployment Planning wizard.

Open deployment

Opens the location where deployment files are saved.

5.8.4 Deployment**Start recorder deployment**

Initiates a deployment after selecting your .deploy file. Data will be stored on the instruments internal memory card.

Recorder data retrieval

After a recorder deployment the data (.cfg and .ad2cp file) will be available on the recorder for download.

Data conversion

The Data conversion menu is used to convert the proprietary binary data files (.ad2cp) into Matlab file format. Multiple data files can be selected and converted at one time.

5.8.5 Online**Start Data Collection**

An online measurement sequence is started by selecting your .deploy file. Data is collected over the Ethernet or serial cable and can be seen in the Deployment software in real time.

Stop Data Collection

Stops online data collection.

Record Data

Enable before starting data collection if you want the online data to be recorded to disk.

5.8.6 Instrument**Nickname**

Opens a text field to enter a (new) nickname.

Compass Calibration

Use this command to display the Compass Calibration dialog box that allows perform an on-site 2D or 3D calibration of the instrument compass to remove the effect of Hard-iron objects.

Firmware Upgrade

Use this command to download new firmware to the instrument. When upgrading the firmware, check to ensure that the most recent version of the application software is also used. Incompatible firmware loads will be detected by application.

1. Download the newest firmware to your computer from here: <http://www.nortek-as.com/en/support/software>
2. Click on Upgrade, select the relevant instrument and then browse to the downloaded firmware file and select it.
3. Click OK to start downloading the file to the instrument. This will result in the file being transferred to the instrument and a progress bar will be displayed

Erase Recorder

Deletes the File Allocation Table (the list of files). This means that the data are not erased completely, they are made re-writeable.

Format Recorder

This option will erase the recorder completely, not just the FAT as described above.

Set Pressure Offset

Set the pressure offset in dBar

Licenses

Add a new license to increase the available functions.

Show log

Use this command to display or edit the deployment log file.

Get Support File

Download the instrument support file (.tar.gz) containing debug information. This file is useful if you need support.

5.8.7 Help**Help**

Offers you an index to topics on which you can get help.

Manual

PDF versions of the Signature55/100 and Signature250/500/1000 operations manuals.

Release Notes

Open the software version release notes in your default text viewer.

Firmware release notes

Open the firmware version release notes in your default text viewer.

Nortek Web site

Open the Nortek home page in your web browser.

Check for updates

Check for more recent firmware or software versions, and select if this shall be done automatically.

Download Firmware

The firmware is bundled with the software.

Support Files

Download the software support file (.txt) containing debug information. This file is useful if you need support.

About

This item provides information about Nortek and how to contact us.

6 Mechanical Aspects and Maintenance

Preventive maintenance is your primary tool to keep your instrument in shape and ready for action and deployment. We recommend a regularly scheduled procedure which will act as a preventative measure to ensure your instrument continues functioning as intended. The following sections can be used as a maintenance guideline for the components that may be exposed to wear and tear.

We recommend conducting a Functionality Test after the maintenance procedure has been finished, to ensure that the instruments functionality is as expected. For AD2CP instruments, we also recommend adding an entry in the internal log that is kept within the instrument. This can be helpful in assessing service intervals etc. The "Add Deployment Log Entry" box on the Logs tab in the web interface can be used for this. This log will also keep a record of things like formatting or erasing the recorder and firmware upgrades.

DO NOT EXPOSE THE ELECTRONICS

In general, there should be no reason to expose the instrument electronics. **Do not open the housing to expose the electronics unless instructed by Nortek.**

Only qualified personnel are allowed to perform corrective maintenance activities. Please [contact Nortek](#) for further assistance if in any doubt.

6.1 Instrument Care

All Nortek instruments are intended for use in water. Other fluids may have an adverse effect on the materials used.

For prolonged storage at elevated temperatures close to the specified limit, or when temperature variation is uncertain, it is recommended that the screws securing the end cap be loosened in order to minimize the risk of any deformation due to temperature/stress over time (if your instrument has an accessible pressure case).

A preventive maintenance routine should include regular cleaning of the instrument. Use a **mild** detergent and pay special attention to the transducers. Do not expose any part of the instrument to harsh chemicals. Check the pressure sensor and remove any dirt from the holes in the cap. Be careful when opening the pressure sensor cap as it is easy to dent the sensor.

Do not use the molded head or endbell as a clamping surface, always clamp to the instrument housing.

When opening the instrument, great care should be taken to keep the sealing surfaces clean and protected from mechanical damage. Keep water out of the open pressure case. Both fresh and salt water can corrode the circuitry.

If the instrument has been subjected to environmental conditions outside the specified design limits (refer to the [Technical Specification](#) for your instrument for the limits), mechanical tolerances of non-metal components may be affected.

6.2 Connector Care

It is extremely important to keep connectors clean and well lubricated. Before plugging in connectors we recommend to always blast the pins with compressed air, inspect them for cleanliness and then protect the cable connector by applying a thin layer of silicone lubricating spray on the pins before you plug it into the instrument. We recommend the 3M Silicone Spray. Do not use the silicone grease included in the toolkit on connectors, as this is intended for O-rings only.

Before deployment:

- Demate the connector set.
- Flush both halves of the connector set with compressed air and remove any dirt.
- Check that both connectors are dry. If not, let them air-dry.
- Inspect for damage, corrosion and cuts.
- Apply a thin film of 3M Silicone Spray or equivalent.
- Mate the connector halves, and mate any unused connectors with dummy plugs. Ensure the rubber part of the female connector is properly seated over the pins before screwing on the locking sleeve.

After deployment and before storage:

- Flush both halves of the connector set with compressed air and remove any dirt.
- Check that both connectors are dry. If not, let them air-dry.
- Inspect for damage, corrosion and cuts.
- Mate with a dummy plug.

6.3 Cable Care

To keep your cables in good condition:

- Avoid nicks and cuts around contacts, as these are the sealing surfaces.
- Do not pull on the cable to disconnect connectors; pull the connector itself.
- Avoid sharp bends at cable entry to connector.
- Ensure that the cable is fixed to the mounting fixture to avoid mechanical stress to the connection.
- Elastomers can be seriously degraded if exposed to direct sunlight or high ozone levels for extended periods.

6.4 Replace Desiccant Bag

Humid air can condense enough water to do damage to the electrical circuitry. At least once a year, replace the desiccant located in the pressure case or the external battery canister. You may wish to replace the desiccant bag more regularly if the instrument is exposed to multiple significant changes in temperature (e.g. from a hot/humid surface environment to cool water). Refer to the battery installation procedure for your instrument for instructions on opening the pressure case.

6.5 O-ring Care

O-rings are the critical component that keeps water out of the housing and thus the instrument dry. Watertight sealing of the instrument housing is provided by double O-rings on the head and end cap sub-assemblies. The outer O-ring forms the primary seal and the inner forms a secondary (or backup) seal. If the integrity of the O-rings is degraded the instrument should not be re-deployed. In this case, [please contact us](#).

If the instrument has never been opened, O-ring inspection is not necessary. However, when changing batteries, the O-rings on the endbell are exposed. Make a routine of inspection, maintenance and replacement of exposed O-rings.

- Check the O-rings and the O-ring grooves for grit, hair, lint, sand, or anything that could potentially breach the O-ring seal.
- After frequent deployments or if O-rings or grooves appear dirty, remove O-rings and clean the grooves. To remove O-rings, use finger pressure or the rounded edge of a plastic card to lift the O-ring out of the groove. Caution! Never use a metal object to remove an O-ring. It may cause damage to the O-ring or the sealing surface.
- To check O-rings for damage, place the O-ring between the middle and index finger and thumb. Then pull the O-ring through your fingers, feeling for any debris or wear.
- If O-rings are dirty, it is best to replace them. Washing dirty O-rings with soap and water is not recommended. Soap breaks down the lubricants and will compromise the integrity of the seal.
- Properly greased O-rings will help maintain sealing integrity and minimize O-ring degradation. Use enough grease to lubricate the O-ring thoroughly, but not so much that it will attract additional debris.
- Clean the groove with a lint free swab or the folded edge of a paper towel.

NOTE: Do not open the transducer end on your instrument to check O-rings. Opening the whole instrument means exposing the electronics, and this shall not be done unless Nortek has approved and provided guidance on how to do it.

6.6 Securing Screws

When installing end caps and sensor heads, care should be taken when tightening the screws. Just a little tension on the screw is needed; when the O-ring starts to be compressed, turn each screw a little at a time until the O-ring is fully compressed.

Tightening one screw fully before continuing on to the next may cause improper O-ring seating and very high mechanical stress concentrated around the screw hole. This may cause leaks and/or damage to the head or the endbell. The screws need only be tightened sufficiently for the O-ring and spring washers to be fully compressed. Instead, use the cross tightening sequence: tighten one screw slightly, then move to the screw opposite. Tighten that one slightly, then change to the next pair of opposing screws and repeat. Continue in this pattern until the screws are sufficiently tightened.

Over-torquing has no positive effect and may damage the threads and/or area around the screw holes on the head and end cap. Keep in mind that ocean pressure holds the end cap tightly; all the screws have to do is to secure the end cap from falling out when the system is above water.



Figure: a) "Two-fingers" tightening of screws. Indicator arrow shows position before final tightening. b) Final tightening 30-45 degrees from "two-fingers" tightening.

6.7 Biofouling

Marine growth, or fouling, on moorings should be considered when planning long-term mooring systems. Current profilers used in long term monitoring projects will be covered with biological material. Eventually, the growth can become strong enough that the transducers are blocked and the profiling range is reduced. To know when to maintain the instrument it is best to monitor the long term variation in the amplitude data. This parameter varies with short time scales (depending on suspended sediment concentration, zoo plankton, bubbles, etc.), but biological growth (especially barnacles) adds a long term downward trend that can be monitored. The profiling range gradually goes down as the growth on the sensor increases. At some point, the signal strength will be too low to achieve the desired profiling range. Through experience you will gain knowledge about how long it takes before the transducers are covered and this information can later be used to set regular maintenance intervals where the transducers are cleaned.

When the instrument leaves the factory, the surfaces are quite smooth and it will take some time before any growth starts. After the first cleaning, the surface is rougher and it becomes easier for new material to grow. Typical maintenance intervals are 6-12 months, but the growth rates vary a lot with the geographical location, water temperature, season, and deployment depth. In general, heavy growth is seen in hot and shallow areas. Cold and deep water areas see very little growth so maintenance can be less frequent.

When calculating forces, the marine growth is accounted for by increasing the expected weight and diameters of the mooring line and all instrumentation attached, in addition to increasing the drag.

Antifouling paints and other agents are often used to avoid transducers being covered with barnacles or other evil crustaceans during long deployments. The important thing when it comes to antifouling is that the paint is not too thick, otherwise the signal strength may be affected. Nortek has tested the effect of antifouling paints on the profiling range of the 2 MHz Aquadopp and no appreciable change was found when a thin (1 mm or so) layer on the transducers was applied. You can probably use most anti-fouling paints as long as it is not too (chemically) aggressive and contains no solids (metal flakes, etc.) that could interfere with acoustic beams. Anodes and pressure ports should not be painted.

Nortek has run a test with three different zinc oxides, a zinc paste with 40% zinc oxide, Silulen (Nycomed) with 20% zinc oxide and Desitin (Pfizer) 40% zinc oxide. They all work quite well but the Silulen a little less so. Our conclusion from the test was that a higher zinc oxide percentage is probably better. Other options are use of thin plastic bag or Pettit's Trinidad anti-fouling paint (75.8% cuprous oxide). A different approach is to use an anti-fouling adhesive patch that covers each transducer. These patches have doubled deployment lengths in warm, biologically-active waters by keeping the transducers clear for longer and greatly increasing the required maintenance interval to remove biofouling. They have no detrimental effect on the quality of the measurements from covered transducers. Contact your local Nortek representative for more information.

We realize barnacles have to be removed mechanically, but we strongly advice against using sharp objects capable of harming the polyurethane surface. We also recommend staying away from strong organic solvents such as acetone. A common, easy, and inexpensive way to keep the Delrin housing on the Aquadopp and Aquadopp Profiler clean is to wrap the housing in either clear packaging tape and/or clear plastic wrap (such as the brand name "Saran Wrap"). At the end of the deployment, simply unwrap the protective coating to find a clear instrument. Tapes such as "Duct Tape" can leave a sticky residue that is very difficult to remove (although it does not actually harm the Delrin housing).

7 Troubleshooting

This section contains information in where to start looking if an instrument does not behave as intended. If you encounter a problem, you should:

- Get a good overview of the problem; make notes during the troubleshooting process
- Work in a systematic way and do not neglect the obvious. Start by looking at simple causes, such as power not connected, bad connections, etc.
- If the setup uses custom cables, power supply, etc. first assemble and test the instrument using the cable and battery (if applicable) that originally came with the instrument. You can always return to the standard setup, which is the easiest way to get the system to work, to confirm that the problems are not caused by a faulty instrument.
- If your instrument behaves strangely try updating both your software and firmware to the latest versions. There may be incompatibility between an older version of firmware and newer version of software, and vice versa. The latest versions of firmware and software can be downloaded from our support page at <http://www.nortekgroup.com/software>

To help us give good support, please:

- Be specific about the error - a screenshot is often helpful
- Include a raw sample file or a collected data set showing the error (.ad2cp)
- Include information about firmware and software version used
- Include serial number (Head ID, Hardware ID or order number)
- A **Support file** can be downloaded from the instrument and is used to assist you in the best possible manner. To retrieve this file, click **Instruments > Get Support file**. Alternatively, type in the IP address in the web browser and click "Retrieve Support File". A *.gz file is then downloaded and can be sent directly to Nortek for diagnosis.

If it turns out that the instrument will have to be sent back to Nortek for repair, check out the [FAQ on RMAs](#) for more information. Make sure to include all the information requested in the Proforma Invoice document. You can provide your own, or use our example shown in Appendix.

NOTE: Do not open the transducer end on the Signatures when doing troubleshooting. Opening the whole instrument means exposing the electronics, and this shall not be done unless Nortek has approved and provided a guidance on how to do it.

7.1 Communication

Instrument connected through Ethernet cable

- Does the Ethernet cable have a source of power?
- If the instrument is visible in the Discovery screen, try right-clicking and opening the Terminal Emulator. Send Break then Switch to Command Mode, a confirmation message should appear. Try connecting to the instrument as per normal.
- Consult the [Universal Plug and Play](#) section to find the IP address. Type this in the Discovery screen of the Deployment software. If you are able to connect, but it does not appear in the menu there may be an issue with the firewall. Try disabling your firewall and refresh the Discovery screen.
- Check network cabling connection: If your computer has light emitting diodes (LEDs) next to the connection where the Ethernet cable plugs into the computer, check if the LEDs are lit to indicate the current status of the network device. If the LEDs are not glowing/blinking, check that the connector is OK and try to re-plug. Refer to your computer's manual for information about the Ethernet port LED.

- Check the LED on the switch or router. The LEDs should be lit when there is a connection between the computer, the network router or switch and the instrument. If not, try switching it on and off to reset the switch/router.
- If an Ethernet switch is used, its Ethernet port should also show an active Ethernet link. Try connecting with a different cable. If not, there is a problem with the computer connection.
- If you have a button for turning on/off the wireless network antenna on your computer, turn this off.
- Connect the communication cable directly from the computer to the Signature instrument to bypass all of the network wiring and router. Is the PC showing that the link is active?
- If the connection was lost all of a sudden; run a test and analysis function in Windows (see step-by-step description below)



Figure 24. Ethernet port lights on computer.

Test and Analysis function in Windows

1. Click "Start"
2. Click "Control Panel"
3. Click "Network and Sharing Center"
4. Click "Change Adapter Settings"
5. Right-click "Local Area Connection". This icon represents your Ethernet connection to the instrument
6. Click "Diagnose." The analysis function in Windows will examine the failed connection and show an explanation of the problem and some advices to fix the problem

Unlike the serial port, once you have verified that the link is active, there is no need to do anything else with configuring the speed or other link characteristics. The next step is to make sure you have got an appropriate IP address assigned. For details about the process of assigning IP addresses, refer to the [Appendix](#).

Instrument is connected through serial communication cable

- Does the instrument have a source of power? Try using both internal and external battery/power source.
- Ethernet still connected and powered. The Signature will prioritize an Ethernet connection over a Serial connection, so if both cables are plugged in and powered only Ethernet will be available.
- Wrong serial port. Check that the correct serial port is selected. Go to Start - Control Panel - Systems - Hardware - Device Manager - Ports (look for USB device)
- Wrong baud rate. Try sending a break in the Terminal Emulator. If gibberish/non-sense or nothing, check the baud rate settings.
- Wrong serial protocol for the cable. Signatures can use both RS232 and RS422. Use the command GETINST,RS to check which protocol is enabled.
- There is a problem with the converter. Check that the LED on the converter is lit. If not, confirm that the correct driver is installed.

The blue LED indicator light on the instrument is not lit

- Is the instrument in Command mode?
- Does the LED blink (short) when applying power?

Cable

Cables are often exposed to heavy use and the power connector might break. Using a multimeter to ping through each pin may reveal a breakage.

Power Supply

The power supply supplied with the Signature series comes with a plug that it is possible to attach it incorrect. The Signature is protected by diode against reversal of polarity, but it will not power on.



Figure 25. Make sure the plug on the power supply is correctly fitted if it has been disconnected earlier

7.2 Network

Firewall

Firewalls are usually active by default and could be a possible cause for blocking communication.

For organizations with strong security / firewall restrictions, FTP access to the instrument may not be permitted. HTTP (Hypertext transfer protocol) can then be used for data transmission. A web page allowing individual data files to be downloaded has been implemented in the Ethernet processor. The web page can be accessed by clicking on the “Data Download (HTTP)” link from the main web page.

Routers

There are some limitations to the discovery protocol. Multicast Ethernet packets are used to implement the protocol and those packets may not be forwarded through routers (depending on the router type and configuration). For that reason, the instrument should be either directly connected or connected through a single Ethernet switch for troubleshooting. Once the IP address is properly configured, it can be used to access the instrument using normal IP communications. Only the discovery protocol uses multicast packets. For more details about the Ethernet communication, refer to the [Appendix](#).

IP address

You have the possibility to enable/disable DHCP and set a static IP address, if necessary. Check out [this appendix](#) for details.

7.3 Software Problem

Discovery tool; the instrument I want to connect to has red background. The instrument cannot be connected to because of one of the following reasons:

- Non compatible firmware. Go to Help > Download Firmware to get the most up to date version.
- Instrument is on wrong subnet. This can be fixed automatically by double-clicking the instrument name while in the Discovery screen.

- The instrument listed is not supported by the software.

If the Discovery feature does not list your instrument, refer to the [Communication Problem](#) section.

Software crash

- Download the support file containing debug information: **Help > Support files**
- If your instrument behaves strangely (for example error messages when trying to start data collection, compass calibration or pressure offset calibration), update both your software and firmware to the latest versions. There can be incompatibility between an older version of firmware and newer version of software, and vice versa. The latest versions of firmware and software can be downloaded from our support page.

8 Appendices

8.1 Glossary

Accuracy	A value giving the degree of closeness of a velocity measurement to the actual velocity. Refer to the data sheet for specific minimum accuracy.
AD2CP	Nortek's broadband signal processing platform.
AHRS	Attitude and Heading Reference System. Provide attitude information and replace the traditional tilt and magnetometer. AHRS is especially useful in dynamic environments. Note that this feature also requires additional hardware.
Altimeter	Measures the distance to the surface
Amplitude	See signal strength
ASCII output	Data is displayed in ASCII format (text).
Bandwidth	Wider signal bandwidth is used to get more information and improve the velocity precision. Reduced bandwidth is used in long range mode (only relevant when current profiling) to increase range. This bandwidth reduction makes the measurements less precise.
Beam Coordinates	In Beam coordinates, a positive velocity is directed in the same direction as the beam points. Beam 1 is marked with an "X" on the head.
Blanking	Specifies the distance from instrument head to the start of the measurement cell where no measurements take place, to give the transducers time to settle before the echo returns to the receiver. The size of the blanking area is user selectable in the software using the Start of profile parameter.
Break	A break command is used to change between the various operational modes of the instrument and to interrupt the instrument regardless of which mode it is in. When break is received in command mode, you can see that the LED is switched off for a short time.
Broadband	In this context it means using a more complex transmit pulse to improve the measurement accuracy in each ping.
Cell	One measurement cell represents the average of the return signal for a given period. The cell size and transmit pulse are of equal size. The cell is shaped like a triangle due to convolution; this is indicative of the weighting of the measurement.
Coarse Profile	Instrument setup that prioritize achieving the maximum range at the expense of reduced resolution.
Command mode	An instrument in command mode is powered up and ready to accept your instructions. If no commands are received for about five minutes, it automatically goes into Power Down Mode, unless Ethernet power is connected. LED is lit constantly when in command mode.
Compass calibration	Each compass system has been calibrated at the factory to quantify the characteristic response of the individual components and of the system as a whole. When it leaves the factory, each system can measure its tilt and the direction of its magnetic field vector accurately. However, users may disturb the magnetic field near the instrument when they deploy. Adding a battery pack and mounting the instrument with deployment hardware adds magnetic materials that change the earth's field at the instrument. The compass calibration procedure

quantifies this magnetic hard iron disturbance, and the instrument's compass algorithm then corrects for it to obtain accurate heading.

Correlation (nominal)	Nominal correlation is a function of cell size and velocity range. Nortek recommends using 50% of the max correlation as a cut-off value, beyond this point the validity of your data is questionable.
ENU Coordinates	Polar magnetic coordinates; East, North and Up. A positive east velocity goes toward east. This is also a right-handed orthogonal system.
Fine Profile	Instrument setup that prioritize the highest possible resolution at the expense of the maximum range achievable.
Firmware	Internal software of the instrument, as opposed to the instrument software running on a PC. New firmware is posted on the Nortek site. You will need to register to get access, but access is otherwise free of charge.
HR	High Resolution. With the correct firmware and license, the instrument can measure High Resolution data on the fifth, vertical beam.
Ice Draft (keel)	Measures thickness of ice. Ice draft = Water depth - Distance to Ice
Ice Drift	With the correct firmware and license, measures velocity and direction of ice drift.
Internal sampling rate	Rate of sampling for internal sensors. Refer to the specific instrument brochure for details.
LED	Light Emitting Diode, visible from the outside of the instrument. The LED can be set to blink for every sample (On), blink for the first 24 hours of deployment (On for 24h), or never (Off).
License	Different capabilities of the instrument are protected under licenses which can be purchased. Contact your sales representative for more information. Register purchased licenses while connected to your instrument under Instrument > Licenses. Licenses that are ordered with the instrument are already registered. You will not need a license when updating the firmware version.
NMEA	Standard data format defined by the National Marine Electronics Association
Noise floor	The amplitude of the internal noise of the instrument. This will limit the minimum detectable signal that can be received.
Ping	Same as a single transmit pulse.
Precision	The value given is a theoretical estimate of the precision of the velocity measurements based on how the instrument is set up. The nominal value is given for the horizontal components in a default instrument acoustic beam configuration. In order to improve the precision the user may consider one of the following options: (1) larger cell sizes, (2) longer average interval (3) reduced velocity range, or (4) increased measurement load
Sampling rate	Specifies the rate at which data is output
SDU Coordinates	Speed - Direction - Up.
Sidelobe	The acoustic beams focus most of the energy in the center of the beams, but a small amount leaks out in other directions. Transducer sidelobes are rays of acoustic energy that go in directions other than the main lobe. Because sound reflects stronger from the water surface than it does from the water, the small

	signals that travel straight to the surface can produce sufficient echo to contaminate the signal from the water.
Signal strength	Strength of return signal, presented in dB.
Sleep mode	The instrument is not actively collecting data
SNR	SNR is the Signal-to-Noise ratio and is a data quality indicator.
XYZ Coordinates	Cartesian coordinate system. A positive velocity in the X-direction goes in the direction of the X-axis arrow. The X-axis points in the same direction as beam 1. Use the right-hand-rule to remember the notation conventions for vectors. Use the first (index) finger to point in the direction of positive X-axis and the second (middle) finger to point in the direction of positive Y. The positive Z-axis will then be in the direction that the thumb points.

8.2 Communication and Ethernet

Connections between the instrument and computer can be made in one of two ways.

- Ethernet (via direct connection or router/switch)
- RS232/RS422 through the serial port. Serial communication baud rate: 300-115200, 230400, 460800, 625000, 1250000

Details about the Ethernet connection

Most instruments are shipped with the Ethernet option. The first time using the instrument, the network address needs to be properly configured for the network. The IP address can be assigned in one of the three ways:

1. Dynamic Host Configuration Protocol (DHCP): A DHCP server in the network is used to assign an IP address to the Ethernet interface.
2. AutoIP: Link-local address assignment.
3. Manually assign IP address (by the user)

As shipped, the instrument uses options 1 and 2. This means that it will try to automatically configure the IP address for the network that the instrument is plugged into.

If a DHCP server is detected it takes approximately 30 seconds to negotiate for and assign an IP address to the Ethernet interface. If you are using a broadband router, it is likely you are using a DHCP Server to assign IP Addresses. Common private network address schemes include 192.168.x.x and 10.0.x.x subnets, with the Subnet mask of 255.255.255.0 or 255.255.0.0

If a DHCP server is not detected (usually because of being directly connected to a computer) and the request for an IP Address is not fulfilled, the Signature system will automatically assign itself IP addresses using the AutoIP protocol. DHCP must first time out before the AutoIP protocol starts, so this will result in a delay of approximately 90 seconds before an IP address is finally assigned. A standard AutoIP address sits in the 169.254.x.x range, with the subnet mask being 255.255.0.0.

When using automatic IP address assignment, there is generally no way of knowing which address was assigned to the instrument. To determine the IP address assigned, the Discovery protocol is used to query instruments on the local subnet. The discovery protocol is a Nortek proprietary means for retrieving information from an AD2CP without requiring any knowledge of the IP address assigned.

There are some limitations on the Discovery protocol. It uses a special type of Ethernet packets (known as multicast packets) that may not be forwarded through routers (depending upon the router type and configuration). For that reason, we always recommend that the computer being used for Discovery ONLY be either directly connected to the instrument or connected through an Ethernet switch. Only the Discovery protocol uses multicast packets. Other communications use standard TCP/IP networking which means that the instrument can be communicated with anywhere that IP connectivity is supported once the IP address is known.

For more details about the DHCP or AutoIP there are many articles available in the public domain. These are standard protocols used by most Internet based equipment.

Routers

The discovery protocol uses multicast packets that may not work through firewalls and routers. The Time-to-Live for the multi-cast packets is set to 2. This means that at most one router can sit

between the acquisition system and instruments. The router must also be configured to support forwarding of multicast packets.

Manually assign IP address

Networked instruments can also have their IP address manually assigned. This may be useful on networks in which the discovery protocol might not work (e.g. through multiple routers or firewalls).

Network Configuration

Right-click the highlighted instrument in the Discovery function dialog to get the option of enabling DHCP or set a static IP address or IP address for a local interface (see screenshot of the dialog below).



Enable DHCP: Use a dynamically assigned IP address from a DHCP server or from AutoIP instead of a user supplied IP address. The IP address that gets assigned is also shown in this panel. AutoIP allows a local domain dynamic IP address to be assigned without the presence of a DHCP server. An instrument connected directly to the host will be assigned a special address in the 169.254.xxx.xxx address range. In order for the Windows host to also select an appropriate address in this case, the Automatic private IP address option in the Internet Protocol Version 4: Alternate Configuration menu must be enabled.

IP address: The IPv4 address to manually assign to the network interface.

Netmask: The network mask used to identify the local subnet for the network.

Gateway: The router address used to connect to machines that are on a different subnet from the instrument. The gateway must be on the same subnet as the IP address selected.

Local Interface: Shows which network interface on the computer is being used to communicate with the instrument and whether or not full IP communications can be established.

Make sure the Network adapter is configured to obtain IP address automatically and is not set to "fixed". This setting is found under Network and Sharing Center > Change Adapter Settings. Right-click the relevant network and open "Properties".

Telnet, Raw connection and FTP

The serial interface of the Doppler processor is accessible over telnet. A dedicated port can be used for ASCII only communication whereas another port provides the complete set of data, including binary data output of the measurements. This subject is covered in the [System Integrator's Guide](#), please refer to this guide for more information.

8.3 Terminal Emulator

The Terminal Emulator window allows you to communicate directly with the instrument using commands. To open the Terminal Emulator connect to the instrument using the Deployment software and click **Communication > Terminal Window** or while in the Discovery screen highlight your instrument and press Ctrl + T. You can also right-click the specific instrument and select the Terminal Emulator option.

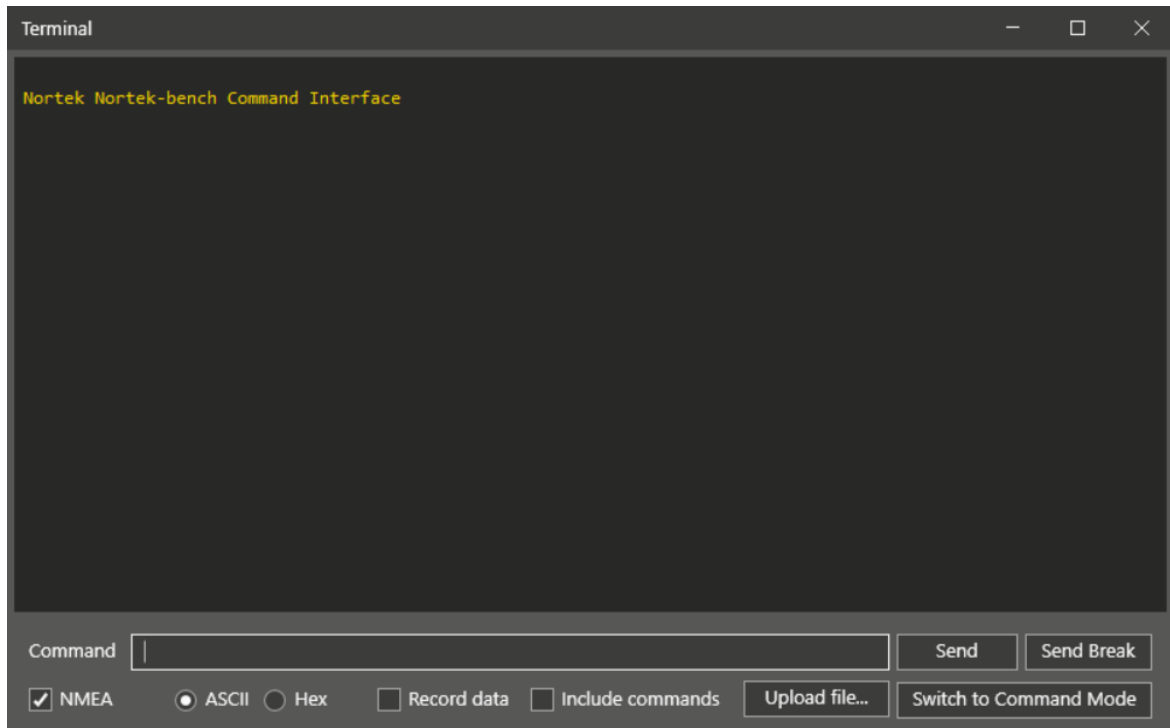

Figure 26. Terminal Emulator dialog

Command: Specify a command to send to the instrument, e.g. 'ID' to get the identification string. Note the existence of a right-click menu, which is useful if you need to edit commands. Press the Send button to send the command to the instrument. ASCII commands may be typed directly in the terminal window. Refer to the **System Integrator's Manual** for a list of commands and their syntax. Up/down arrows can be used to access the command history, and the terminal window command history are kept within sessions.

Send: Sends the command specified in the Command field.

Send Break: Sends a BREAK signal over the port. A break causes the instrument to report an identification string when it is in command mode:

[Signature1000 - NORTEK AS.](#)

[Version 2182_3 \(Sep 17 2015 18:31:28\)](#)

[COMMAND MODE](#)

[OK](#)

Protocol: Select NMEA format if applicable

Decoding

- ASCII: Display instrument output in ASCII format.
- Hex: Display instrument output in hexadecimal format.

Record data: Lets you capture the data to file.

Upload file...: Specify the name of a file containing an ASCII command to send to the instrument.

Switch to Command Mode: Put the instrument in command mode.

8.4 Web interface

The AD2CP network processor runs a web server for displaying basic information about the instrument. To access the Web site, first make sure you are connected to an instrument. Find the instrument in the **Windows Explorer > Networks** and double-click. Check out "Properties" for more details about the system. Alternatively, you can use the IP address of your instrument and type this directly in the address line in your web browser.

From the web site you have access to:

Network configuration

The Network Configuration page provides another mechanism other than Discovery for changing the saved instrument name and IP addressing information. Changing the IP address will result in the URL in the web browser having to be updated with the new IP address.

Maintenance

This area present system information and let you set the clock. Also upgrades and updates, erasing and reformatting the SD card is possible from here. The *Retrieve Support File* button is used to collect internal logs and run-time information for both processors into a single file (*.gz) that can be sent to Nortek for analysis. The instrument must be in command mode for a complete support file to be generated.

Logs

These files are useful if you need support. The *Instrument log* contains production information, the *Deployment log* contains instrument usage history. The Add Deployment Log Entry enables the user to add entries to the deployment log. The *Network* and *System logs* are mainly for debugging purposes.

Security

Password protection may be used to restrict access to the instrument. In order to enable or disable password protection, the password for the "nortek" account must be entered first (this to make sure that the password is known prior to enabling protection and to prevent protection from being disabled by an unauthorized person when enabled). Two passwords are available: one for the real-time interfaces (the ASCII, raw and data interfaces; see the Integrator's Guide) and one for FTP access to the instrument recorder. The default password for both accounts is the same as the username ("nortek" for the nortek account and "nortekftp" for the nortekftp account).

Data Download (HTTP or FTP)

Download data from the instrument. Note that this will interrupt running measurements.

8.5 Universal Plug and Play

In addition to the proprietary discovery protocol, the UPnP (universal plug and play) protocol is supported by the AD2CP platform. This allows the operating system which are UPnP capable to discover the instrument with no need for proprietary software. To view the instrument icon in Microsoft Windows, open the Network view of the computer.

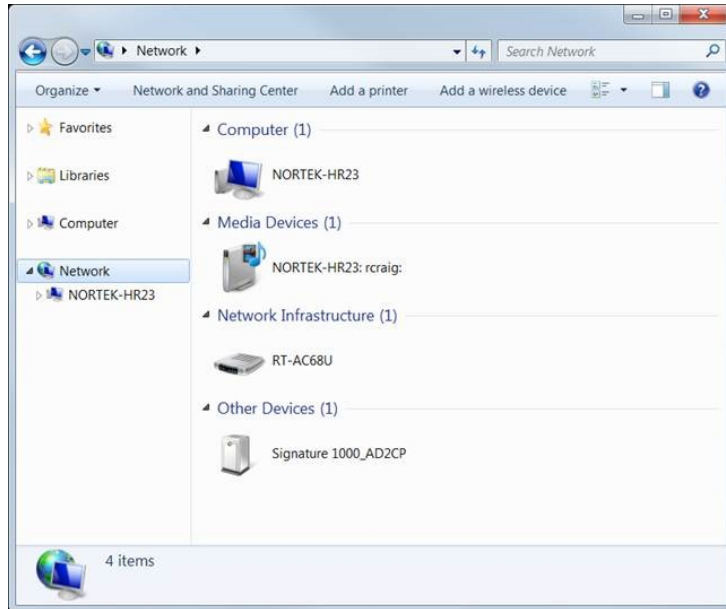

Figure 27. Network view

Double clicking on the instrument icon brings up the web page interface. Right clicking and selecting Properties gives the IP address and other instrument configuration information.

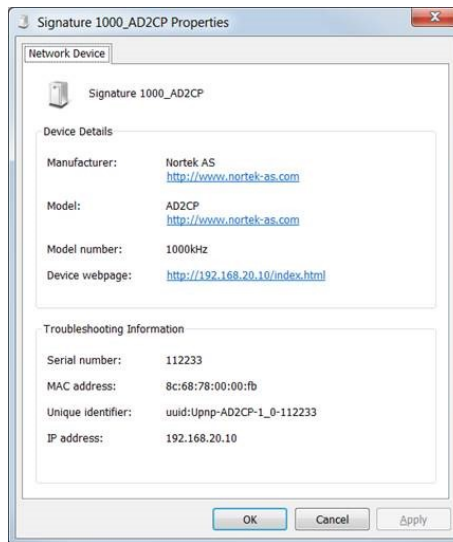

Figure 28. Properties

In order for UPnP to operate on Microsoft Windows platform, Network Discovery needs to be enabled. This is normally enabled by default on "Home" and "Work" networks but disabled on "Public" networks. To see if Network Discovery is enabled, open the Network and Sharing Center (Control Panel: Network and Internet: Network and Sharing center) and click on the *Change advanced sharing settings* selection. This will bring up the various network types (Home/Work/Public). Select the network type that the instrument is connected to and ensure that *Turn on network discovery* is

selected for that network. If the network is a public network, it is recommended that network discovery be turned off after interaction with the instrument has been completed.

8.6 Synchronization

The Signature series has advanced synchronization features built in, either using Ethernet PTP, hardware trigger signals, serially through a command or trigger on a differential RS485 compatible hardware signal. The instrument can also be configured to be a synchronization master, outputting an RS485 sync pulse. This allows several Signature instruments to synchronize their sampling with a small increase in power consumption. The various synchronized units must be identical (for example only Signature500s) and use the same ping scheme. For more details about the different synchronization options, check out the Integrators Guide - AD2CP.

8.7 Connector Pin Configurations

Other Connector Pin configurations are available upon request.

6-pin connector, Standalone, Ethernet (N2550-003, N2550-008)

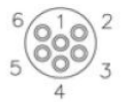
Connector on the instrument side	Pin number	Function	Wire color	Joint	Wire color	Pin number	Connector on the computer side
MCIL6M with MCDLS-F (red) Male face view: 	1	Gnd	Black		Black	Jacket	2-pin jack plug
	2	Pwr+	Red		White	Center	
	3	Rx-	White		Green	6	RJ 45 insulation connector
	4	Rx+	Blue		Green/White	3	
	5	Tx-	White		Orange	2	
	6	Tx+	Orange		Orange/White	1	

2-pin connector (N2100-608)

Connector on the instrument side	Pin number	Function	Wire color	Pin number	Connector on the external canister
MCIL2M-G2 with MCDLS-F (red)	1	Pwr +	Twisted pair, Red/Green	1	IL2M with DLSA-M(red)
	2	Gnd	Twisted pair, Black/White	2	

8-pin connector, Serial communication w/RS485 sync (N2550-021)

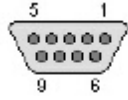
Connector on the instrument side	Pin number	Function	Wire color	Joint	Wire color	Pin number	Connector on the computer side
MCIL8M with MCDLS-F (red) 	1	Gnd	Black		Black	Jacket	2-pin jack plug
	2	Pwr+	Red		White	Center	
	3	RS232 Tx / RS422 Tx-	White		Red	2	9-pin DSUB 
	4	RS422 Tx+	Blue		White	8	
	5	RS232 Rx / RS422 Rx+	White		Orange	3	
	6	RS422 Rx-	Orange		Purple	7	
	7	Sync A	White		Blue	1	2-pin terminal block
	8	Sync B	Green		Black	2	

7-pin Souriau connector (10M), Online, Ethernet (N2550-016) - Signature500, Signature1000 and Signature250

Connector on the instrument side	Pin number	Function	Wire color	Joint	Wire color	Pin number	Connector on the computer side
7-pin Souriau (FED 10M) 	1	Gnd	Black		Black	Jacket	2-pin jack plug
	2	Pwr+	Red		White	Center	
	3	Rx-	Green		Green	6	RJ 45 insulation connector
	4	Rx+	White		Green/White	3	
	5	Tx-	Blue		Orange	2	
	6	Tx+	Orange		Orange/White	1	
	7	Shield			Uninsulated	8	

7-pin Souriau connector (14M), Ethernet (N2550-014, N2550-015) - Signature55

Connector on the instrument side	Pin number	Function	Wire color	Join t	Wire color	Pin number	Connector on the computer side
7-pin Souriau (FED 14M) Male face view: 	1	Gnd	Black		Black	Jacket	2-pin jack plug
	2	Pwr+	Red		White	Center	
	3	Rx-	Green		Green	6	RJ 45 insulation connector
	4	Rx+	White		Green/White	3	
	5	Tx-	Blue		Orange	2	
	6	Tx+	Orange		Orange/White	1	
	7	Shield			Uninsulated	8	

8.8 Proforma Invoice



NOT A SALE

Temporary export to Norway for repair

Sender (Exporter)	Receiver
Name:	Name: Nortek AS
Address:	Address: Vangkroken 2
City:	City: N-1351 Rud
Country:	Country: Norway
Tel:	Tel: +47 67 17 45 00
E-mail:	E-mail: support@nortekgroup.com
Ref:	Customs Account No.: 322 68 794 VAT/Company No.: 996 707 415 MVA

About the goods	
Date:	Description of Goods:
Delivery Terms:	No. of Units:
Delivery method:	Weight:
Tracking no:	Origin: NO
Reason for Export:	Total Value:
Return for repair	Nortek RMA No.:
Temporary	

Place:
Date:
Exporter's Name: